



5302D

NPN SILICON TRANSISTOR

HIGH VOLTAGE NPN TRANSISTOR WITH DIODE

■ DESCRIPTION

The UTC **5302D** are series of NPN silicon planar transistor with diode and its suited to be used in power amplifier applications.

■ FEATURES

- * Internal free-wheeling diode
- * Makes efficient anti-saturation operation
- * Low variable storage-time spread
- * Low base drive
- * Very suitable for half bridge light ballast application

■ SYMBOL

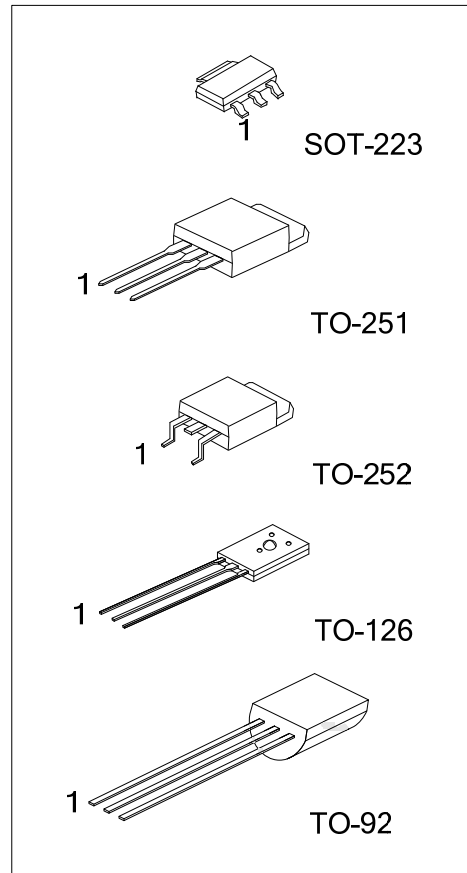
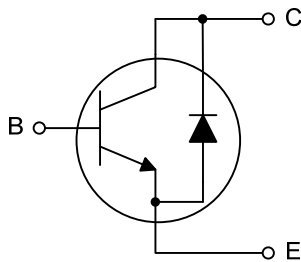

■ ORDERING INFORMATION

Ordering Number		Package	Pin Assignment			Packing
Lead Free	Halogen Free		1	2	3	
-	5302DG-AA3-R	SOT-223	B	C	E	Tape Reel
5302DL-T60-K	5302DG-T60-K	TO-126	B	C	E	Bulk
5302DL-T92-B	5302DG-T92-B	TO-92	E	C	B	Tape Box
5302DL-T92-K	5302DG-T92-K	TO-92	E	C	B	Bulk
5302DL-T92-R	5302DG-T92-R	TO-92	E	C	B	Tape Reel
5302DL-TM3-T	5302DG-TM3-T	TO-251	B	C	E	Tube
5302DL-TN3-R	5302DG-TN3-R	TO-252	B	C	E	Tape Reel

Note: Pin assignment: E: Emitter B: Base C: Collector

<p>5302DL-T60-T</p> <p>(1) Packing Type</p> <p>(2) Package Type</p> <p>(3) Green Package</p>	<p>(1) B: Tape Box, K: Bulk, T: Tube, R: Tape Reel</p> <p>(2) T60: TO-126, T92: TO-92, TM3: TO-251, TN3: TO-252, AA3: SOT-223</p> <p>(3) L: Lead Free, G: Halogen Free and Lead Free</p>
--	--

5302D

NPN SILICON TRANSISTOR

MARKING

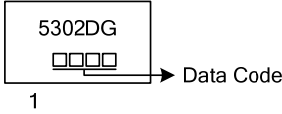
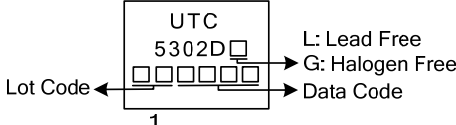
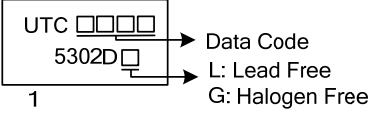
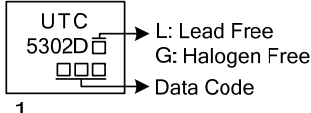
SOT-223	TO-251 / TO-252
 <p>5302DG □□□ → Data Code 1</p>	 <p>UTC 5302D □ □□□□□ → Data Code Lot Code ← 1 L: Lead Free G: Halogen Free</p>
TO-126	TO-92
 <p>UTC □□□ → Data Code 5302D □ → L: Lead Free 1 → G: Halogen Free</p>	 <p>UTC 5302D □ □□□ → Data Code 1 L: Lead Free G: Halogen Free</p>

■ ABSOLUTE MAXIMUM RATING ($T_A=25^{\circ}\text{C}$, unless otherwise specified)

PARAMETER		SYMBOL	RATINGS	UNIT
Collector-Base Voltage		V_{CB0}	800	V
Collector-Emitter Voltage		V_{CEO}	400	V
Emitter-Base Voltage		V_{EBO}	10	V
Collector Current		I_C	2	A
Collector Peak Current ($t_P<5\text{ms}$)		I_{CM}	4	A
Base Current		I_B	1	A
Base Peak Current ($t_P<5\text{ms}$)		I_{BM}	2	A
Power Dissipation ($T_C\leq 25^{\circ}\text{C}$)	TO-126	P_D	12.5	W
	TO-92		1.6	
	TO-251/ TO-252		25	
	SOT-223		1	
Junction Temperature		T_J	+150	$^{\circ}\text{C}$
Storage Temperature		T_{STG}	-65 ~ +150	$^{\circ}\text{C}$

Note: Absolute maximum ratings are those values beyond which the device could be permanently damaged. Absolute maximum ratings are stress ratings only and functional device operation is not implied.

■ THERMAL DATA

PARAMETER		SYMBOL	RATINGS	UNIT
Junction to Ambient	TO-126	θ_{JA}	122	$^{\circ}\text{C/W}$
	TO-92		160	
	TO-251/ TO-252		100	
	SOT-223		175	
Junction to Case	TO-126	θ_{JC}	10	$^{\circ}\text{C/W}$
	TO-92		80	
	TO-251/ TO-252		5	
	SOT-223		125	

■ ELECTRICAL CHARACTERISTICS ($T_A = 25^{\circ}\text{C}$, unless otherwise specified)

PARAMETER	SYMBOL	TEST CONDITIONS	MIN	TYP	MAX	UNIT
OFF CHARACTERISTICS						
Collector-Emitter Breakdown Voltage	BV_{CEO}	$I_C=10\text{mA}$, $I_E=0$ (Note)	400			V
Collector-Base Breakdown Voltage	BV_{CBO}	$I_C=1\text{mA}$, $I_B=0$	800			V
Emitter-Base Breakdown Voltage	BV_{EBO}	$I_E=1\text{mA}$, $I_C=0$	10			V
Collector Cutoff Current	I_{CBO}	$V_{CB}=800\text{V}$, $I_E=0$			1	μA
Emitter Cutoff Current	I_{EBO}	$V_{EB}=9\text{V}$, $I_C=0$			1	μA
ON CHARACTERISTICS						
DC Current Gain	h_{FE1}	$V_{CE}=5\text{V}$, $I_C=10\text{mA}$	10			
	h_{FE2}	$V_{CE}=5\text{V}$, $I_C=400\text{mA}$	10		40	
	h_{FE3}	$V_{CE}=5\text{V}$, $I_C=1\text{A}$	5			
Collector-Emitter Saturation Voltage	$V_{CE(SAT1)}$	$I_C=0.5\text{A}$, $I_B=0.1\text{A}$ (Note)			0.5	V
	$V_{CE(SAT2)}$	$I_C=1\text{A}$, $I_B=0.25\text{A}$ (Note)		1.1	1.5	
Base-Emitter Saturation Voltage	$V_{BE(SAT1)}$	$I_C=0.5\text{A}$, $I_B=0.1\text{A}$ (Note)			1.1	V
	$V_{BE(SAT2)}$	$I_C=1\text{A}$, $I_B=0.25\text{A}$ (Note)			1.2	
SWITCHING CHARACTERISTICS						
Turn On Time	t_{ON}	$V_{CC}=250\text{V}$, $I_C=1\text{A}$,		0.15	0.3	μS
Fall Time	t_F	$I_{B1}=I_{B2}=0.2\text{A}$, $t_P=25\mu\text{S}$		0.2	0.4	μS
Storage Time	t_{STG}	Duty Cycle<1%		0.5	0.9	μS
DIODE						
Forward Voltage Drop	V_F	$I_C=1\text{A}$			1.4	V
Fall Time	t_F	$I_C=1\text{A}$			800	μS

Note: Pulsed duration = $300\mu\text{S}$, Duty cycle $\leq 2\%$

TYPICAL CHARACTERISTICS

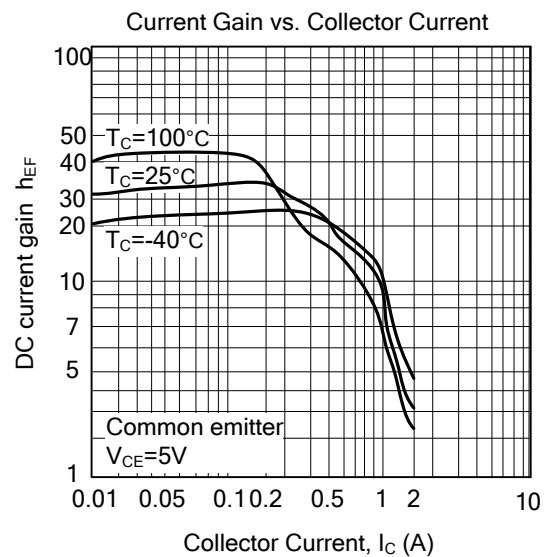
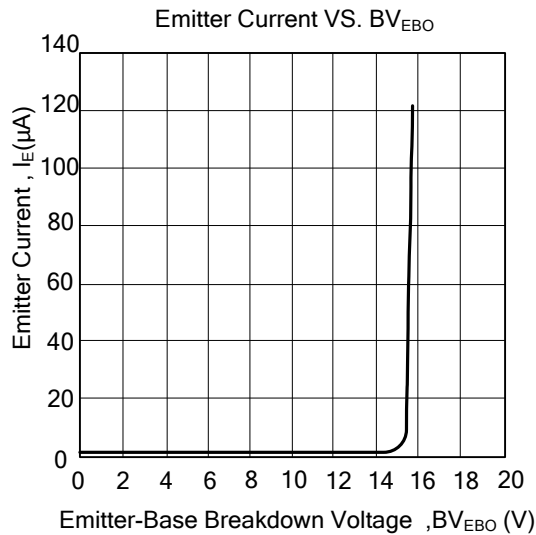
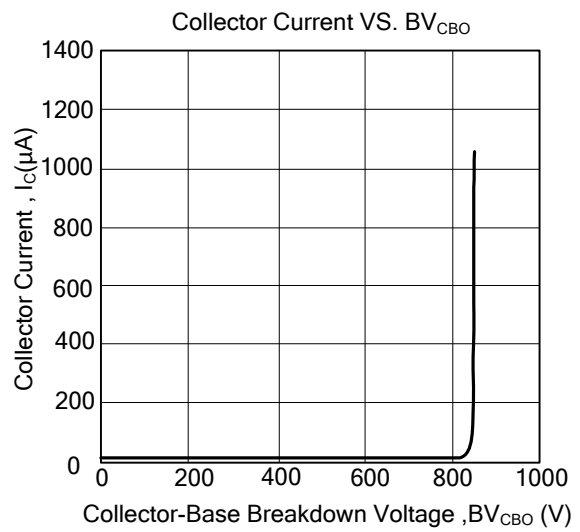
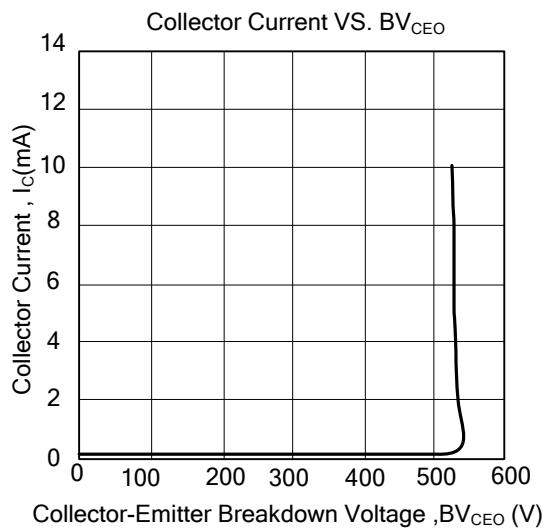

UTC assumes no responsibility for equipment failures that result from using products at values that exceed, even momentarily, rated values (such as maximum ratings, operating condition ranges, or other parameters) listed in products specifications of any and all UTC products described or contained herein. UTC products are not designed for use in life support appliances, devices or systems where malfunction of these products can be reasonably expected to result in personal injury. Reproduction in whole or in part is prohibited without the prior written consent of the copyright owner. The information presented in this document does not form part of any quotation or contract, is believed to be accurate and reliable and may be changed without notice.

X-ON Electronics

Largest Supplier of Electrical and Electronic Components

Click to view similar products for [Bipolar Transistors - BJT category](#):

Click to view products by [Unisonic manufacturer](#):

Other Similar products are found below :

[619691C](#) [MCH4017-TL-H](#) [MJ15024/WS](#) [MJ15025/WS](#) [BC546/116](#) [BC556/FSC](#) [BC557/116](#) [BSW67A](#) [HN7G01FU-A\(T5L,F,T](#)
[NJVMJD148T4G](#) [NSVMMBT6520LT1G](#) [NTE187A](#) [NTE195A](#) [NTE2302](#) [NTE2330](#) [NTE2353](#) [NTE316](#) [IMX9T110](#) [NTE63](#) [NTE65](#)
[C4460](#) [SBC846BLT3G](#) [2SA1419T-TD-H](#) [2SA1721-O\(TE85L,F\)](#) [2SA1727TLP](#) [2SA2126-E](#) [2SB1202T-TL-E](#) [2SB1204S-TL-E](#) [2SC5488A-](#)
[TL-H](#) [2SD2150T100R](#) [SP000011176](#) [FMC5AT148](#) [2N2369ADCSM](#) [2SB1202S-TL-E](#) [2SC2412KT146S](#) [2SC4618TLN](#) [2SC5490A-TL-H](#)
[2SD1816S-TL-E](#) [2SD1816T-TL-E](#) [CMXT2207 TR](#) [CPH6501-TL-E](#) [MCH4021-TL-E](#) [BC557B](#) [TTC012\(Q\)](#) [BULD128DT4](#) [JANTX2N3810](#)
[Jantx2N5416](#) [US6T6TR](#) [KSF350](#) [068071B](#)