



LM386

LINEAR INTEGRATED CIRCUIT

LOW VOLTAGE AUDIO POWER AMPLIFIER

DESCRIPTION

The UTC **LM386** is a power amplifier, designed for use in low voltage consumer applications. The gain is internally set to 20 to keep external part count low, but the addition of an external resistor and capacitor between pin 1 and pin 8 will increase the gain to any value up from 20 to 200 dB.

The inputs are ground referenced while the output automatically biases to one-half the supply voltage. The quiescent power drain is only 24 milliwatts when operating from a 6 volt supply, making the **LM386** ideal for battery operation.

FEATURES

- *Battery Operation
- *Minimum External Parts
- *Wide Supply Voltage Range: 4V~12V
- *Low Quiescent Current Drain:4mA
- *Voltage Gains: 20~200dB
- *Ground Referenced Input
- *Self-Centering Output Quiescent Voltage
- *Low Distortion: 0.2% ($A_v=20$, $V_s=6V$, $R_L=8\Omega$, $P_O=125mW$, $f=1kHz$)

ORDERING INFORMATION

Ordering Number		Package	Packing
Lead Free	Halogen Free		
LM386L-D08-T	LM386G-D08-T	DIP-8	Tube
-	LM386G-S08-R	SOP-8	Tape Reel
-	LM386G-P08-R	TSSOP-8	Tape Reel

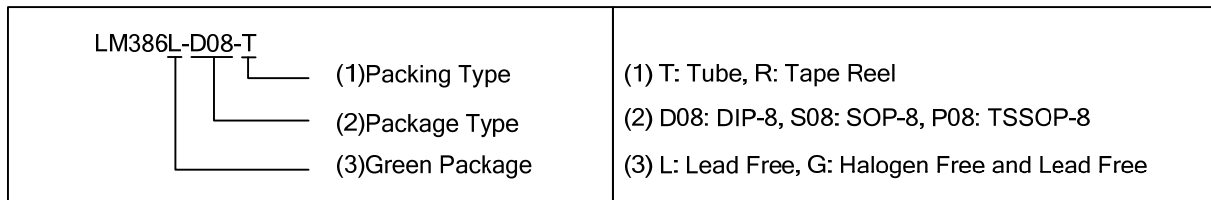

MARKING

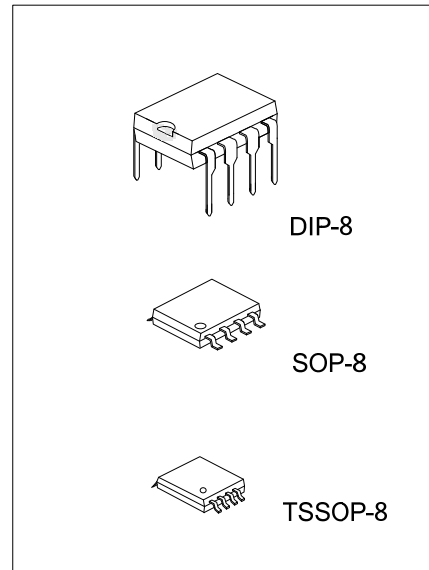
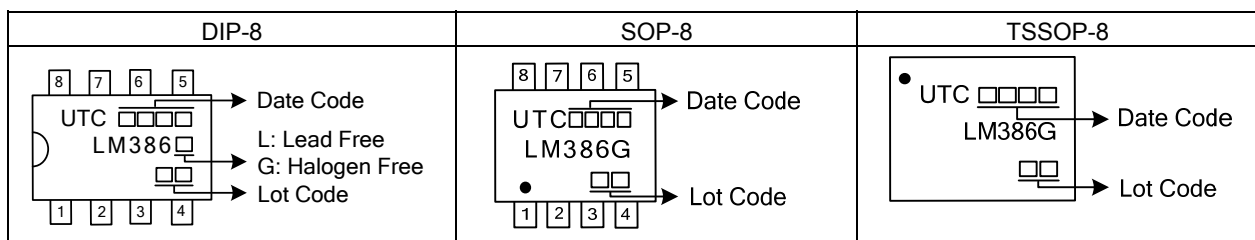

■ PIN CONFIGURATION

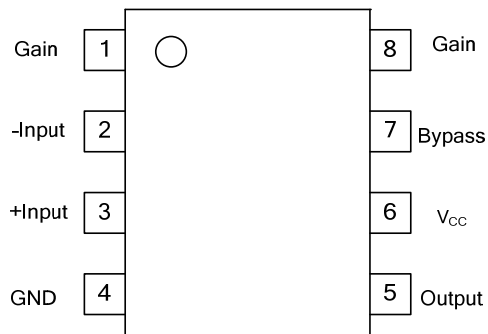

■ BLOCK DIAGRAM

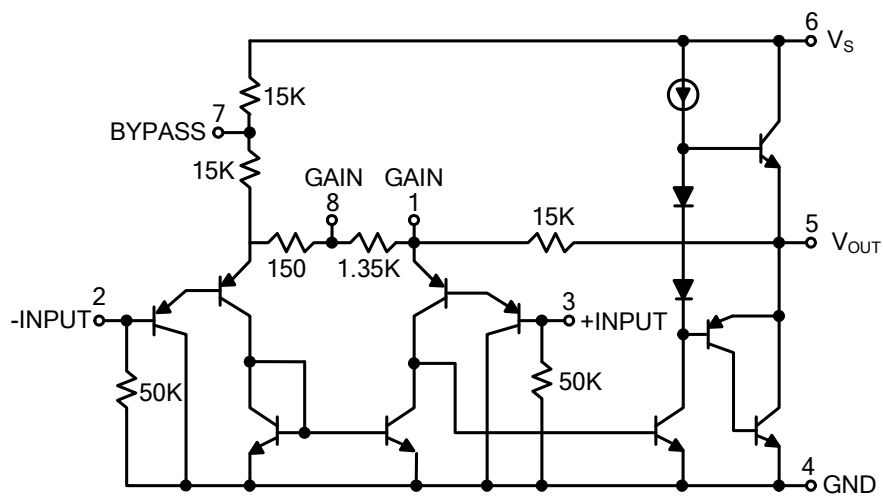

■ ABSOLUTE MAXIMUM RATINGS

PARAMETER		SYMBOL	RATINGS	UNIT
Supply Voltage		V_{CC}	15	V
Input Voltage		V_{IN}	-0.4V ~ +0.4V	V
Power Dissipation	DIP-8	P_D	1250	mW
	SOP-8		600	
	TSSOP-8		600	
Operating Temperature		T_{OPR}	-25 ~ +85	°C
Junction Temperature		T_J	+125	°C
Storage Temperature		T_{STG}	-40 ~ +150	°C

Note:1. Absolute maximum ratings are stress ratings only and functional device operation is not implied. The device could be damaged beyond Absolute maximum ratings.

■ ELECTRICAL CHARACTERISTICS ($T_A=25^\circ\text{C}$, unless otherwise specified.)

PARAMETER	SYMBOL	TEST CONDITIONS	MIN	TYP	MAX	UNIT
Operating Supply Voltage	V_S		4		12	V
Quiescent Current	I_Q	$V_S=6V, V_{IN}=0$		4	8	mA
Output Power	P_{OUT}	$V_S=6V, R_L=8\Omega, THD=10\%$	250	325		mW
		$V_S=9V, R_L=8\Omega, THD=10\%$	500	700		
Voltage Gain	G_V	$V_S=6V, f=1\text{kHz}$ 10 μF from pin 1 to pin 8		26		dB
					46	
Bandwidth	BW	$V_S=6V$, Pin1 and pin 8 open		300		kHz
Total Harmonic Distortion	THD	$P_{OUT}=125\text{mW}, V_S=6V, f=1\text{kHz}$ $R_L=8\Omega$ pin1 and pin 8 open		0.2		%
Rejection Ratio	RR	$V_S=6V, f=1\text{kHz}, C_{BYPASS}=10\mu\text{F}$ pin1 and pin 8 open, Referred to output		50		dB
Input Resistance	R_{IN}			50		k Ω
Input Bias Current	I_{BIAS}	$V_S=6V$ Pin2 and pin 3 open		250		nA

■ APPLICATION NOTES

GAIN CONTROL

To make the **LM386** a more versatile amplifier, two pins (1 and 8) are provided for gain control. With pins 1 and 8 open the 1.35 k Ω resistor sets the gain at 20 (26dB). If a capacitor is put from pin 1 to 8, bypassing the 1.35 k Ω resistor, the gain will go up to 200(46dB). If a resistor is placed in series with the capacitor, the gain can be set to any value from 20 to 200. Gain control can also be done by capacitively coupling a resistor (or FET) from pin 1 to ground.

Additional external components can be placed in parallel with the internal feedback resistors to tailor the gain and frequency response for individual applications. For example we can compensate poor speaker bass response by frequency shaping the feedback path. This is done with a series RC from pin 1 to 5 (paralleling the internal 15 k Ω resistor). For 6 dB effective bass boost: R=15 k Ω , the lowest value for good stable operation is R=10 k Ω , if pin 8 is open, If pins 1 and 8 are bypassed then R as low as 2 k Ω can be used. This restriction is because the amplifier is only compensated for closed-loop gains greater than 9.

INPUT BIASING

The schematic shows that both inputs are biased to ground with a 50 k Ω resistor. The base current of the input transistors is about 250nA, so the inputs are at about 12.5mW when left open. If the dc source resistance driving the **LM386** is higher than 250 k Ω it will contribute very little additional offset (about 2.5mW at the input, 50mW at the output). If the dc source resistance is less than 10 k Ω , then shorting the unused input to ground will keep the offset low (about 2.5mV at the input, 50 mV at the output). For dc source resistances between these values we can eliminate excess offset by putting a resistor from the unused input to ground, equal in value to the dc source resistance. Of course all offset problems are eliminated if the input is capacitively coupled.

When using the **LM386** with higher gains (bypassing the 1.35 k Ω resistor between pins 1 and 8) it is necessary to bypass the unused input, preventing degradation of gain and possible instabilities. This is done with a 0.1 μ F capacitor or a short to ground depending on the dc source resistance on the driven input.

TYPICAL CHARACTERISTICS

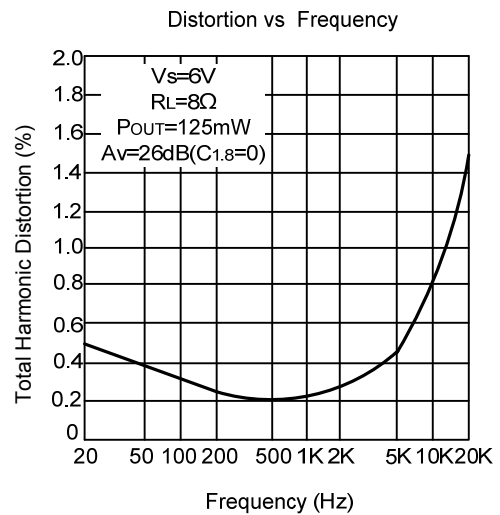
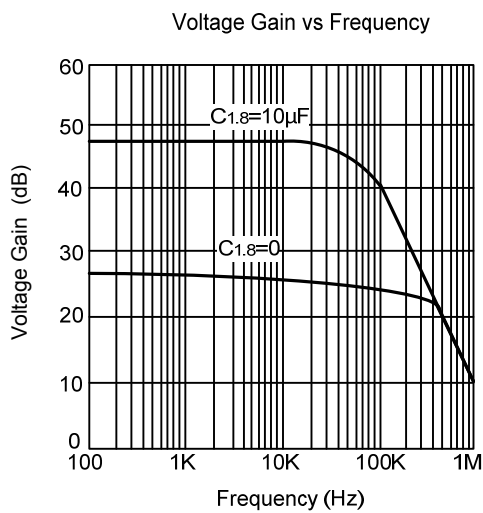
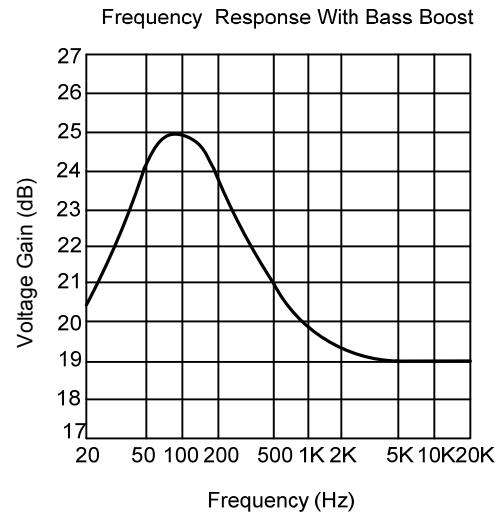
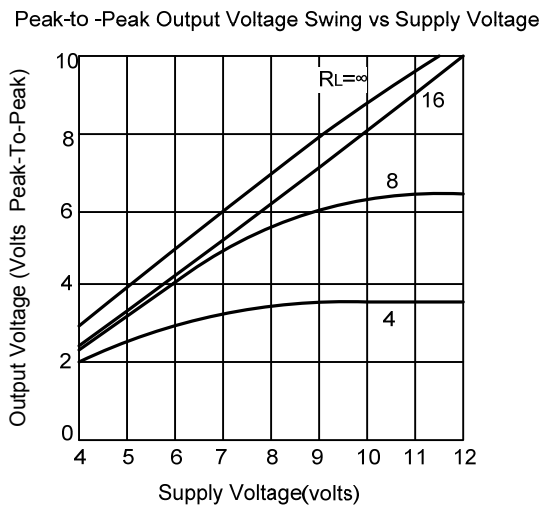
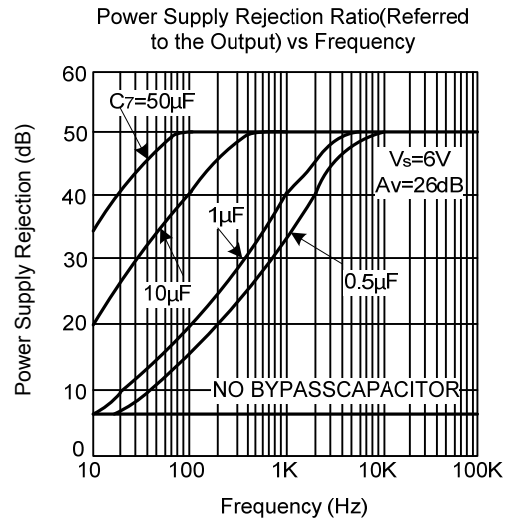
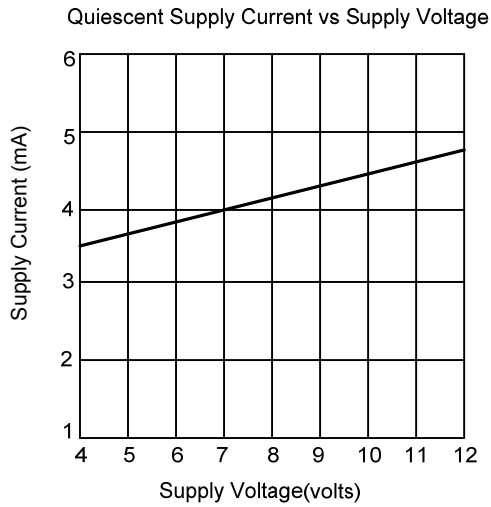

■ TYPICAL CHARACTERISTICS(cont.)

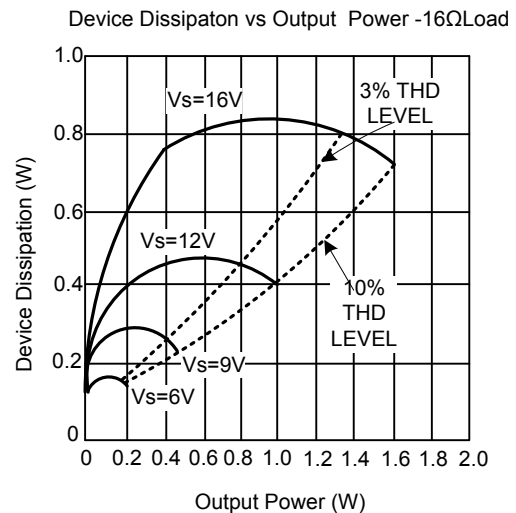
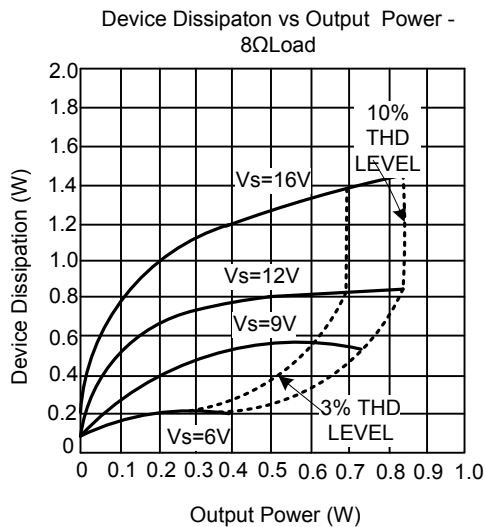
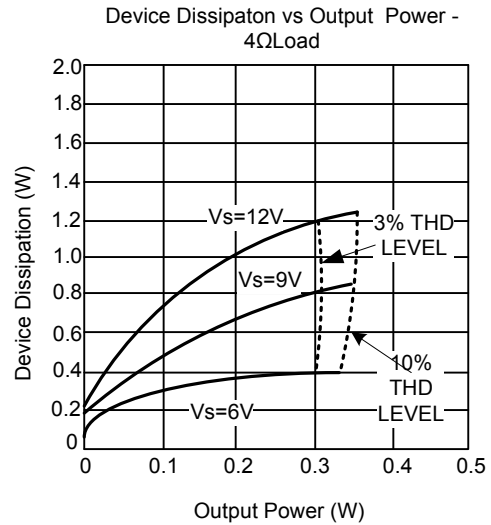
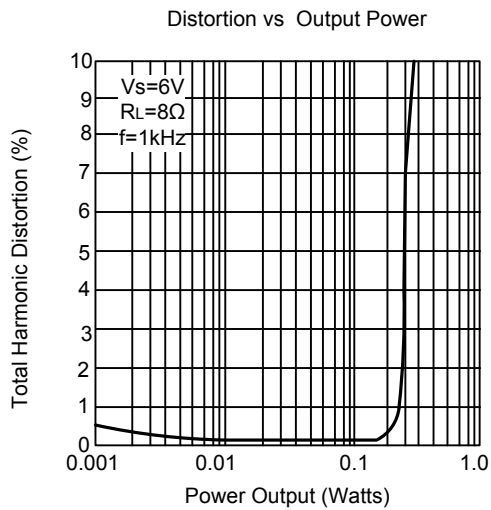

UTC assumes no responsibility for equipment failures that result from using products at values that exceed, even momentarily, rated values (such as maximum ratings, operating condition ranges, or other parameters) listed in products specifications of any and all UTC products described or contained herein. UTC products are not designed for use in life support appliances, devices or systems where malfunction of these products can be reasonably expected to result in personal injury. Reproduction in whole or in part is prohibited without the prior written consent of the copyright owner. The information presented in this document does not form part of any quotation or contract, is believed to be accurate and reliable and may be changed without notice.

X-ON Electronics

Largest Supplier of Electrical and Electronic Components

Click to view similar products for [Audio Amplifiers](#) category:

Click to view products by [Unisonic](#) manufacturer:

Other Similar products are found below :

[LV3313PM-TLM-E](#) [LV47002P-E](#) [AZ386MTR-E1](#) [NCP2811AFCT1G](#) [NCP2890AFCT2G](#) [IS31AP4915A-QFLS2-TR](#) [TDA1591T](#) [AS3561-BWLT-500](#) [TDA7563AH](#) [TDA7850H](#) [TS2012EIJT](#) [NCP2809BMUTXG](#) [NJW1157BFC2](#) [IS31AP4996-GRLS2-TR](#) [NCP2823BFCT1G](#) [LA4450L-E](#) [IS31AP2036A-CLS2-TR](#) [TDA7563ASMTR](#) [AS3561-DWLT](#) [MP1720DH-12-LF-P](#) [SABRE9601K](#) [THAT1646W16-U](#) [PAM8965ZLA40-13](#) [TSDP10XX1NLGXZBX](#) [TSDP11XX1NKGIZBX](#) [TSDP10XX1NKGIZBX](#) [BD37532FV-E2](#) [BD5638NUX-TR](#) [BD37543FS-E2](#) [BD3814FV-E2](#) [TPA3110LD2PWPR](#) [AS3435-EQFP](#) [VA2218TSG28](#) [TAS5766MRMTR](#) [TPA3140D2PWPR](#) [TS2007EIJT](#) [IS31AP2005-DLS2-TR](#) [SSM2518CPZ-R7](#) [TFA9879HN/N1,118](#) [AS3410-EQFP-500](#) [FDA4100LV](#) [TPA3140D2PWP](#) [BD3812F-E2](#) [MAX98306ETD+T](#) [TS4994EIJT](#) [NCP2820FCT1G](#) [NCP4894FCT1G](#) [NCP2823AFCT2G](#) [NCS2211MNTXG](#) [CPA2233CQ16-A1](#)