



MC34072

LINEAR INTEGRATED CIRCUIT

HIGH SLEW RATE, WIDE BANDWIDTH , SINGLE SUPPLY OPERATIONAL AMPLIFIER

DESCRIPTION

The UTC **MC34072** offer 4.5MHz of gain bandwidth product, 13V/ μ s slew rate and fast setting time without the use of JFET device technology. Although it can be operated from split supplies, it is particularly suited for single supply operation, since the common mode input voltage range includes ground potential (V_{EE}). With A Darlington input stage, it exhibits high input resistance, low input offset voltage and high gain. The all NPN output stage, characterized by no deadband crossover distortion and large output voltage swing, provides high capacitance drive capability, excellent phase and gain margins, low open loop high frequency output impedance and symmetrical source/sink AC frequency response.

FEATURES

- * Wide bandwidth: 4.5 MHz
- * High slew rate: 13V/ μ s
- * Fast settling time: 1.1 μ s to 0.1%
- * Wide single supply operation: 3.0V to 44V
- * Wide input common mode voltage range:
Includes ground (V_{EE})
- * Low input offset voltage: 3.0mV maximum
- * Large output voltage swing: -14.7V to +14V
(with \pm 15V supplies)
- * Large capacitance drive Capability: 0pF to 10,000 pF
- * Low total harmonic distortion: 0.02%
- * Excellent phase margin: 60°
- * Excellent gain margin: 12dB
- * Output short circuit protection

ORDERING INFORMATION

Ordering Number		Package	Packing
Lead Free Plating	Halogen Free		
MC34072L-D08-T	MC34072G-D08-T	DIP-8	Tube
MC34072L-S08-R	MC34072G-S08-R	SOP-8	Tape Reel
MC34072L-P08-R	MC34072G-P08-R	TSSOP-8	Tape Reel

<p>MC34072L-D08-T</p> <p>(1)Packing Type (2)Package Type (3)Lead Plating</p>	<p>(1) T: Tube, R: Tape Reel (2) D08: DIP-8, S08: SOP-8, P08: TSSOP-8 (3) L: Lead Free, G: Halogen Free</p>
--------------------------------------------------------------------------------------	---------------------------------------------------------------------------------------------------------------------

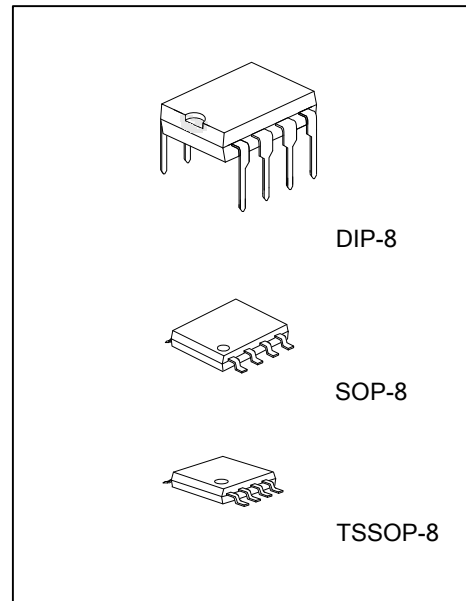

MARKING INFORMATION

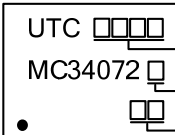
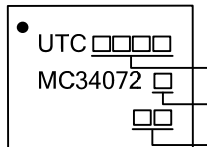
PACKAGE	MARKING
SOP-8 DIP-8	 <ul style="list-style-type: none"> UTC □□□□ → Date Code MC34072 □ → L: Lead Free □ → G: Halogen Free □ → Lot Code
TSSOP-8	 <ul style="list-style-type: none"> UTC □□□□ → Date Code MC34072 □ → L: Lead Free □ → G: Halogen Free □ → Lot Code

PIN DESCRIPTION

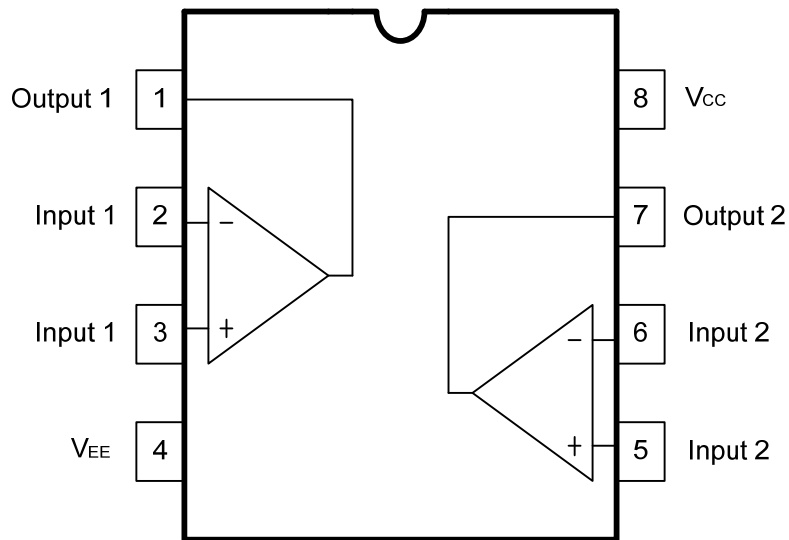

■ REPRESENTATIVE SCHEMATIC DIAGRAM

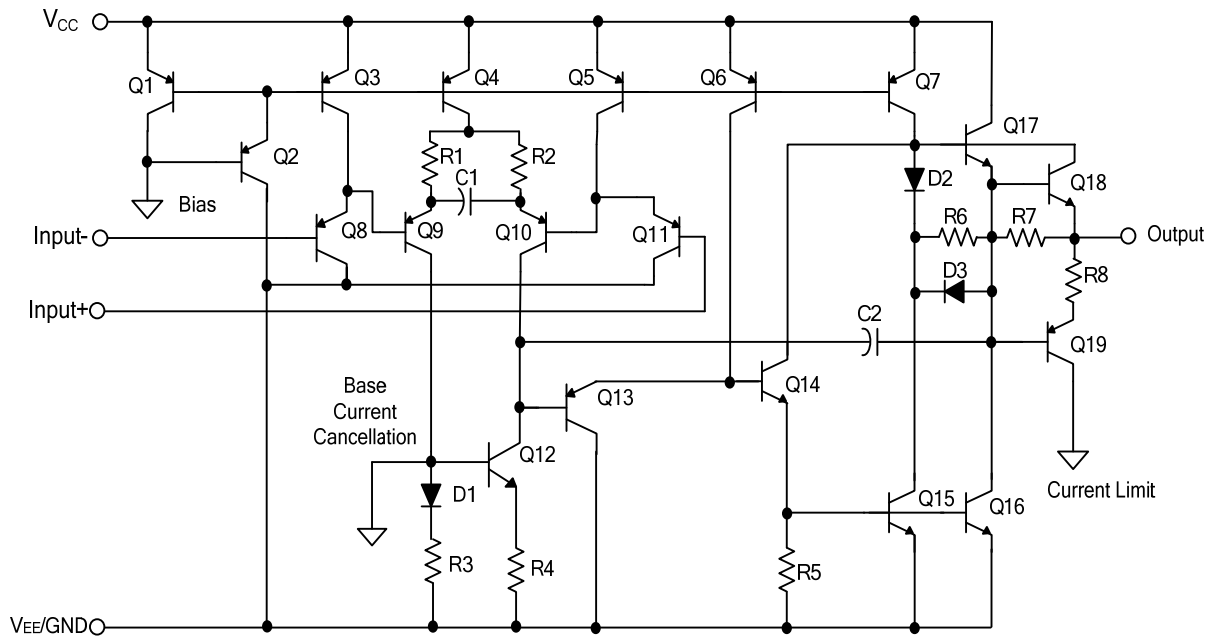

■ ABSOLUTE MAXIMUM RATINGS ($T_A = 25^\circ\text{C}$, unless otherwise specified)

PARAMETER	SYMBOL	RATINGS	UNIT
Supply Voltage (from V_{EE} to V_{CC})	V_S	+44 or ± 22	V
Differential Input Voltage	$V_{I(DIFF)}$	Note 1	V
Input Voltage	V_{IN}	Note 1	V
Output Short Circuit Duration (Note 2)	t_{SC}	Indefinite	sec
Junction Temperature	T_J	+150	$^\circ\text{C}$
Operating Temperature	T_{OPR}	-20 ~ +85	$^\circ\text{C}$
Storage Temperature Range	T_{STG}	-40~ +150	$^\circ\text{C}$

Note: 1. Either or both input voltages should not exceed the magnitude of V_{CC} or V_{EE} .

2. Power dissipation must be considered to ensure maximum junction temperature (T_J) is not exceeded.

3. Absolute maximum ratings are those values beyond which the device could be permanently damaged.

Absolute maximum ratings are stress ratings only and functional device operation is not implied.

■ ELECTRICAL CHARACTERISTICS

($V_{CC}=+15\text{V}$, $V_{EE}=-15\text{V}$, R_L =connected to ground, unless otherwise specified)

PARAMETER	SYMBOL	TEST CONDITIONS	MIN	TYP	MAX	UNIT
Input Offset Voltage	$V_{I(OFF)}$	$R_S=100\Omega$, $V_{CM}=0\text{V}$, $V_{OUT}=0\text{V}$	$V_{CC}=+15\text{V}$, $V_{EE}=-15\text{V}$, $T_A=+25^\circ\text{C}$	0.5	3.0	mV
			$V_{CC}=+5\text{V}$, $V_{EE}=0\text{V}$, $T_A=+25^\circ\text{C}$	0.5	3.0	mV
			$V_{CC}=+15\text{V}$, $V_{EE}=-15\text{V}$, $T_A=0^\circ\text{C}$ to 70°C		5.0	mV
Average Temperature Coefficient of Input Offset Voltage	$\Delta V_{IO}/\Delta T$	$R_S=10\Omega$, $V_{CM}=0\text{V}$, $V_{OUT}=0\text{V}$, $T_A=0^\circ\text{C}$ to 70°C		10		$\mu\text{V}/^\circ\text{C}$
Input Bias Current	$I_{I(BIAS)}$	$V_{CM}=0\text{V}$, $V_{OUT}=0\text{V}$	$T_A=+25^\circ\text{C}$	100	500	nA
			$T_A=0^\circ\text{C}$ to 70°C			700
Input Offset Current	$I_{I(OFF)}$	$V_{CM}=0\text{V}$, $V_{OUT}=0\text{V}$	$T_A=+25^\circ\text{C}$	6.0	50	nA
			$T_A=0^\circ\text{C}$ to 70°C			300
Input Common Mode Voltage	V_{ICR}	$T_A=+25^\circ\text{C}$	V_{EE} to $(V_{CC}-1.8)$			V
		$T_A=0^\circ\text{C}$ to 70°C	V_{EE} to $(V_{CC}-2.2)$			V
Large Signal Voltage Gain	G_V	$V_{OUT}=\pm 10\text{V}$, $R_L=2.0\text{k}\Omega$	$T_A=+25^\circ\text{C}$	50	100	V/mV
			$T_A=0^\circ\text{C}$ to 70°C	25		
Output Voltage Swing ($V_{ID}=\pm 1.0\text{V}$)	V_{OH}	$V_{CC}=+5.0\text{V}$, $V_{EE}=0\text{V}$, $R_L=2.0\text{k}\Omega$, $T_A=+25^\circ\text{C}$	3.7	4.0		V
		$V_{CC}=+15.0\text{V}$, $V_{EE}=-15\text{V}$, $R_L=10\text{k}\Omega$, $T_A=+25^\circ\text{C}$	13.6	14		V
		$V_{CC}=+15.0\text{V}$, $V_{EE}=-15\text{V}$, $R_L=2.0\text{k}\Omega$, $T_A=0^\circ\text{C}$ to 70°C	13.4			V
Output Voltage Swing ($V_{ID}=\pm 1.0\text{V}$)	V_{OL}	$V_{CC}=+5.0\text{V}$, $V_{EE}=0\text{V}$, $R_L=2.0\text{k}\Omega$, $T_A=+25^\circ\text{C}$		0.1	0.3	V
		$V_{CC}=+15.0\text{V}$, $V_{EE}=-15\text{V}$, $R_L=10\text{k}\Omega$, $T_A=+25^\circ\text{C}$		-14.7	-14.3	V
		$V_{CC}=+15.0\text{V}$, $V_{EE}=-15\text{V}$, $R_L=2.0\text{k}\Omega$, $T_A=0^\circ\text{C}$ to 70°C			-13.5	V
Output Short Circuit current	I_{SC}	$V_{I(DIFF)}=1.0\text{V}$, $V_{OUT}=0\text{V}$, $T_A=25^\circ\text{C}$	Source	10	30	mA
			Sink	20	30	
Common Mode Rejection	CMR	$R_S \leq 10\text{k}\Omega$, $V_{CM}=V_{ICR}$, $T_A=25^\circ\text{C}$	80	97		dB
Power Supply Rejection ($R_S=100\Omega$)	SVR	$V_{CC}/V_{EE}=\pm 16.5\text{V}/-16.5\text{V}$ to $\pm 13.5/-13.5\text{V}$, $T_A=25^\circ\text{C}$	80	97		dB

■ ELECTRICAL CHARACTERISTICS(Cont.)

PARAMETER	SYMBOL	TEST CONDITIONS	MIN	TYP	MAX	UNIT
Power Supply Current (Per Amplifier, No Load)	I _D	V _{CC} =+5.0V, V _{EE} =0V, V _{OUT} =+2.5V, Ta=+25°C		1.6	2.0	mA
		V _{CC} =+15.0V, V _{EE} =-15V, V _{OUT} =0V, Ta=+25°C		1.9	2.5	mA
		V _{CC} =+15.0V, V _{EE} =-15V, V _{OUT} =0V, Ta=0°C to 70°C			2.8	mA
Slew Rate	SR	V _{IN} =-10V to +10V, R _L =2.0kΩ, C _L =500pF	Av=+1.0	8.0	10	V/μs
			Av=-1.0		13	
Setting Time	ts	10 Setp, Av=-1.0 to 0.1% (+1/2 LSB of 9-Bits) to 0.01% (+1/2 LSB of 12-Bits)		1.1 2.2		μs
Gain Bandwidth Product	GB _W	f=100kHz	3.5	4.5		MHz
Power Bandwidth	B _W	Av=+1.0, R _L =2kΩ, V _{OUT} =20Vpp, THD=5.0%		160		kHz
Phase Margin	fm	R _L =2kΩ		60		Deg
		R _L =2kΩ, C _L =300pF		40		Deg
Gain Margin	Am	R _L =2kΩ		12		dB
		R _L =2kΩ, C _L =300pF		4		dB
Equivalent Input Noise Voltage	eN	Rs=100Ω, f=1.0kHz		32		nV/√Hz
Equivalent Input Noise Current	eN	f=1.0kHz		0.22		pA/√Hz
Differential Input Resistance	R _{IN}	V _{CM} =0V		150		MΩ
Differential Input Capacitance	C _{IN}	V _{CM} =0V		2.5		pF
Total Harmonic distortion	THD	Av=+10, R _L =2.0kΩ, 2.0Vpp≤V _{OUT} ≤20Vpp, f=10kHz		0.02		%
Channel Separation		f=10kHz		120		dB
Open Loop Output Impedance	I _{Zol}	f=1.0MHz		30		W

TYPICAL CHARACTERISTICS

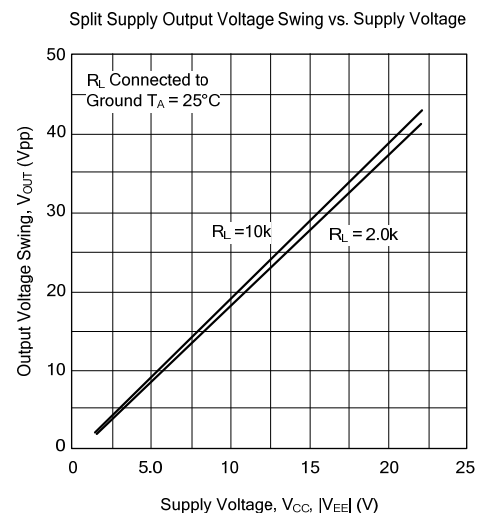
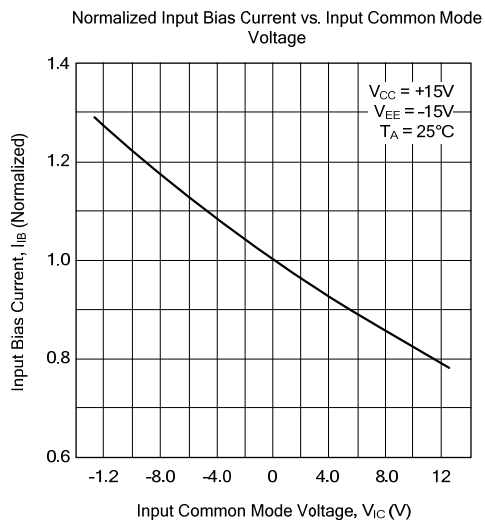
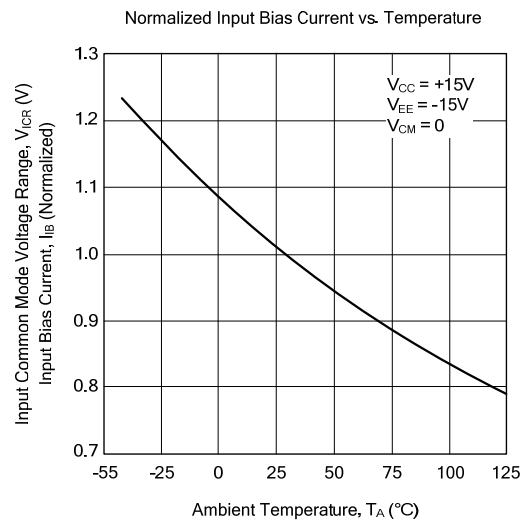
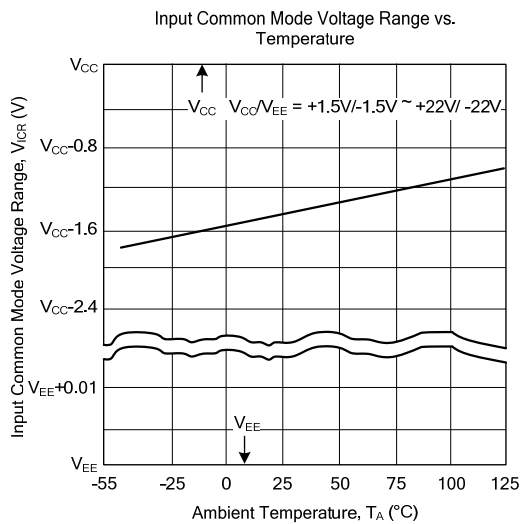
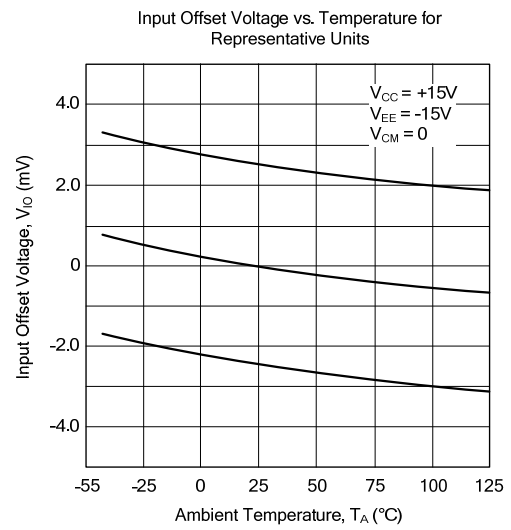
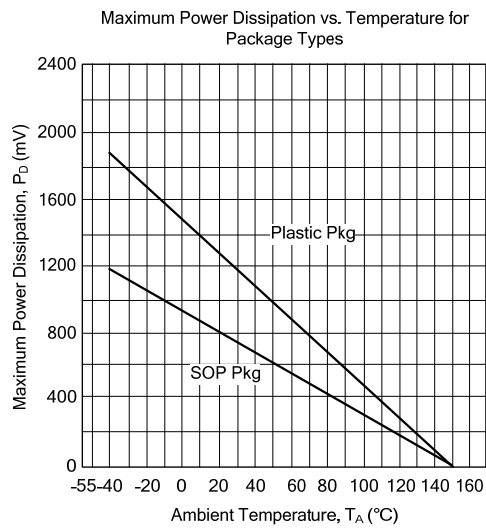

TYPICAL CHARACTERISTICS (Cont)

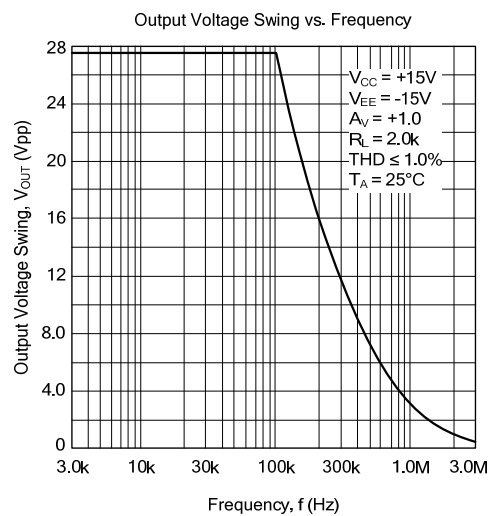
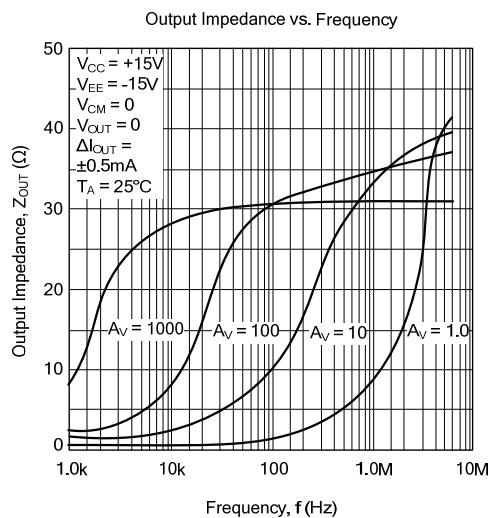
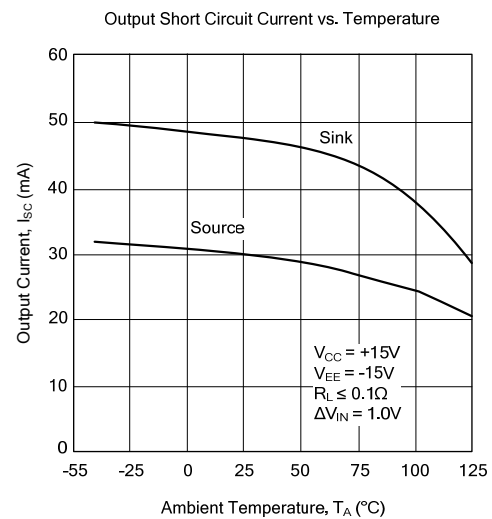
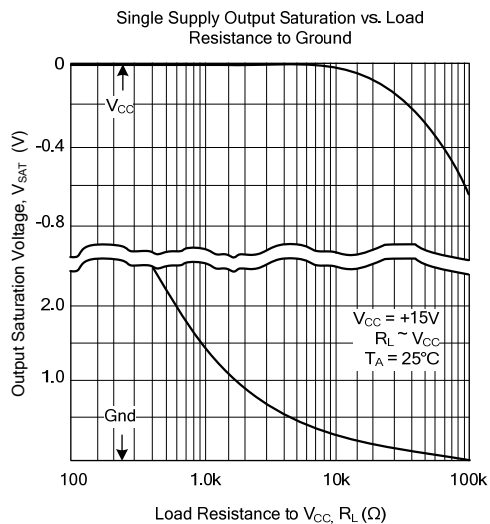
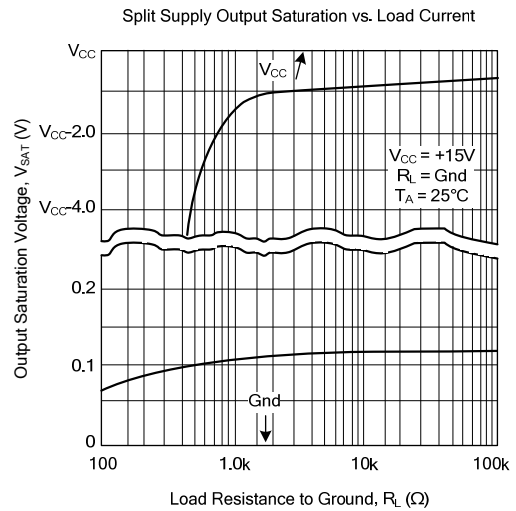
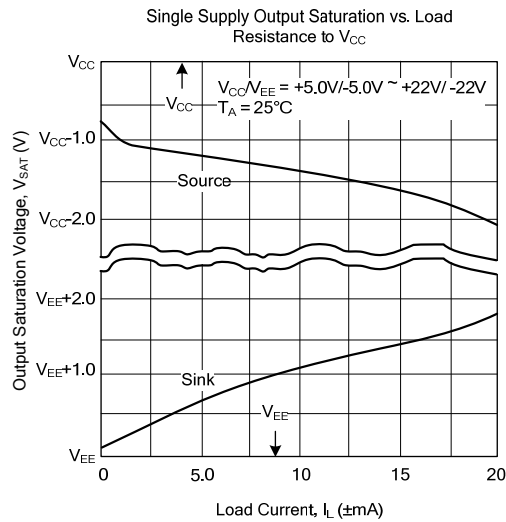

TYPICAL CHARACTERISTICS(Cont.)

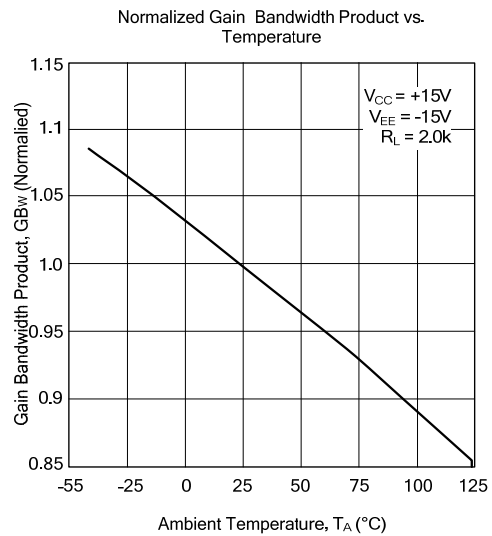
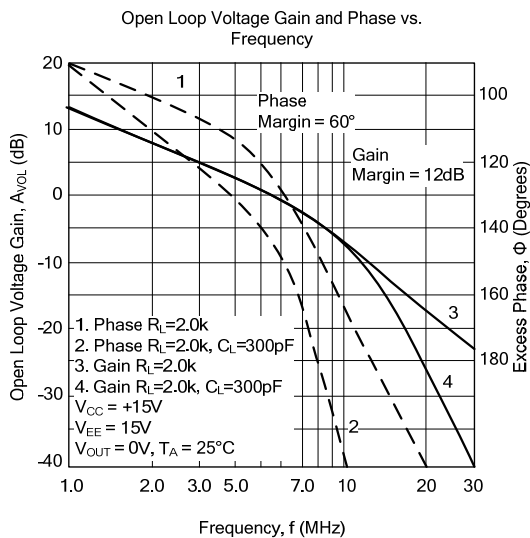
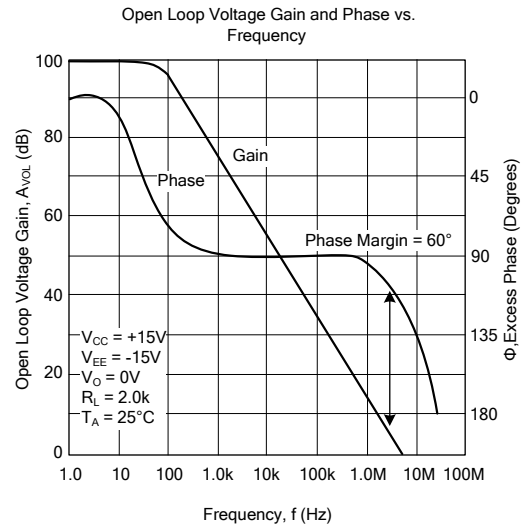
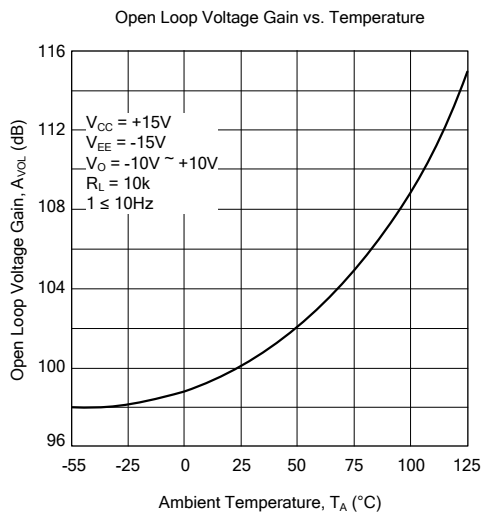
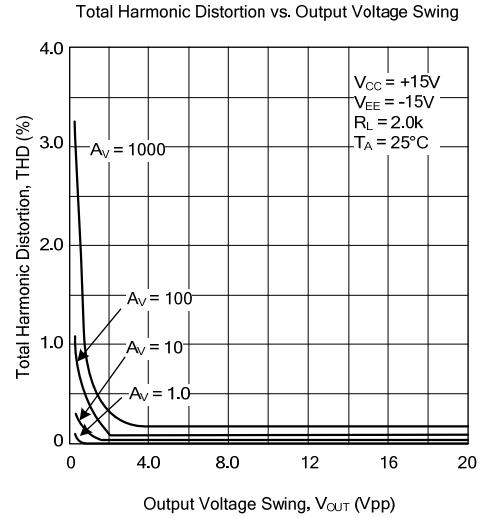
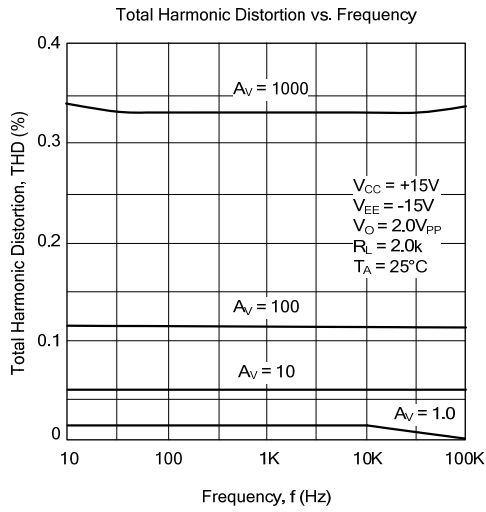

TYPICAL CHARACTERISTICS(Cont.)

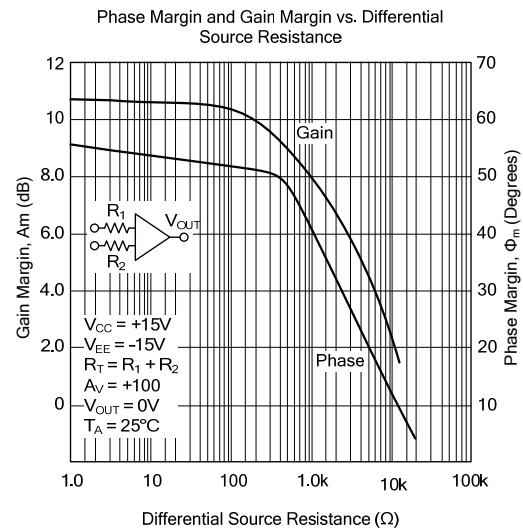
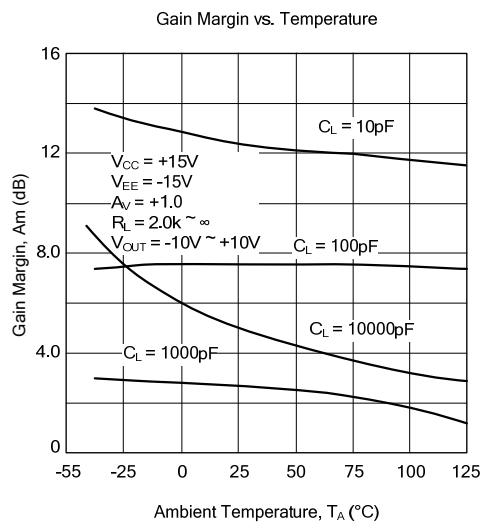
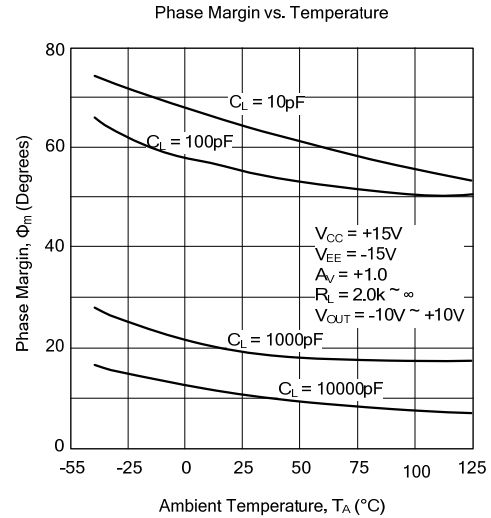
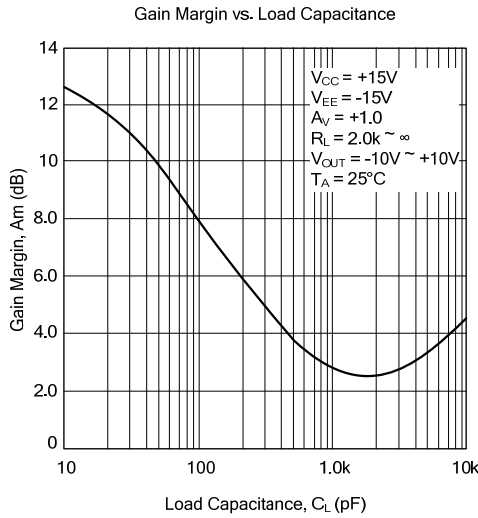
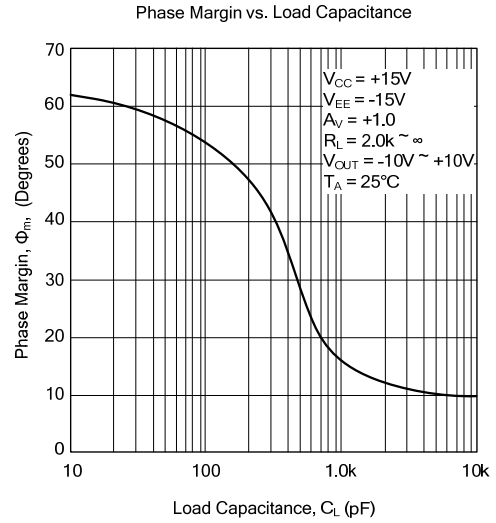
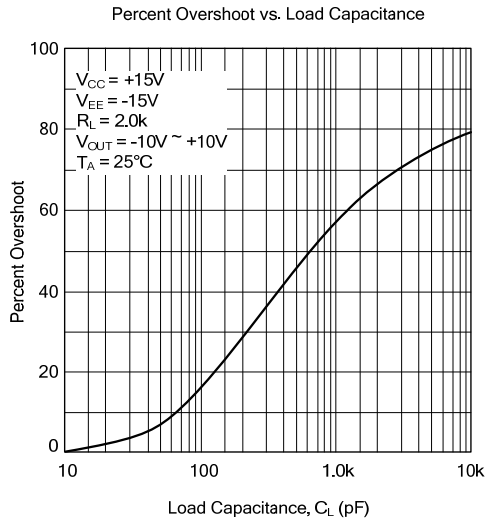

TYPICAL CHARACTERISTICS(Cont.)

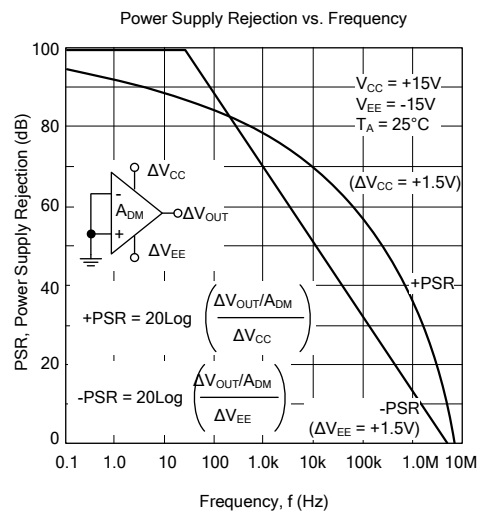
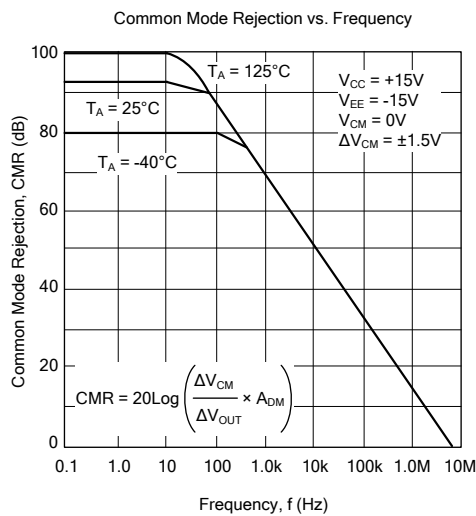
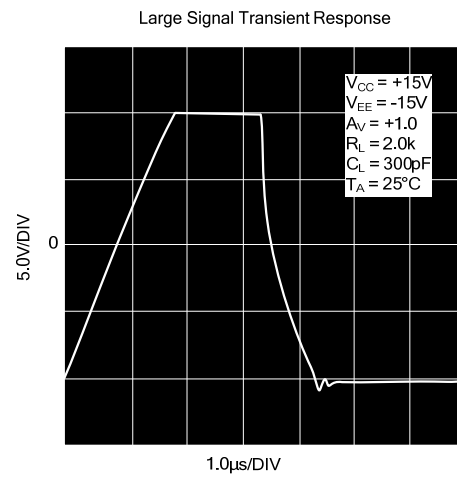
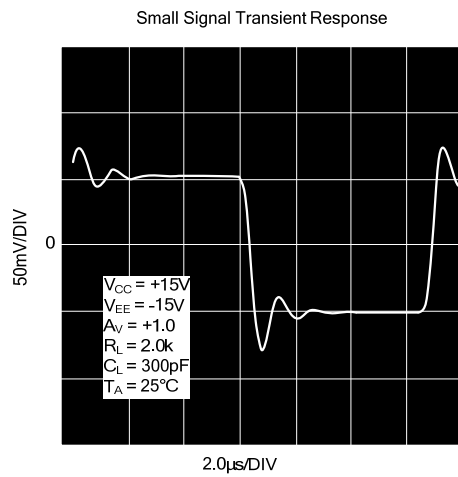
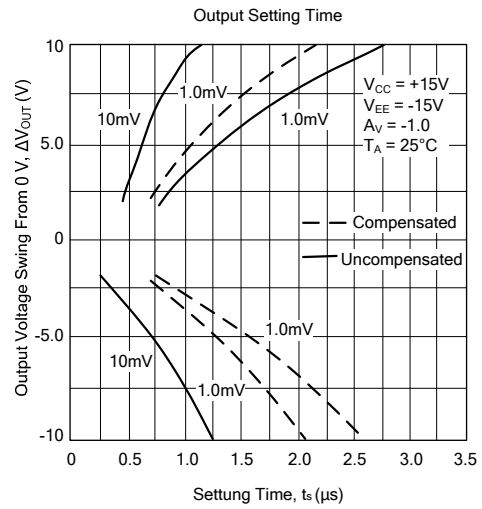
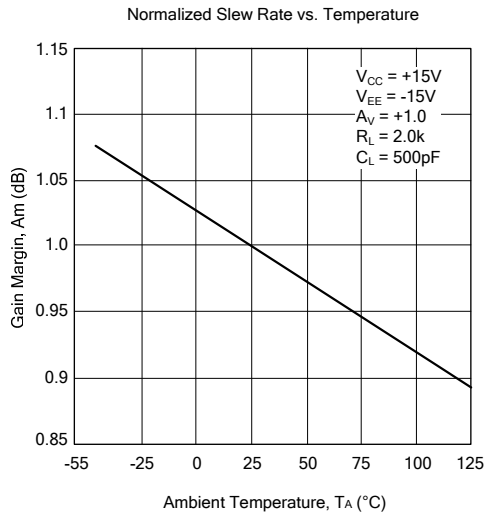

TYPICAL CHARACTERISTICS(Cont.)

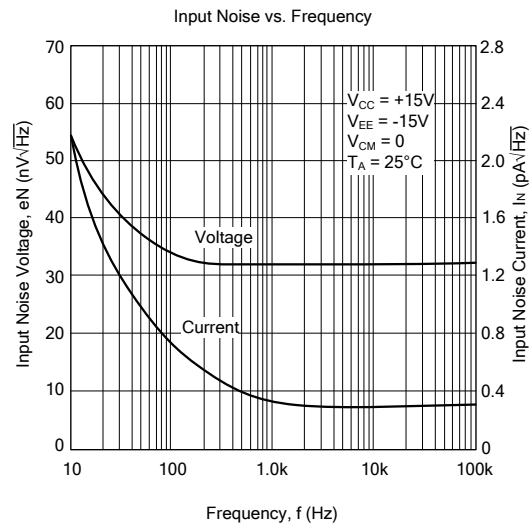
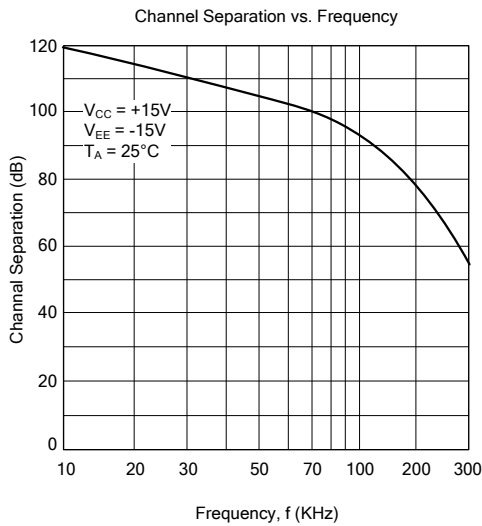
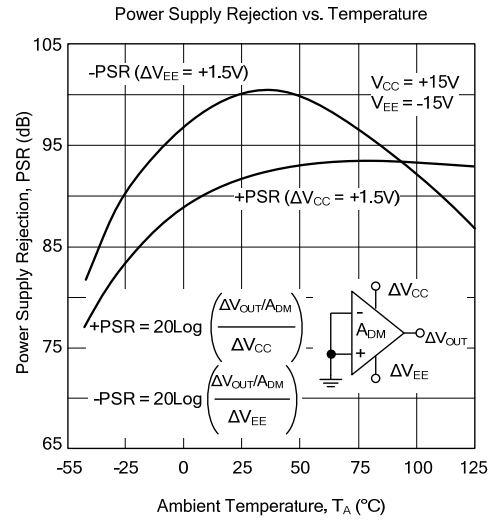
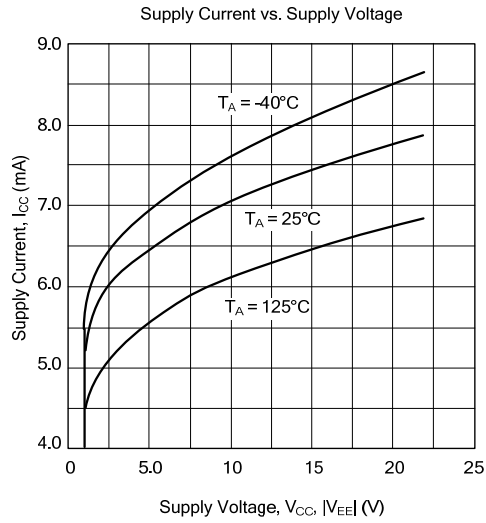

UTC assumes no responsibility for equipment failures that result from using products at values that exceed, even momentarily, rated values (such as maximum ratings, operating condition ranges, or other parameters) listed in products specifications of any and all UTC products described or contained herein. UTC products are not designed for use in life support appliances, devices or systems where malfunction of these products can be reasonably expected to result in personal injury. Reproduction in whole or in part is prohibited without the prior written consent of the copyright owner. The information presented in this document does not form part of any quotation or contract, is believed to be accurate and reliable and may be changed without notice.

X-ON Electronics

Largest Supplier of Electrical and Electronic Components

Click to view similar products for [High Speed Operational Amplifiers](#) category:

Click to view products by [Unisonic](#) manufacturer:

Other Similar products are found below :

[NJU7047RB1-TE2](#) [ADA4862-3YRZ-RL](#) [LT6301IFE](#) [ADA4895-2ARMZ-R7](#) [MAX4381EUB+](#) [OPA2677IDDAR](#) [LTC6401CUD-26#PBF](#)
[THS6042ID](#) [THS4221DBVR](#) [THS4081CD](#) [LTC6400IUD-20#PBF](#) [ADA4851-2YRMZ-RL](#) [THS4051CDR](#) [LT1223CN8#PBF](#)
[OPA2889IDGSR](#) [LT6202IS5#TRMPBF](#) [EL8302IUZ-T7](#) [LT1206CR#PBF](#) [LT1260CN#PBF](#) [LT6203IDD#PBF](#) [LT1810IMS8#PBF](#)
[TPH2502-SR](#) [OPA2132PAG4](#) [OPA2353UA/2K5](#) [OPA2691I-14D](#) [OPA4353UA/2K5](#) [OPA690IDRG4](#) [AD8000YCPZ-REEL7](#)
[AD8007AKSZ-REEL7](#) [AD8010ANZ](#) [AD8012ARMZ-REEL7](#) [AD8014ARTZ-REEL7](#) [AD8016AREZ](#) [AD8021ARMZ-REEL7](#)
[AD8022ARMZ-REEL7](#) [AD8024ARZ](#) [AD8028ARMZ](#) [AD8029AKSZ-REEL7](#) [AD8030ARJZ-REEL7](#) [AD8036ANZ](#) [AD8038AKSZ-REEL7](#)
[AD8039ARTZ-REEL7](#) [AD8040WARUZ-REEL7](#) [AD8041ANZ](#) [AD8044ANZ](#) [AD8051ARTZ-REEL7](#) [AD8055ANZ](#) [AD8056ANZ](#)
[AD8056ARMZ](#) [AD8057ARTZ-REEL7](#)