

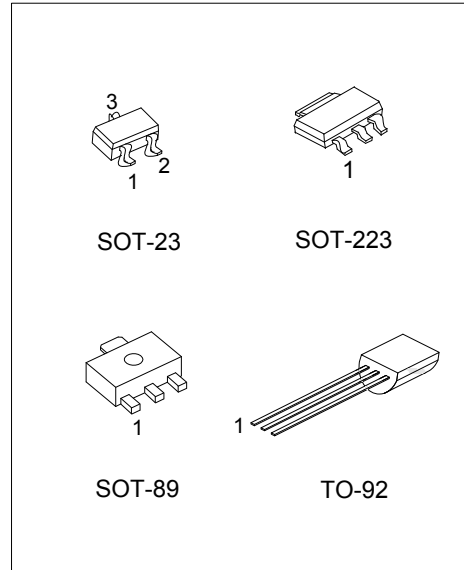

MCR100

SCR

**SENSITIVE GATE SILICON
CONTROLLED RECTIFIERS
REVERSE BLOCKING
THYRISTORS**



■ **DESCRIPTION**

PNPN devices designed for high volume, line-powered consumer applications such as relay and lamp drivers, small motor controls, gate drivers for larger thyristors, and sensing and detection circuits.

■ **FEATURES**

- * Sensitive gate allows triggering by micro controllers and other logic circuits
- * Blocking voltage to 600V
- * On-state current rating of 0.8A RMS at 80°C
- * High surge current capability – 10A
- * Minimum and maximum values of I_{GT} , V_{GT} and I_H specified for ease of design
- * Immunity to dV/dt – 20V/ μ sec minimum at 110°C
- * Glass-passivated surface for reliability and uniformity

■ **ORDERING INFORMATION**

Ordering Number		Package	Pin assignment			Packing
Lead Free	Halogen Free		1	2	3	
MCR100L-4-x-AA3-R	MCR100G-4-x-AA3-R	SOT-223	K	A	G	Tape Reel
MCR100L-4-x-AB3-R	MCR100G-4-x-AB3-R	SOT-89	G	A	K	Tape Reel
MCR100L-4-x-AE3-R	MCR100G-4-x-AE3-R	SOT-23	K	G	A	Tape Reel
MCR100L-4-x-T92-B	MCR100G-4-x-T92-B	TO-92	K	G	A	Tape Box
MCR100L-4-x-T92-K	MCR100G-4-x-T92-K	TO-92	K	G	A	Bulk
MCR100L-6-x-AA3-R	MCR100G-6-x-AA3-R	SOT-223	K	A	G	Tape Reel
MCR100L-6-x-AB3-R	MCR100G-6-x-AB3-R	SOT-89	G	A	K	Tape Reel
MCR100L-6-x-AE3-R	MCR100G-6-x-AE3-R	SOT-23	K	G	A	Tape Reel
MCR100L-6-x-T92-B	MCR100G-6-x-T92-B	TO-92	K	G	A	Tape Box
MCR100L-6-x-T92-K	MCR100G-6-x-T92-K	TO-92	K	G	A	Bulk
MCR100L-8-x-AA3-R	MCR100G-8-x-AA3-R	SOT-223	K	A	G	Tape Reel
MCR100L-8-x-AB3-R	MCR100G-8-x-AB3-R	SOT-89	G	A	K	Tape Reel
MCR100L-8-x-AE3-R	MCR100G-8-x-AE3-R	SOT-23	K	G	A	Tape Reel
MCR100L-8-x-T92-B	MCR100G-8-x-T92-B	TO-92	K	G	A	Tape Box
MCR100L-8-x-T92-K	MCR100G-8-x-T92-K	TO-92	K	G	A	Bulk

Note: Pin assignment: K: Cathode A: Anode G: Gate

<p>MCR100G-4-x-AA3-R</p> <p>(1) Packing Type (2) Package Type (3) Rank (4) Green Package</p>	<p>(1) B: Tape Box, K: Bulk, R: Tape Reel (2) AB3: SOT-89, AE3: SOT-23, T92: TO-92 (3) x: Refer to CLASSIFICATION OF I_{GT} (4) G: Halogen Free and Lead Free, L: Lead Free</p>
--	--

MARKING

Package	MCR100-4	MCR100-6	MCR100-8
SOT-223	<p>L: Lead Free G: Halogen Free Date Code</p>	<p>L: Lead Free G: Halogen Free Date Code</p>	<p>L: Lead Free G: Halogen Free Date Code</p>
SOT-89	<p>Date Code L: Lead Free G: Halogen Free</p>	<p>Date Code L: Lead Free G: Halogen Free</p>	<p>Date Code L: Lead Free G: Halogen Free</p>
SOT-23	<p>L: Lead Free G: Halogen Free</p>	<p>L: Lead Free G: Halogen Free</p>	<p>L: Lead Free G: Halogen Free</p>
TO-92	<p>UTC MCR100 -4 Date Code</p> <p>L: Lead Free G: Halogen Free Date Code</p>	<p>UTC MCR100 -6 Date Code</p> <p>L: Lead Free G: Halogen Free Date Code</p>	<p>UTC MCR100 -8 Date Code</p> <p>L: Lead Free G: Halogen Free Date Code</p>

■ ABSOLUTE MAXIMUM RATINGS

PARAMETER		SYMBOL	RATINGS	UNIT
Peak Repetitive Off-State Voltage(Note 1) ($T_J=-40 \sim 110^\circ\text{C}$, Sine Wave, 50 ~ 60Hz; Gate Open)	MCR100-4	$V_{\text{DRM}}, V_{\text{RRM}}$	200	V
	MCR100-6		400	V
	MCR100-8		600	V
On-State RMS Current ($T_c=80^\circ\text{C}$) 180°C Condition Angles		$I_{\text{T(RMS)}}$	0.8	A
Peak Non-Repetitive Surge Current (1/2 cycle, Sine Wave, 60Hz, $T_J=25^\circ\text{C}$)		I_{TSM}	10	A
Circuit Fusing Considerations ($t=8.3 \text{ ms}$)		I^2t	0.415	A^2s
Forward Peak Gate Power ($T_A=25^\circ\text{C}$, Pulse Width $\leq 1.0\mu\text{s}$)		P_{GM}	0.1	W
Forward Average Gate Power ($T_A=25^\circ\text{C}$, $t=8.3\text{ms}$)		$P_{\text{G(AV)}}$	0.01	W
Peak Gate Current – Forward ($T_A=25^\circ\text{C}$, Pulse Width $\leq 1.0\mu\text{s}$)		I_{GM}	1	A
Peak Gate Voltage – Reverse ($T_A=25^\circ\text{C}$, Pulse Width $\leq 1.0\mu\text{s}$)		V_{GRM}	5	V
Operating Junction Temperature Range (Rated V_{RRM} and V_{DRM})		T_J	-40 ~ +110	$^\circ\text{C}$
Storage Temperature Range		T_{STG}	-40 ~ +150	$^\circ\text{C}$

Note: Absolute maximum ratings are those values beyond which the device could be permanently damaged.
Absolute maximum ratings are stress ratings only and functional device operation is not implied.

■ THERMAL DATA

PARAMETER		SYMBOL	MAX	UNIT
Junction to Ambient	SOT-223	θ_{JA}	180	$^\circ\text{C/W}$
	SOT-23/SOT-89		400	$^\circ\text{C/W}$
	TO-92		200	$^\circ\text{C/W}$

■ ELECTRICAL CHARACTERISTICS ($T_J=25^\circ\text{C}$, unless otherwise stated)

PARAMETER	SYMBOL	TEST CONDITIONS	MIN	TYP	MAX	UNIT	
OFF CHARACTERISTICS							
Peak Forward or Reverse Blocking Current	$T_C=25^\circ\text{C}$ $T_C=110^\circ\text{C}$	$I_{\text{DRM}}, I_{\text{RRM}}$	$V_D=\text{Rated } V_{\text{DRM}} \text{ and } V_{\text{RRM}};$ $R_{\text{GK}}=1\text{k}\Omega$		10	μA	
					100	μA	
ON CHARACTERISTICS							
Peak Forward On-State Voltage (Note 2)	V_{TM}	$I_{\text{TM}}=1\text{A Peak @ } T_A=25^\circ\text{C}$			1.7	V	
Gate Trigger Current (Continuous DC) (Note3)	I_{GT}	$V_{\text{AK}}=7\text{Vdc}, R_L=100\Omega, T_C=25^\circ\text{C}$		40	200	μA	
Holding Current	$T_C=25^\circ\text{C}$ $T_C=-40^\circ\text{C}$	I_{H}	$V_{\text{AK}}=7\text{Vdc}$, initiating current=20mA		0.5	5	mA
					10	mA	
Latch Current	$T_C=25^\circ\text{C}$ $T_C=-40^\circ\text{C}$	I_{L}	$V_{\text{AK}}=7\text{V}, I_{\text{g}}=200\mu\text{A}$		0.6	10	mA
					15	mA	
Gate Trigger Voltage (continuous dc)	$T_C=25^\circ\text{C}$ $T_C=-40^\circ\text{C}$	V_{GT}	$V_{\text{AK}}=7\text{Vdc}, R_L=100\Omega$		0.62	0.8	V
					1.2	V	
DYNAMIC CHARACTERISTICS							
Critical Rate of Rise of Off-State Voltage	d_v/dt	$V_D=\text{Rated } V_{\text{DRM}}$, Exponential Waveform, $R_{\text{GK}}=1000\Omega$, $T_J=110^\circ\text{C}$	20	35		V/ μs	
Critical Rate of Rise of On-State Current	d_i/dt	$I_{\text{PK}}=20\text{A}; P_w=10\mu\text{sec};$ $d_i/dt=1\text{A}/\mu\text{sec}, I_{\text{gt}}=20\text{mA}$			50	A/ μs	

Notes: 1. V_{DRM} and V_{RRM} for all types can be applied on a continuous basis. Ratings apply for zero or negative gate voltage; however, positive gate voltage shall not be applied concurrent with negative potential on the anode. Blocking voltages shall not be tested with a constant current source such that the voltage ratings of the devices are exceeded.

2. Indicates Pulse Test Width $\leq 1.0\text{ms}$, duty cycle $\leq 1\%$.

3. Does not include RGK in measurement.

■ VOLTAGE CURRENT CHARACTERISTIC OF SCR

PARAMETER	SYMBOL
Peak Repetitive Off Stat Forward Voltage	V_{DRM}
Peak Forward Blocking Current	I_{DRM}
Peak Repetitive Off State Reverse Voltage	V_{RRM}
Peak Reverse Blocking Current	I_{RRM}
Peak On State Voltage	V_{TM}
Holding Current	I_H

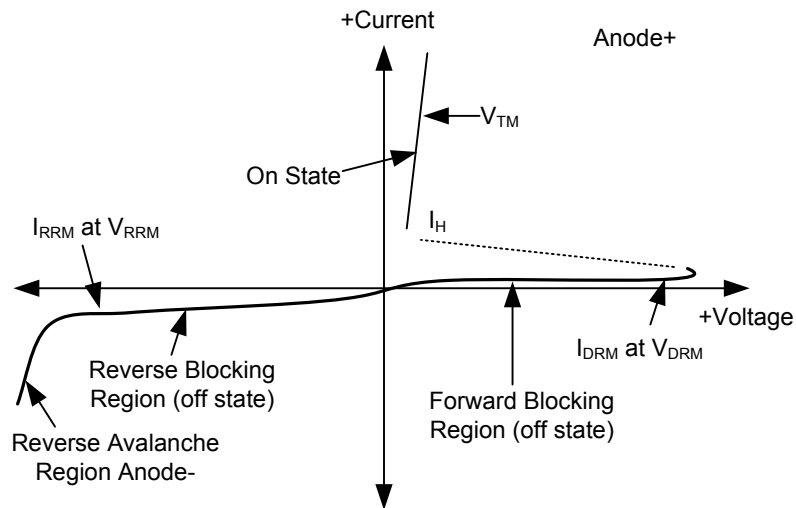

■ CLASSIFICATION OF I_{GT}

RANK	B	C	AA	AB	AC	AD
RANGE	48~105 μ A	95~200 μ A	8~16 μ A	14~21 μ A	19~25 μ A	23~52 μ A

■ TYPICAL CHARACTERISTICS

Typical Gate Trigger Current vs. Junction Temperature

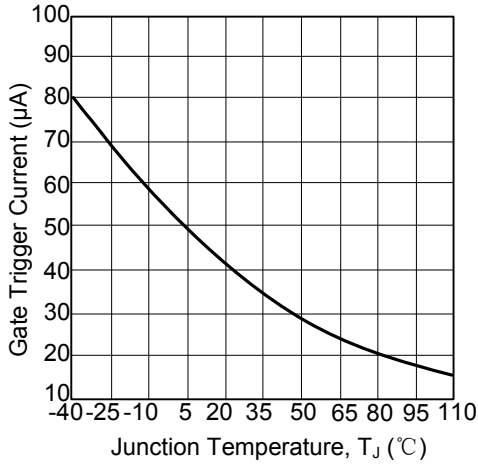

Typical Gate Trigger Voltage vs. Junction Temperature

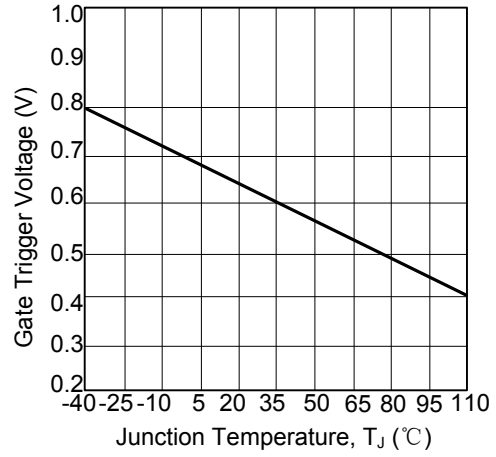

Typical Holding Current vs. Junction Temperature

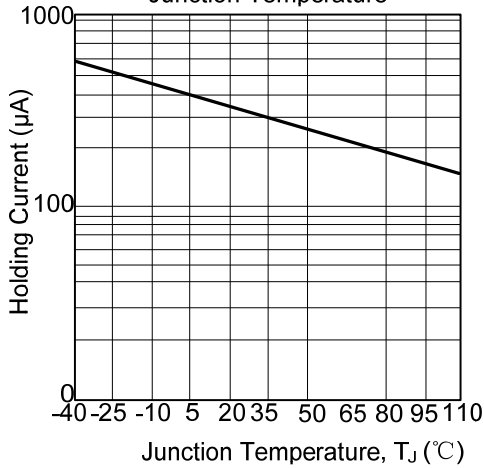

Typical Latching Current vs. Junction Temperature

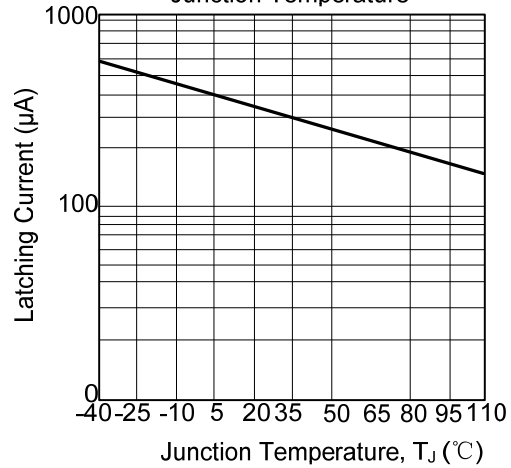

Typical RMS Current Derating

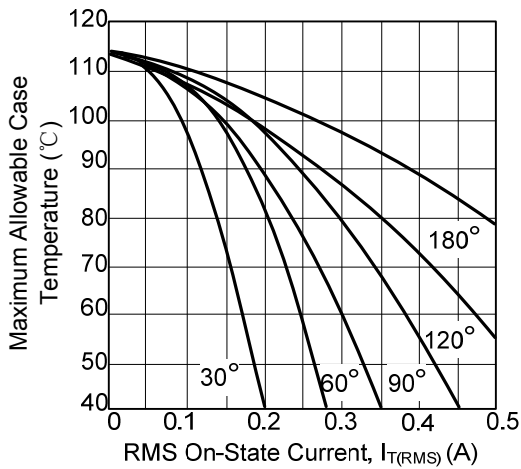

Typical On-State Characteristics

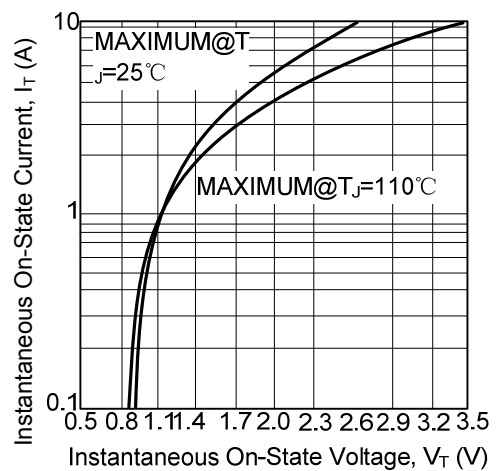

UTC assumes no responsibility for equipment failures that result from using products at values that exceed, even momentarily, rated values (such as maximum ratings, operating condition ranges, or other parameters) listed in products specifications of any and all UTC products described or contained herein. UTC products are not designed for use in life support appliances, devices or systems where malfunction of these products can be reasonably expected to result in personal injury. Reproduction in whole or in part is prohibited without the prior written consent of the copyright owner. UTC reserves the right to make changes to information published in this document, including without limitation specifications and product descriptions, at any time and without notice. This document supersedes and replaces all information supplied prior to the publication hereof.

X-ON Electronics

Largest Supplier of Electrical and Electronic Components

Click to view similar products for [Triacs](#) category:

Click to view products by [Unisonic](#) manufacturer:

Other Similar products are found below :

[T2035H-6G](#) [BT137-600-0Q](#) [Z0409MF0AA2](#) [Z0109NA 2AL2](#) [ACST1635T-8FP](#) [BCR20RM-30LA#B00](#) [CMA60MT1600NHR](#) [NTE5611](#)
[NTE5612](#) [NTE5613](#) [NTE5621](#) [NTE5623](#) [NTE5629](#) [NTE5638-08](#) [NTE5688](#) [NTE5689](#) [NTE5690](#) [T1235T-8I](#) [BTA312-600CT.127](#) [T1210T-](#)
[8G-TR](#) [Z0109NN0,135](#) [T2535T-8I](#) [T2535T-8T](#) [TN4050-12WL](#) [MAC4DLM-1G](#) [BT137-600E,127](#) [BT137X-600D](#) [BT148W-600R,115](#)
[BT258-500R,127](#) [BTA08-800BW3G](#) [BTA140-800,127](#) [BTA30-600CW3G](#) [BTA30-600CW3G](#) [BTB08-800BW3G](#) [BTB16-600CW3G](#)
[BTB16-600CW3G](#) [Z0410MF0AA2](#) [Z0109MN,135](#) [T825T-6I](#) [T1635T-6I](#) [T1220T-6I](#) [NTE5638](#) [TYN612MRG](#) [TYN1225RG](#) [TPDV840RG](#)
[ACST1235-8FP](#) [ACS302-6T3-TR](#) [BT134-600D,127](#) [BT134-600G,127](#) [BT136X-600E,127](#)