



TL072

LINEAR INTEGRATED CIRCUIT

LOW NOISE DUAL J-FET OPERATIONAL AMPLIFIER

■ DESCRIPTION

The UTC **TL072** is a high speed J-FET input quad operational amplifier. It incorporates well matched, high voltage J-FET and bipolar transistors in a monolithic integrated circuit. The device features high slew rates, low input bias and offset current, and low offset voltage temperature coefficient.

■ FEATURES

- * Low power consumption
- * Wide common-mode (up to V_{CC+}) and differential voltage range
- * Low input bias and offset current
- * Low noise $e_n = 15nV / \sqrt{Hz}$ (typ.)
- * Output short-circuit protection
- * High input impedance J-FET input stage
- * Low harmonic distortion:0.01% (typ.)
- * Internal frequency compensation
- * Latch up free operation
- * High slewrate:10V/ μs (typ.)

■ ORDERING INFORMATION

| Ordering Number | | Package | Packing |
|-----------------|--------------|---------|-----------|
| Lead Free | Halogen Free | | |
| TL072L-D08-T | TL072G-D08-T | DIP-8 | Tube |
| TL072L-S08-R | TL072G-S08-R | SOP-8 | Tape Reel |
| TL072L-P08-R | TL072G-P08-R | TSSOP-8 | Tape Reel |

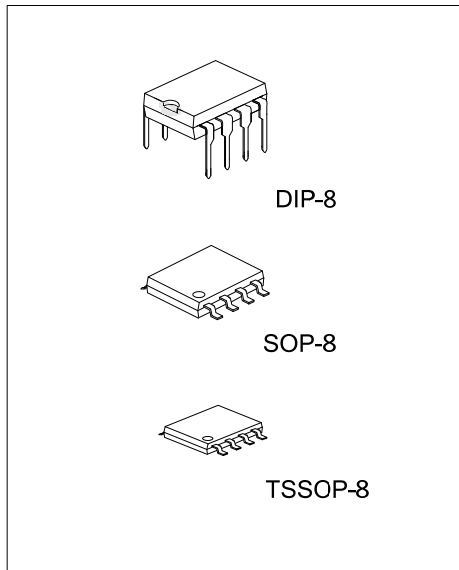

| | |
|---|---|
| <p>TL072G-D08-T</p> <p>(1)Packing Type (2)Package Type (3)Green Package</p> | <p>(1) T: Tube, R: Tape Reel (2) D08: DIP-8, S08: SOP-8, P08: TSSOP-8 (3) G: Halogen Free and Lead Free, L: Lead Free</p> |
|---|---|

■ MARKING

| DIP-8 | SOP-8 | TSSOP-8 |
|--|--|--|
| <p>UTC □□□□ TL072 □</p> <p>8 7 6 5 → Date Code L: Lead Free G: Halogen Free □ □ → Lot Code 1 2 3 4</p> | <p>UTC □□□□ TL072 □</p> <p>8 7 6 5 → Date Code L: Lead Free G: Halogen Free □ □ → Lot Code 1 2 3 4</p> | <p>UTC □□□□ TL072 □</p> <p>8 7 → Date Code L: Lead Free G: Halogen Free □ □ → Lot Code 1 2 3 4 5</p> |

■ PIN CONFIGURATION

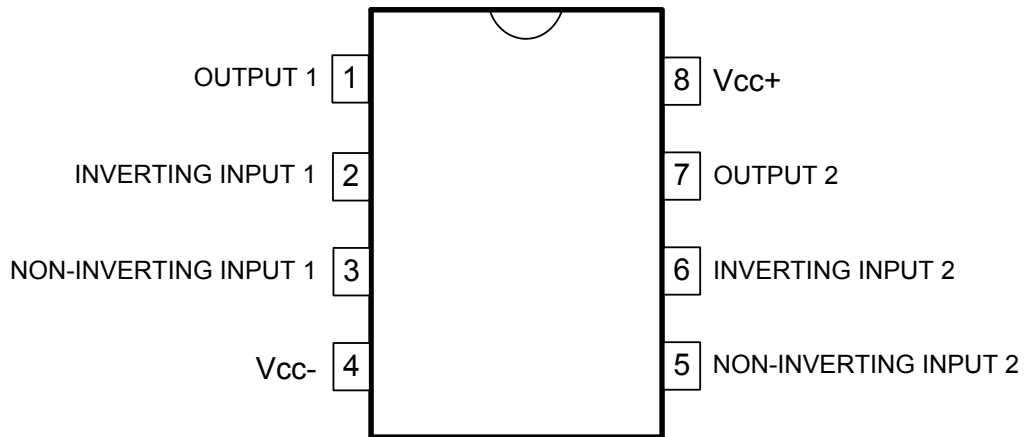

■ BLOCK DIAGRAM

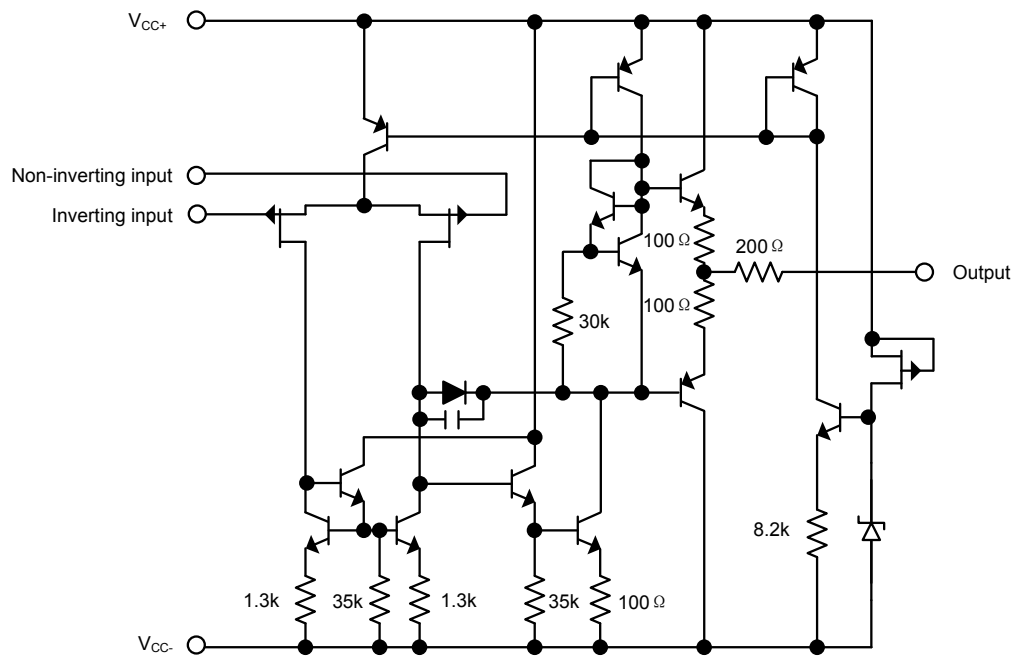

■ ABSOLUTE MAXIMUM RATINGS (T_A=25°C, unless otherwise specified)

| PARAMETER | | SYMBOL | RATINGS | UNIT |
|--|---------|----------------------|---------------------|------|
| Supply Voltage (Note 2) | | V _{CC} | ±18 | V |
| Input Voltage (Note 3) | | V _{IN} | ±15 | V |
| Differential Input Voltage (Note 4) | | V _{I(DIFF)} | ±30 | V |
| Power Dissipation | DIP-8 | P _D | 625 | mW |
| | SOP-8 | | 440 | mW |
| | TSSOP-8 | | 360 | mW |
| Output Short-Circuit Duration (Note 5) | | | Infinite | |
| Operating Temperature | | T _{OPR} | -40 ~ +125 (Note 6) | °C |
| Storage Temperature | | T _{STG} | -65 ~ +150 | °C |

- Notes: 1. Absolute maximum ratings are those values beyond which the device could be permanently damaged. Absolute maximum ratings are stress ratings only and functional device operation is not implied.
2. All voltage values, except differential voltage, are with respect to the zero reference level (ground) of the supply voltages where the zero reference level is the midpoint between V_{CC-} and V_{CC+}.
3. The magnitude of the input voltage must never exceed the magnitude of the supply voltage or 15 volts, whichever is less.
4. Differential voltages are at the non-inverting input terminal with respect to the inverting input terminal.
5. The output may be shorted to ground or to either supply. Temperature and/or supply voltages must be limited to ensure that the dissipation rating is not exceeded.
6. It is guarantee by design, not 100% be tested.

■ ELECTRICAL CHARACTERISTICS ($V_{CC}=\pm 15V$, $T_A=25^\circ C$, unless otherwise specified)

| PARAMETER | SYMBOL | CONDITIONS | | MIN | TYP | MAX | UNIT |
|---|---------------------|---|---------------------------------|----------|------------|-----|------------------------|
| Input Offset Voltage | $V_{I(OFF)}$ | $R_S=50\Omega$ | $T_A=25^\circ C$ | | 3 | 10 | mV |
| | | | $T_{MIN} \leq T_A \leq T_{MAX}$ | | | | 13 |
| Temperature Coefficient of Input Offset Voltage | $\Delta V_{I(OFF)}$ | $R_S=50\Omega$ | | | 10 | | $\mu V/^\circ C$ |
| Input Offset Current (Note) | $I_{I(OFF)}$ | | $T_A=25^\circ C$ | | 5 | 100 | pA |
| | | | $T_{MIN} \leq T_A \leq T_{MAX}$ | | | | 10 |
| Input Bias Current (Note) | $I_{I(BIAS)}$ | | $T_A=25^\circ C$ | | 20 | 200 | pA |
| | | | $T_{MIN} \leq T_A \leq T_{MAX}$ | | | | 20 |
| Input Common Mode Voltage | $V_{I(CM)}$ | | | ± 11 | -12~+15 | | V |
| Output Voltage Swing | $V_{O(SW)}$ | $R_L=2k\Omega$ | $T_A=25^\circ C$ | ± 10 | ± 12 | | V |
| | | $R_L=10k\Omega$ | | ± 12 | ± 13.5 | | V |
| | | $R_L=2k\Omega$ | $T_{MIN} \leq T_A \leq T_{MAX}$ | ± 10 | | | V |
| | | $R_L=10k\Omega$ | | ± 12 | | | V |
| Large Signal Voltage Gain | A _{vd} | $R_L=10k\Omega$, $V_{OUT}=\pm 10V$ | $T_A=25^\circ C$ | 25 | 200 | | V/mV |
| | | | $T_{MIN} \leq T_A \leq T_{MAX}$ | 15 | | | V/mV |
| Gain Bandwidth Product | GB _W | $T_A=25^\circ C$, $R_L=10k\Omega$, $C_L=100pF$ | | 2.5 | 4 | | MHz |
| Input Resistance | R_{IN} | | | | 10^{12} | | Ω |
| Common Mode Rejection Ratio | CMR | $R_S=50\Omega$ | $T_A=25^\circ C$ | 70 | 86 | | dB |
| | | | $T_{MIN} \leq T_A \leq T_{MAX}$ | 70 | | | dB |
| Supply Voltage Rejection Ratio | SVR | $R_S=50\Omega$ | $T_A=25^\circ C$ | 70 | 86 | | dB |
| | | | $T_{MIN} \leq T_A \leq T_{MAX}$ | 70 | | | dB |
| Supply Current | I_{CC} | No load | $T_A=25^\circ C$ | | 1.4 | 2.5 | mA |
| | | | $T_{MIN} \leq T_A \leq T_{MAX}$ | | | | 2.5 |
| Channel Separation | V01/V02 | $G_V=100$ | | | 120 | | dB |
| Output Short-circuit Current | I_{OS} | | $T_A=25^\circ C$ | 10 | 40 | 60 | mA |
| | | | $T_{MIN} \leq T_A \leq T_{MAX}$ | 10 | | 60 | mA |
| Slew Rate | SR | $V_{IN}=10V$, $R_L=2k\Omega$, $C_L=100pF$, unity gain | | 6 | 10 | | V/ μs |
| Rise Time | t_R | $V_{IN}=20mV$, $R_L=2k\Omega$, $C_L=100pF$, unity gain | | | 0.1 | | μs |
| Overshoot Factor | K _{ov} | $V_{IN}=20mV$, $R_L=2k\Omega$, $C_L=100pF$, unity gain | | | 10 | | % |
| Total Harmonic Distortion | THD | $G_V=20dB$, $f=1kHz$, $R_L=2k\Omega$, $C_L=100pF$, $V_{OUT}=2V_{pp}$ | | | 0.01 | | % |
| Phase Margin | ϕ_m | | | | 45 | | Degrees |
| Equivalent Input Noise Voltage | e _N | $R_S=100\Omega$, $f=1KHz$ | | | 15 | | $\frac{nV}{\sqrt{Hz}}$ |

Note: The Input bias currents are junction leakage currents, which approximately double for every 10 °C increase in the junction temperature.

■ PARAMETER MEASUREMENT INFORMATION

Figure 1. Voltage Follower

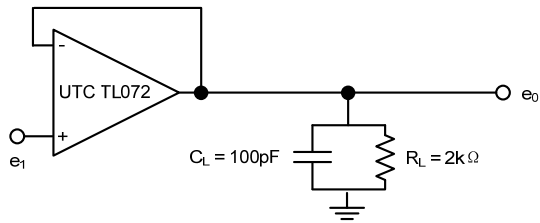
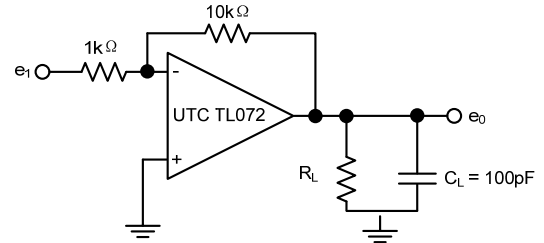
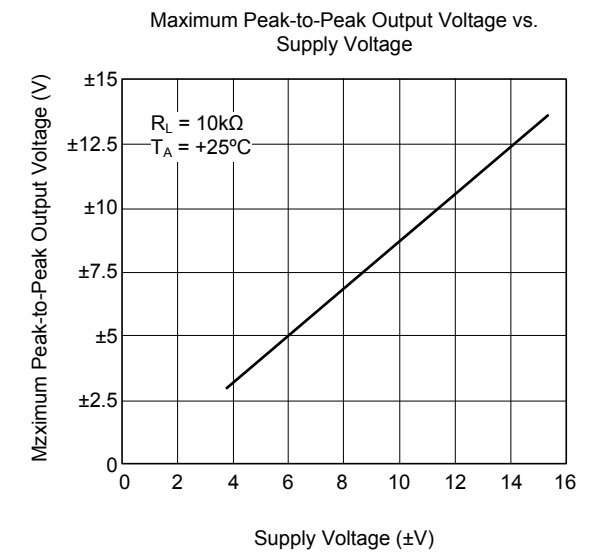
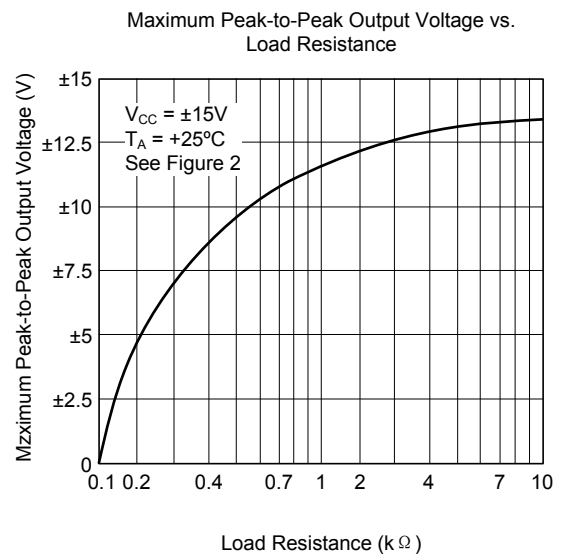
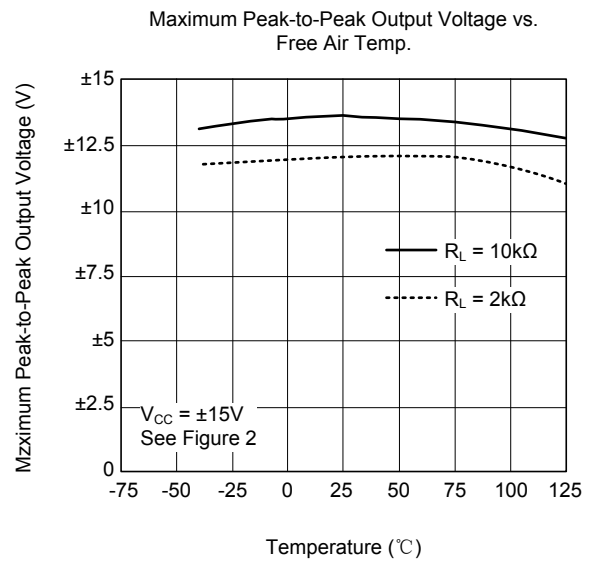
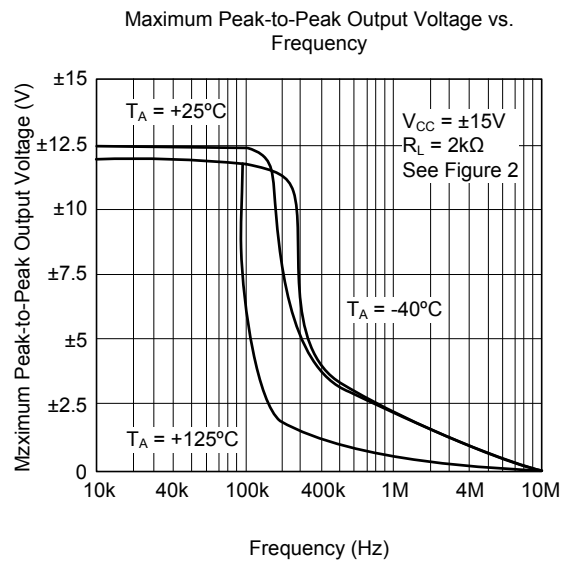
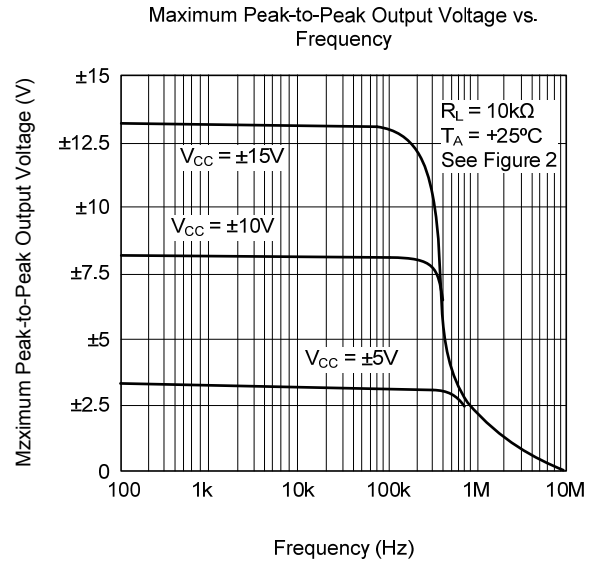
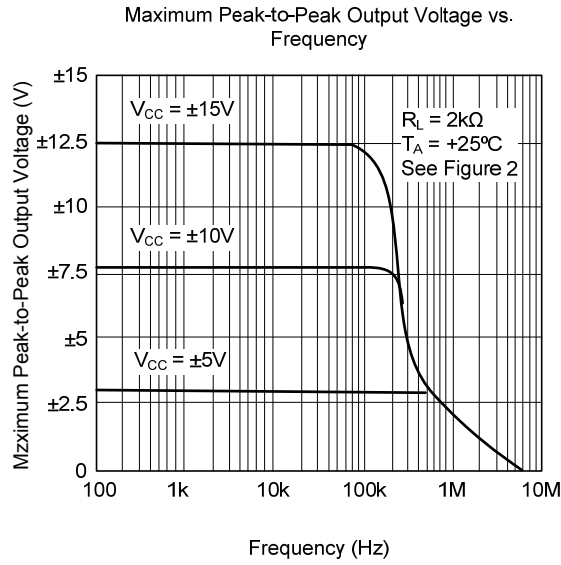

Figure 2. Gain-of-10 Inverting Amplifier



■ TYPICAL CHARACTERISTICS



■ TYPICAL CHARACTERISTICS (Cont.)

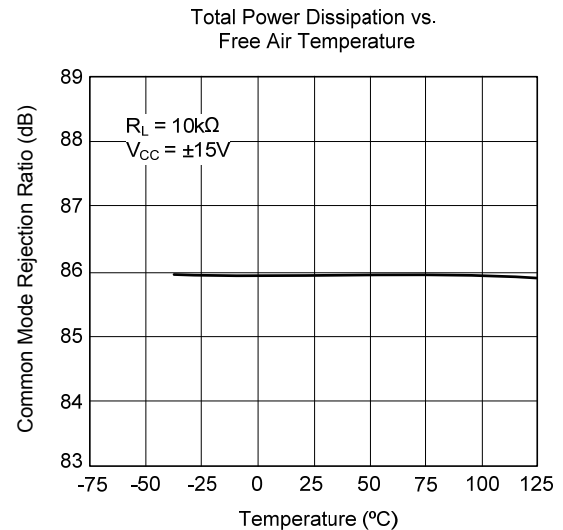
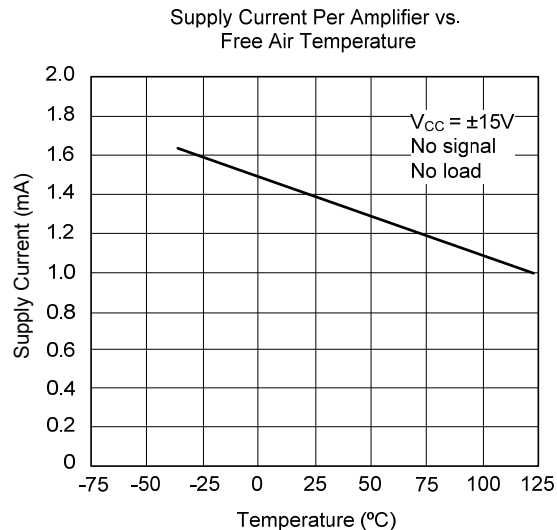
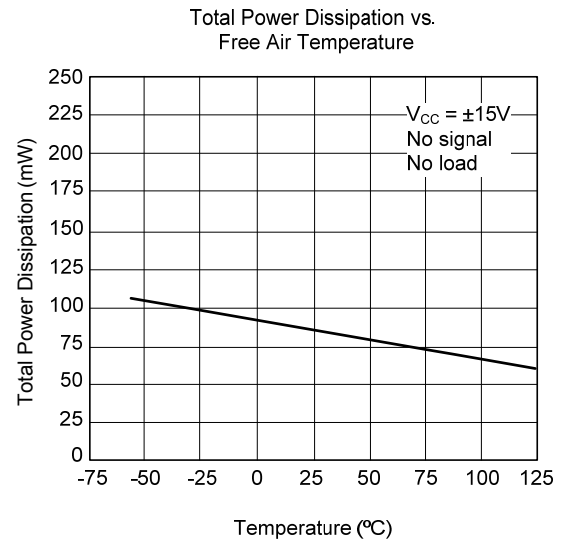
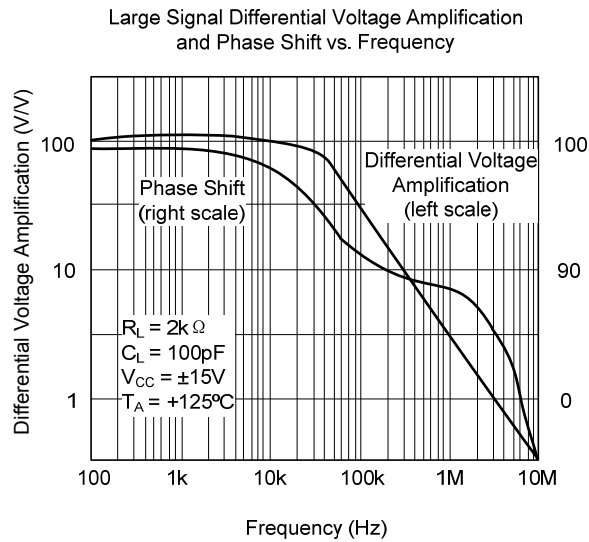
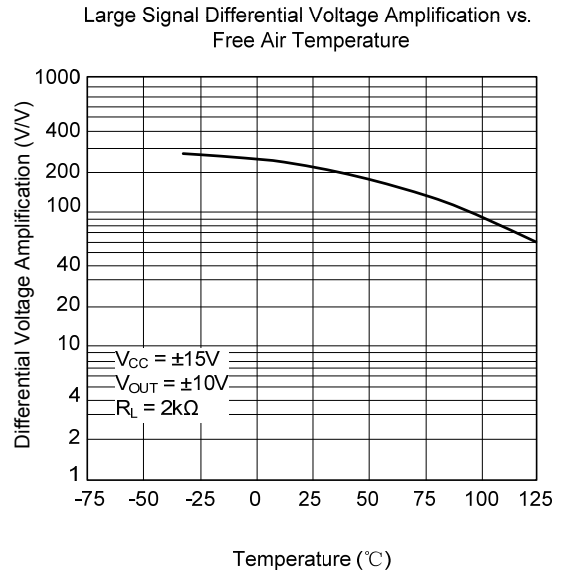
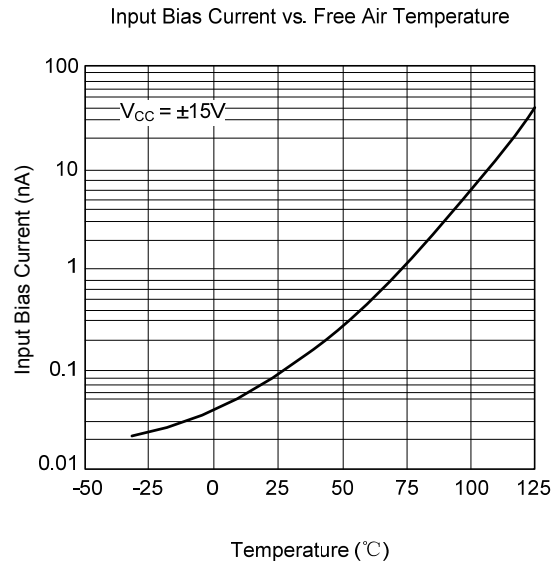

■ TYPICAL CHARACTERISTICS (Cont.)

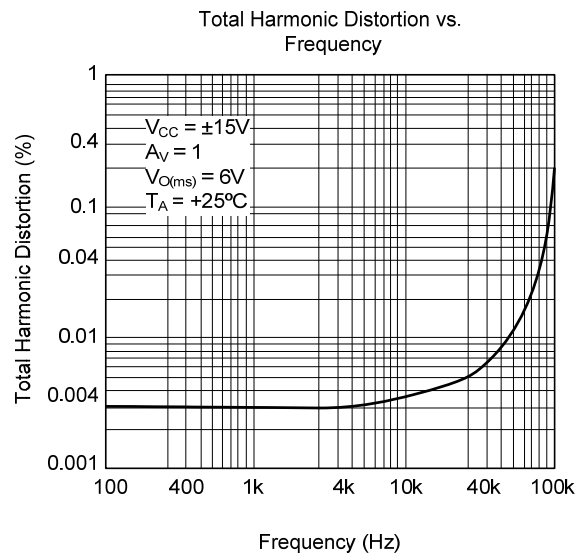
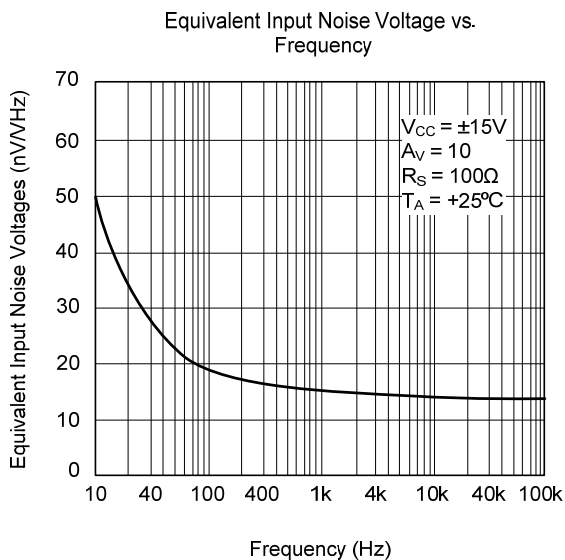
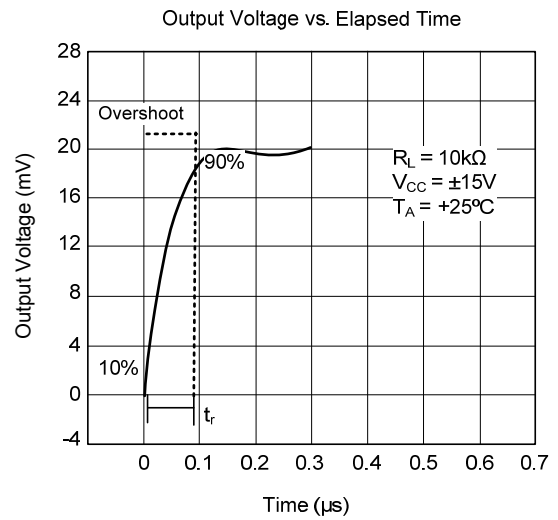
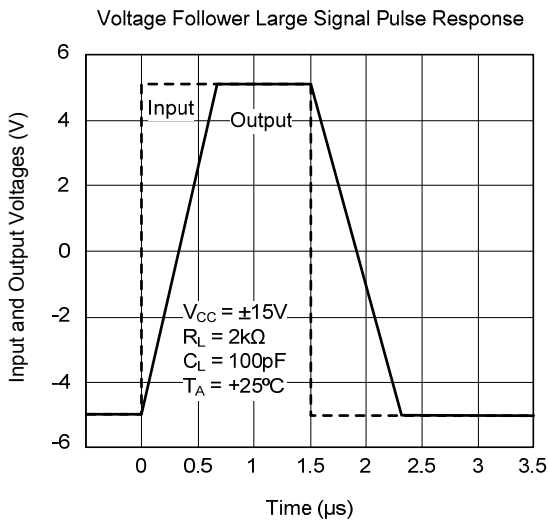

UTC assumes no responsibility for equipment failures that result from using products at values that exceed, even momentarily, rated values (such as maximum ratings, operating condition ranges, or other parameters) listed in products specifications of any and all UTC products described or contained herein. UTC products are not designed for use in life support appliances, devices or systems where malfunction of these products can be reasonably expected to result in personal injury. Reproduction in whole or in part is prohibited without the prior written consent of the copyright owner. UTC reserves the right to make changes to information published in this document, including without limitation specifications and product descriptions, at any time and without notice. This document supersedes and replaces all information supplied prior to the publication hereof.

X-ON Electronics

Largest Supplier of Electrical and Electronic Components

Click to view similar products for [Operational Amplifiers - Op Amps](#) category:

Click to view products by [Unisonic](#) manufacturer:

Other Similar products are found below :

[430227FB](#) [UPC451G2-A](#) [UPC824G2-A](#) [LT1678IS8](#) [UPC258G2-A](#) [NCV33202DMR2G](#) [NJM324E](#) [M38510/13101BPA](#) [NTE925](#)
[AZV358MTR-G1](#) [AP4310AUMTR-AG1](#) [AZV358MMTR-G1](#) [SCY33178DR2G](#) [NCV5652MUTWG](#) [NCV20034DR2G](#) [NTE778S](#) [NTE871](#)
[NTE937](#) [MCP6V16UT-E/OT](#) [SCY6358ADR2G](#) [UPC4570G2-E1-A](#) [NCS20282FCTTAG](#) [UPC834G2-E1-A](#) [UPC1458G2-E2-A](#) [UPC813G2-](#)
[E2-A](#) [UPC458G2-E1-A](#) [UPC824G2-E2-A](#) [UPC4574G2-E2-A](#) [UPC4558G2-E2-A](#) [UPC4560G2-E1-A](#) [UPC258G2-E1-A](#) [UPC4742GR-9LG-](#)
[E1-A](#) [UPC4742G2-E1-A](#) [UPC832G2-E2-A](#) [UPC842G2-E1-A](#) [UPC802G2-E1-A](#) [UPC4741G2-E2-A](#) [UPC4572G2-E2-A](#) [UPC844GR-9LG-](#)
[E2-A](#) [UPC259G2-E1-A](#) [UPC4741G2-E1-A](#) [UPC4558G2-E1-A](#) [UPC1251GR-9LG-E1-A](#) [UPC4744G2-E1-A](#) [UPC4092G2-E1-A](#)
[UPC4574G2-E1-A](#) [UPC4062G2-E2-A](#) [UPC451G2-E2-A](#) [UPC832G2-E1-A](#) [UPC844GR-9LG-E1-A](#)