



U74AHC1G08

CMOS IC

2-INPUT AND GATE

■ **DESCRIPTION**

The UTC **U74AHC1G08** is a high-speed si-gate CMOS device which provides the 2-input AND function.

■ **FEATURES**

- * Operation Voltage Range: 2~5.5V
- * Low Power Current: $I_{CC}=10\mu A(\text{Max})$
- * High speed: $t_{PD}=4.3\text{ns}(\text{Typ}) @ V_{CC} =5V$

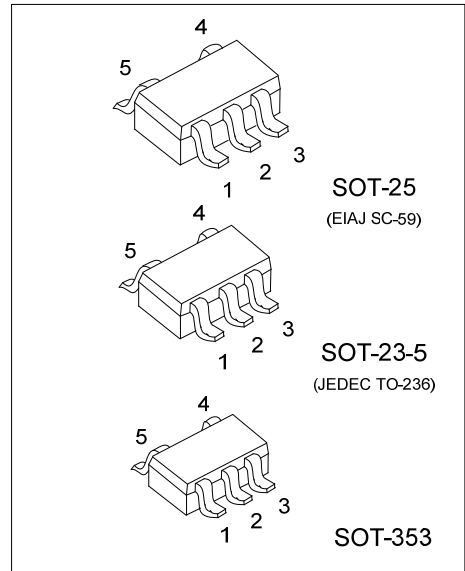

■ **ORDERING INFORMATION**

Ordering Number		Package	Packing
Lead Free	Halogen Free		
U74AHC1G08L-AE5-R	U74AHC1G08G-AE5-R	SOT-23-5	Tape Reel
U74AHC1G08L-AF5-R	U74AHC1G08G-AF5-R	SOT-25	Tape Reel
U74AHC1G08L-AL5-R	U74AHC1G08G-AL5-R	SOT-353	Tape Reel

<p>U74AHC1G08G-AE5-R</p> <p>(1)Packing Type (2)Package Type (3)Green Package</p>	<p>(1) R: Tape Reel (2) AE5: SOT-23-5, AF5: SOT-25, AL5: SOT-353 (3) G: Halogen Free and Lead Free, L: Lead Free</p>
--	--

■ **MARKING**

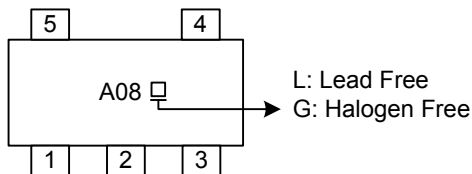

■ PIN CONFIGURATION

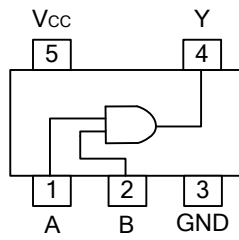

■ FUNCTION TABLE (each gate)

INPUTS		OUTPUT
A	B	Y
L	L	L
L	H	L
H	L	L
H	H	H

■ LOGIC DIAGRAM (positive logic)

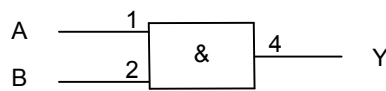
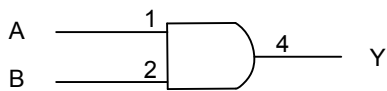

IEC logic symbol

■ ABSOLUTE MAXIMUM RATINGS (T_A =25°C, unless otherwise specified)

PARAMETER	SYMBOL	RATINGS	UNIT
Supply Voltage	V _{CC}	-0.5~7	V
Input Voltage	V _{IN}	-0.5~7	V
Output Voltage	V _{OUT}	-0.5~V _{CC} +0.5	V
Input Clamp Current	I _{IK}	-20	mA
Output Clamp Current	I _{OK}	±20	mA
Output Current	I _{OUT}	±25	mA
V _{CC} or GND Current	I _{CC}	±50	mA
Power Dissipation	P _D	250	mW
Storage Temperature	T _{STG}	-65 ~ +150	°C

Note: Absolute maximum ratings are those values beyond which the device could be permanently damaged. Absolute maximum ratings are stress ratings only and functional device operation is not implied.

■ RECOMMENDED OPERATING CONDITIONS

PARAMETER	SYMBOL	CONDITIONS	MIN	TYP	MAX	UNIT
Supply Voltage	V _{CC}		2		5.5	V
Input Voltage	V _{IN}		0		5.5	V
Output Voltage	V _{OUT}		0		V _{CC}	V
Input Transition Rise or Fall Times	t _R , t _F	V _{CC} =3.3V±0.3V			100	ns/V
		V _{CC} =5.0V±0.5V			20	
Operating Temperature	T _{OPR}		-40		125	°C

■ STATIC CHARACTERISTICS

PARAMETER	SYMBOL	TEST CONDITIONS	MIN	TYP	MAX	UNIT
High-Level Input Voltage	V _{IH}	V _{CC} =2.0V	1.5			V
		V _{CC} =3.0V	2.1			V
		V _{CC} =5.5V	3.85			V
Low-Level Input Voltage	V _{IL}	V _{CC} =2.0V			0.5	V
		V _{CC} =3.0V			0.9	V
		V _{CC} =5.5V			1.65	V
High-Level Output Voltage	V _{OH}	V _{CC} =2.0V, I _{OH} =-50μA	1.9	2.0		V
		V _{CC} =3.0V, I _{OH} =-50μA	2.9	3.0		V
		V _{CC} =4.5V, I _{OH} =-50μA	4.4	4.5		V
		V _{CC} =3.0V, I _{OH} =-4mA	2.58			V
		V _{CC} =4.5V, I _{OH} =-8mA	3.94			V
Low-Level Output Voltage	V _{OL}	V _{CC} =2.0V, I _{OL} =50μA			0.1	V
		V _{CC} =3.0V, I _{OL} =50μA			0.1	V
		V _{CC} =4.5V, I _{OL} =50μA			0.1	V
		V _{CC} =3.0V, I _{OL} =4mA			0.36	V
		V _{CC} =4.5V, I _{OL} =8mA			0.36	V
Input Leakage Current	I _{I(LEAK)}	V _{CC} =0~5.5V, V _{IN} =V _{CC} or GND			±0.1	μA
Quiescent Supply Current	I _Q	V _{CC} =5.5V, V _{IN} =V _{CC} or GND, I _{OUT} =0			1	μA
Input Capacitance	C _{IN}	V _{CC} =5V, V _{IN} =V _{CC} or GND		4	10	pF

■ DYNAMIC CHARACTERISTICS ($T_A=25^\circ\text{C}$, Input: $t_R, t_F \leq 3\text{ns}$; $P_{RR} \leq 1\text{MHz}$)

PARAMETER	SYMBOL	TEST CONDITIONS	MIN	TYP	MAX	UNIT
Propagation delay time Input (A or B) to output(Y)	t_{PLH}	$V_{CC}=3.3V \pm 0.3V, C_L=15\text{pF}$		6.2	8.8	ns
	t_{PHL}			6.2	8.8	ns
	t_{PLH}	$V_{CC}=3.3V \pm 0.3V, C_L=50\text{pF}$		8.7	12.3	ns
	t_{PHL}			8.7	12.3	ns
Propagation delay time Input (A or B) to output(Y)	t_{PLH}	$V_{CC}=5V \pm 0.5V, C_L=15\text{pF}$		4.3	5.9	ns
	t_{PHL}			4.3	5.9	ns
	t_{PLH}	$V_{CC}=5V \pm 0.5V, C_L=50\text{pF}$		5.8	7.9	ns
	t_{PHL}			5.8	7.9	ns

■ OPERATING CHARACTERISTICS ($T_A=25^\circ\text{C}$, unless otherwise specified)

PARAMETER	SYMBOL	TEST CONDITIONS	MIN	TYP	MAX	UNIT
Power Dissipation Capacitance	C_{PD}	No load, $V_{CC}=5V, f=1\text{MHz}$		18		pF

■ TEST CIRCUIT AND WAVEFORMS

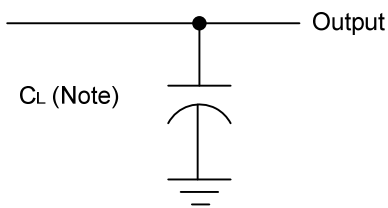

Note: CL includes probe and jig capacitance.

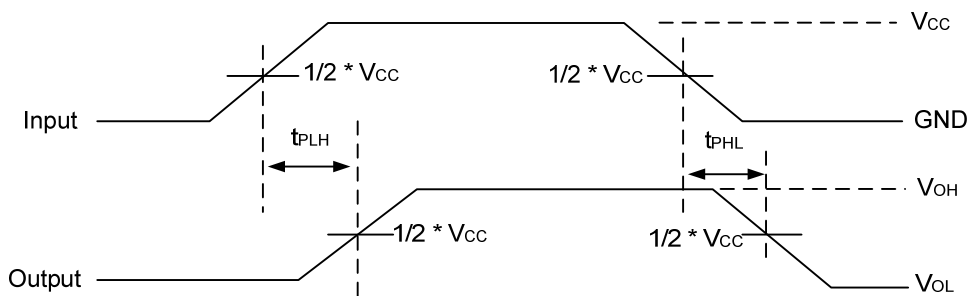

UTC assumes no responsibility for equipment failures that result from using products at values that exceed, even momentarily, rated values (such as maximum ratings, operating condition ranges, or other parameters) listed in products specifications of any and all UTC products described or contained herein. UTC products are not designed for use in life support appliances, devices or systems where malfunction of these products can be reasonably expected to result in personal injury. Reproduction in whole or in part is prohibited without the prior written consent of the copyright owner. UTC reserves the right to make changes to information published in this document, including without limitation specifications and product descriptions, at any time and without notice. This document supersedes and replaces all information supplied prior to the publication hereof.

X-ON Electronics

Largest Supplier of Electrical and Electronic Components

Click to view similar products for [Logic Gates](#) category:

Click to view products by [Unisonic](#) manufacturer:

Other Similar products are found below :

[74HC85N](#) [74LV32AT14-13](#) [NL17SG32DFT2G](#) [CD4068BE](#) [NL17SG86DFT2G](#) [NLV14001UBDR2G](#) [NLX1G11AMUTCG](#)
[NLX1G97MUTCG](#) [74LS38](#) [74LVC1G08Z-7](#) [74LVC32ADTR2G](#) [CD4025BE](#) [MC74HCT20ADTR2G](#) [NLV17SZ00DFT2G](#)
[NLV17SZ126DFT2G](#) [NLV27WZ17DFT2G](#) [NLV74HC02ADR2G](#) [74HC32S14-13](#) [74LS133](#) [74LVC1G32Z-7](#) [74LVC1G86Z-7](#)
[NLV74HC14ADR2G](#) [NLV74HC20ADR2G](#) [NLVVHC1G09DFT1G](#) [NLX2G86MUTCG](#) [74LVC2G32RA3-7](#) [74LVC2G00HD4-7](#)
[NL17SG02P5T5G](#) [74LVC2G86HK3-7](#) [NLV7SZ97DFT2G](#) [NLVVHC1G14DFT2G](#) [NLX1G99DMUTWG](#) [NLVVHC1G00DFT2G](#)
[NLV7SZ57DFT2G](#) [NLV74VHC04DTR2G](#) [NLV27WZ00USG](#) [NLU1G86CMUTCG](#) [NLU1G08CMUTCG](#) [NL17SZ32P5T5G](#)
[NL17SZ00P5T5G](#) [NL17SH02P5T5G](#) [74AUP2G00RA3-7](#) [NLVVHC1GT00DFT2G](#) [NLV74HC02ADTR2G](#) [NLX1G332CMUTCG](#)
[NLVHCT132ADTR2G](#) [NL17SG86P5T5G](#) [NL17SZ05P5T5G](#) [NLV74VHC00DTR2G](#) [NLVVHC1G02DFT1G](#)