



UM603A

LINEAR INTEGRATED CIRCUIT

DUAL OPERATIONAL AMPLIFIER AND CURRENT CONTROLLER

DESCRIPTION

The UTC **UM603A** is a monolithic IC that includes one independent op-amp and another op-amp for which the non inverting input is wired to a 2.5V fixed voltage reference. This device is offering space and cost saving in many applications like power supply management or data acquisition systems.

FEATURES

OPERATIONAL AMPLIFIER

- *Low input offset voltage: 0.5mV typ. for UTC **UM603A**
- *Low supply current: 350uA/op.(@ $V_{CC}= 5V$)
- *Medium bandwidth(unity gain): 0.9MHz
- *Large output voltage swing: 0V ~ ($V_{CC}-1.5V$)
- *Input common mode voltage range includes ground
- *Wide power supply range: 3V ~ 32V $\pm 1.5 \sim \pm 16V$

VOLTAGE REFERENCE

- *Fixed output voltage reference 2.5V
- * Reference voltage tolerance
 - UM603A-1: $\pm 0.4\%$
 - UM603A-2: $\pm 1\%$
- *Sink current capability : 1 ~ 100mA
- *Typical output impedance : 0.2 Ω

ORDERING INFORMATION

| Ordering Number | | Package | Packing |
|-----------------|---------------|---------|-----------|
| Lead Free | Halogen Free | | |
| UM603AL-S08-R | UM603AG-S08-R | SOP-8 | Tape Reel |
| UM603AL-P08-R | UM603AG-P08-R | TSSOP-8 | Tape Reel |

| | |
|---|--|
| <p>UM603AG-S08-R</p> <p>(1) Packing Type</p> <p>(2) Package Type</p> <p>(3) Green Package</p> | <p>(1) R: Tape Reel</p> <p>(2) S08: SOP-8, P08: TSSOP-8</p> <p>(3) G: Halogen Free and Lead Free, L: Lead Free</p> |
|---|--|

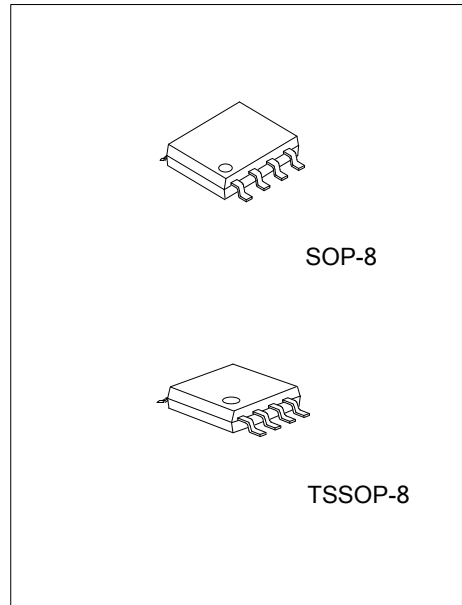

MARKING

| SOP-8 | TSSOP-8 |
|---|---|
| <p>UTC → Date Code L: Lead Free G: Halogen Free Lot Code</p> | <p>UTC → Date Code L: Lead Free G: Halogen Free Lot Code</p> |

PIN CONFIGURATION

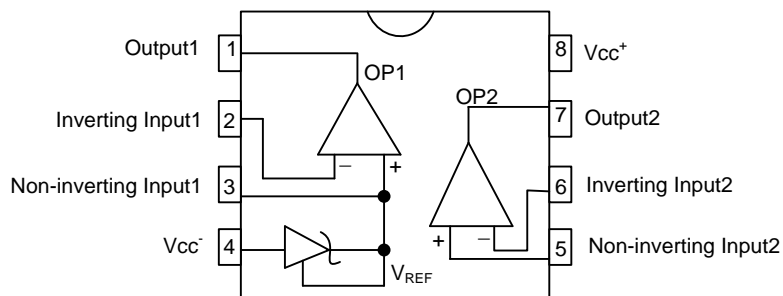

PIN DESCRIPTION

| PIN NO | PIN NAME | I/O | PIN DESCRIPTION |
|--------|----------------------|-----|---|
| 1 | Output 1 | O | OP1 output |
| 2 | Inverting Input1 | I | OP1 inverting input |
| 3 | Non-Inverting Input1 | O | A 2.5V fixed voltage reference output, wired to OP1 non-inverting input |
| 4 | V _{cc-} | | |
| 5 | Non-Inverting Input2 | I | OP2 non-inverting input |
| 6 | Inverting Input2 | I | OP2 inverting input |
| 7 | Output 2 | O | OP2 output |
| 8 | V _{cc+} | | |

■ ABSOLUTE MAXIMUM RATINGS

| PARAMETER | SYMBOL | RATING | UNIT |
|----------------------------|---------------|------------|------|
| Supply Voltage | V_{CC} | 36 | V |
| Differential Input Voltage | $V_{I(DIFF)}$ | 36 | V |
| Input Voltage | V_{IN} | -0.3 ~ +36 | V |
| Junction Temperature | T_J | +125 | °C |
| Operating Temperature | T_{OPR} | -55 ~ +125 | °C |

Note: Absolute maximum ratings are those values beyond which the device could be permanently damaged.

Absolute maximum ratings are stress ratings only and functional device operation is not implied.

■ THERMAL DATA

| PARAMETER | SYMBOL | RATING | UNIT |
|---------------------|---------|--------|------|
| Junction to Ambient | SOP-8 | 175 | °C/W |
| | TSSOP-8 | 120 | |

■ ELECTRICAL CHARACTERISTICS

| PARAMETER | SYMBOL | TEST CONDITIONS | MIN | TYP. | MAX | UNIT |
|--|----------|---|-----|------|-----|------|
| Total Supply Current, excluding Current in the Voltage Reference | I_{CC} | $V_{CC}^+=5V$, no load, $T_{MIN} \leq T_A \leq T_{MAX}$ | 0.7 | | 1.2 | mA |
| | | $V_{CC}^+=30V$, no load, $T_{MIN} \leq T_A \leq T_{MAX}$ | | | 2 | |

$V_{CC}^+=+5V$, $V_{CC}=\text{Ground}$, $T_A=25^\circ\text{C}$ (unless otherwise specified)

| PARAMETER | SYMBOL | TEST CONDITIONS | MIN | TYP | MAX | UNIT | |
|---|---------------|--|------------------------------------|---------------------------------|-----|------------------------------|----|
| OPERATOR1 (op-amp with non-inverting input connected to the internal V_{REF}) | | | | | | | |
| Input Offset Voltage | UM603A-1 | $V_{I(OFF)}$ | $V_{I(CM)}=0V$ | $T_A=25^\circ\text{C}$ | 0.5 | 2 | mV |
| | | | | $T_{MIN} \leq T_A \leq T_{MAX}$ | | 3 | |
| | UM603A-2 | $V_{I(OFF)}$ | $V_{I(CM)}=0V$ | $T_A=25^\circ\text{C}$ | 1 | 4 | mV |
| | | | | $T_{MIN} \leq T_A \leq T_{MAX}$ | | 5 | |
| Input Offset Voltage Drift | $DV_{I(OFF)}$ | | | 7 | | $\mu\text{V}/^\circ\text{C}$ | |
| Input Bias Current | $I_{I(BIAS)}$ | negative input | | 20 | | nA | |
| Large Signal Voltage Gain | A_{VD} | $V_{I(CM)}=0V$, $V_{CC}=15V$, $R_L=2k$ | | 100 | | V/mV | |
| Supply Voltage Rejection Ratio | SVR | $V_{I(CM)}=0V$, $V_{CC}=5V \sim 30V$ | 65 | 100 | | dB | |
| Output Current Source | I_{SOURCE} | $V_{OUT}=2V$, $V_{CC}=+15V$, $V_{ID}=+1V$ | 20 | 40 | | mA | |
| Short Circuit to Ground | I_{SC} | $V_{CC}=+15V$ | | 40 | 60 | mA | |
| Output Current Sink | I_{SINK} | $V_{ID}=-1V$, $V_{CC}=+15V$, $V_{OUT}=2V$ | 10 | 20 | | mA | |
| High Level Output Voltage | V_{OH} | $V_{CC}^+=30V$ | $T_A=25^\circ\text{C}$, $R_L=10k$ | 27 | | V | |
| | | | $T_{MIN} \leq T_A \leq T_{MAX}$ | 27 | 28 | | |
| Low Level Output Voltage | V_{OL} | $R_L=10k$ | | 5 | 20 | mV | |
| | | $T_{MIN} \leq T_A \leq T_{MAX}$ | | 5 | 20 | | |
| Slew Rate at Unity Gain | SR | $V_{IN}=0.5 \sim 3V$, $V_{CC}=15V$ $R_L=2k$, $C_L=100pF$, unity gain | 0.2 | 0.4 | | V/ μs | |
| Gain Bandwidth Product | G_{BP} | $V_{CC}=30V$, $R_L=2K$, $C_L=100pF$ $f=100kHz$, $V_{IN}=10mV$ | 0.5 | 0.9 | | MHz | |
| Total Harmonic Distortion | THD | $f=1kHz$, $C_L=100pF$, $V_{OUT}=2V_{PP}$ $A_v=20dB$, $R_L=2k$, $V_{CC}=30V$ | | 0.02 | | % | |

■ ELECTRICAL CHARACTERISTICS (Cont.)

$V_{CC}=\pm 5V$, $V_{CC}=\text{Ground}$, $V_{OUT}=1.4V$, $T_A=25^\circ\text{C}$ (unless otherwise specified)

| PARAMETER | SYMBOL | TEST CONDITIONS | MIN | TYP | MAX | UNIT |
|---|-----------------|--|------------------------------------|------|------------------------------|------------------|
| OPERATOR2 (independent op-amp)(Note 1) | | | | | | |
| Input Offset Voltage | UM603A-1 | $V_{I(OFF)}$ | $T_A=25^\circ\text{C}$ | 0.5 | 2 | mV |
| | | | $T_{MIN}\leq T_A\leq T_{MAX}$ | | 3 | |
| | UM603A-2 | | $T_A=25^\circ\text{C}$ | 1 | 4 | mV |
| | | | $T_{MIN}\leq T_A\leq T_{MAX}$ | | 5 | |
| Input Offset Voltage Drift | $DV_{I(OFF)}$ | | 7 | | $\mu\text{V}/^\circ\text{C}$ | |
| Input Offset Current | $I_{I(OFF)}$ | $T_A=25^\circ\text{C}$ | | 2 | 30 | nA |
| | | $T_{MIN}\leq T_A\leq T_{MAX}$ | | | 50 | |
| Input Bias Current | $I_{I(BIAS)}$ | $T_A=25^\circ\text{C}$ | | 20 | 150 | nA |
| | | $T_{MIN}\leq T_A\leq T_{MAX}$ | | | 200 | |
| Large Signal Voltage Gain | A_{VD} | $V_{CC}=15V$, $R_L=2k$, $V_{OUT}=1.4V\sim 11.4V$ | 50 | 100 | | V/mV |
| | | $T_{MIN}\leq T_A\leq T_{MAX}$ | 25 | | | |
| Supply Voltage Rejection Ratio | SVRR | $V_{CC}=5V\sim 30V$ | 65 | 100 | | dB |
| Input Common Mode Voltage Range | $V_{I(CM)}$ | $V_{CC}=\pm 30V$ (Note 1) | 0 | | $(V_{CC+})-1.5$ | V |
| | | $T_{MIN}\leq T_A\leq T_{MAX}$ | 0 | | $(V_{CC+})-2$ | |
| Common Mode Rejection Ratio | CMRR | | 70 | 85 | | dB |
| | | $T_{MIN}\leq T_A\leq T_{MAX}$ | 60 | | | |
| Output Current Source | $I_{O(SOURCE)}$ | $V_{CC}=\pm 15V$, $V_{OUT}=2V$, $V_{JD}=\pm 1V$ | 20 | 40 | | mA |
| Short Circuit to Ground | I_{SC} | $V_{CC}=\pm 15V$ | | 40 | 60 | mA |
| Output Current Sink | $I_{O(SINK)}$ | $V_{ID}=-1V$, $V_{CC}=\pm 15V$, $V_{OUT}=2V$ | 10 | 20 | | mA |
| High Level Output Voltage | V_{OH} | $V_{CC+}=30V$ | $T_A=25^\circ\text{C}$, $R_L=10k$ | 27 | 28 | V |
| | | | $T_{MIN}\leq T_A\leq T_{MAX}$ | 27 | | |
| Low Level Output Voltage | V_{OL} | $R_L=10k$ | | 5 | 20 | mV |
| | | $T_{MIN}\leq T_A\leq T_{MAX}$ | | 5 | 20 | |
| Slew Rate at Unity Gain | SR | $V_{IN}=0.5\sim 3V$, $V_{CC}=15V$ $R_L=2k$, $C_L=100pF$, unity gain | 0.2 | 0.4 | | V/ μs |
| Gain Bandwidth Product | GBP | $V_{CC}=30V$, $R_L=2K$, $C_L=100pF$ $f=100kHz$, $V_{IN}=10mV$ | 0.5 | 0.9 | | MHz |
| Total Harmonic Distortion | THD | $f=1kHz$, $C_L=100pF$, $V_{OUT}=2V_{PP}$ $A_V=20dB$, $R_L=2k$, $V_{CC}=30V$, | | 0.02 | | % |

■ VOLTAGE REFERENCE

| PARAMETER | SYMBOL | Value | UNIT |
|-----------------|--------|---------|------|
| Cathode Current | I_K | 1 ~ 100 | mA |

| PARAMETER | SYMBOL | TEST CONDITIONS | MIN | TYP | MAX | UNIT | |
|--|------------------|---|--|-------|-----|----------|---|
| Reference Input Voltage | UM603A-1 | V_{REF} | $\pm 0.4\%$, $T_A=25^\circ\text{C}$ | 2.49 | 2.5 | 2.51 | V |
| | | | $T_{MIN}\leq T_A\leq T_{MAX}$, $V_{KA}=V_{REF}$, $I_{KA}=10mA$ | 2.48 | | 2.52 | |
| | UM603A-2 | | $\pm 1\%$, $T_A=25^\circ\text{C}$ | 2.475 | 2.5 | 2.525 | |
| | | | $T_{MIN}\leq T_A\leq T_{MAX}$, $V_{KA}=V_{REF}$, $I_{KA}=10mA$ | 2.45 | | 2.55 | |
| Reference Input Voltage Deviation Over Temperature Range | ΔV_{REF} | $V_{KA}=V_{REF}$, $I_K=10mA$, $T_{MIN}\leq T_A\leq T_{MAX}$ | | 7 | 30 | mV | |
| Minimum Cathode Current for Regulation | I_{MIN} | $V_{KA}=V_{REF}$ | | 0.5 | 1 | mA | |
| Dynamic Impedance(Note 2) | Z_{KA} | $V_{KA}=V_{REF}$, $\Delta I_K=1\sim 100mA$, $f<1kHz$ | | 0.2 | 0.5 | Ω | |

Notes: 1. The input common-mode voltage of either input signal voltage should not be allowed to go negative by more than 0.3V. The upper end of the common-mode voltage range is $V_{CC+} - 1.5V$. But either of both inputs can go to +36V without damage.

2. The dynamic impedance is defined as $Z_{KA} = \frac{\Delta V_{KA}}{\Delta I_K}$.

■ TYPICAL APPLICATION CIRCUIT

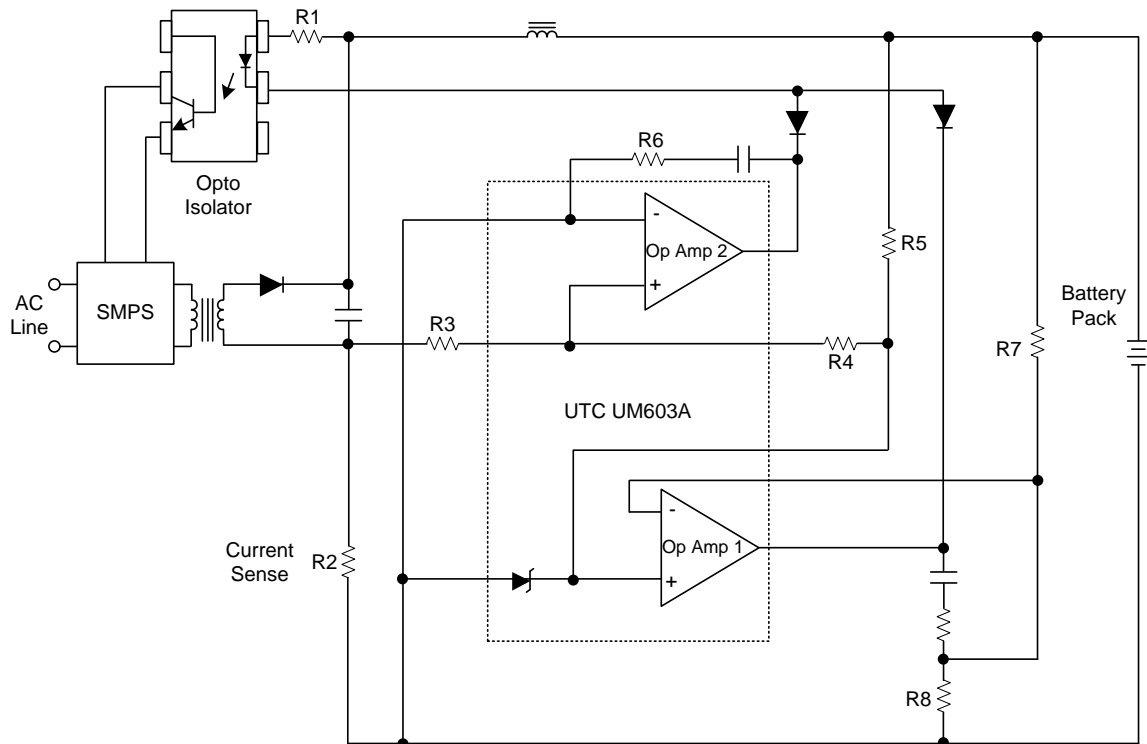

$$V_{OUT} = V_{REF} \times \frac{R_7 + R_8}{R_8}$$

$$V_{SENSE} = V_{REF} \times \frac{R_3}{R_3 + R_4} \text{ (Pin 5)}$$

$$\text{Current Limie} = \frac{V_{SENSE}}{R_2}$$

Application of UTC UM603A in a Constant Current and Constant Voltage Charger

TYPICAL CHARACTERISTICS

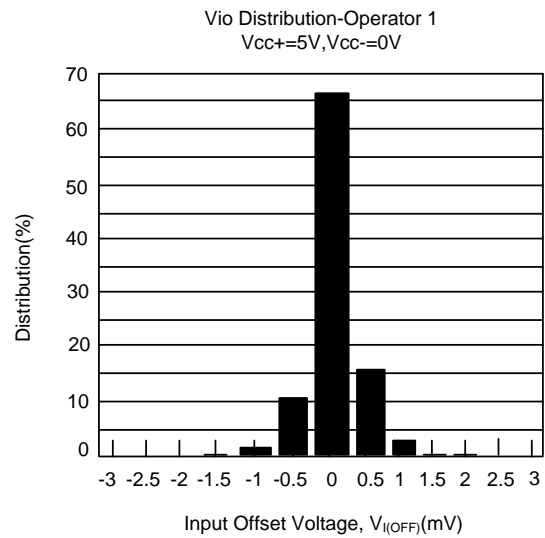
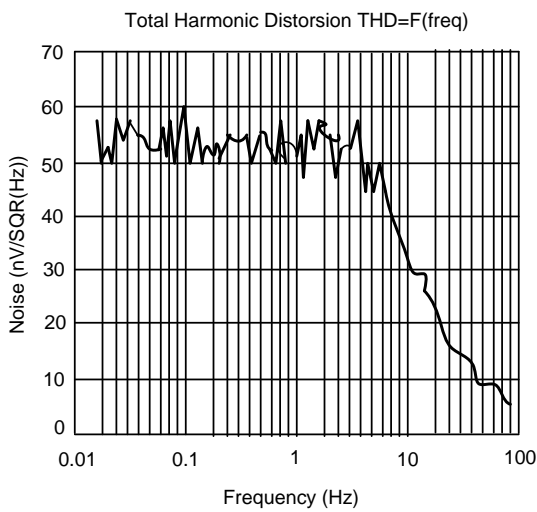
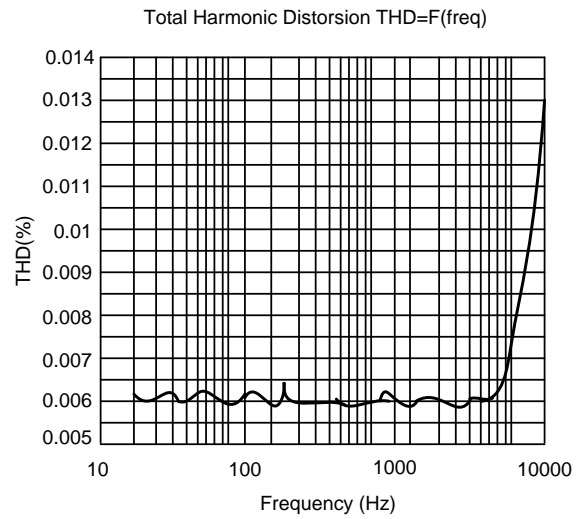
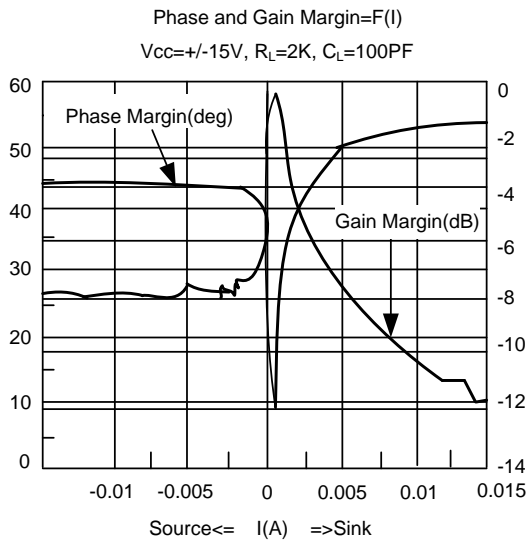
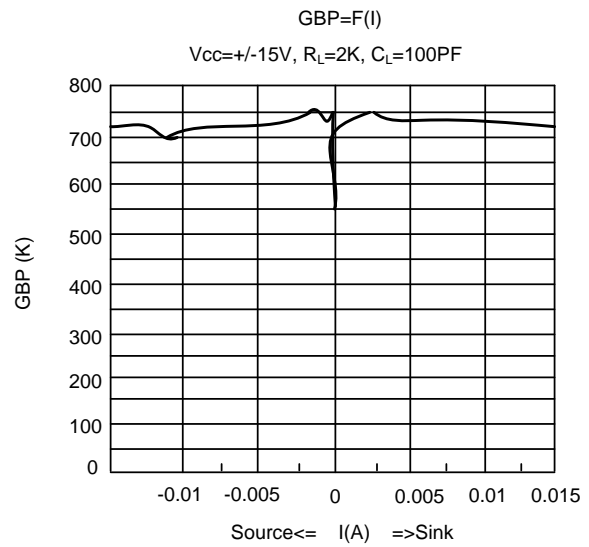
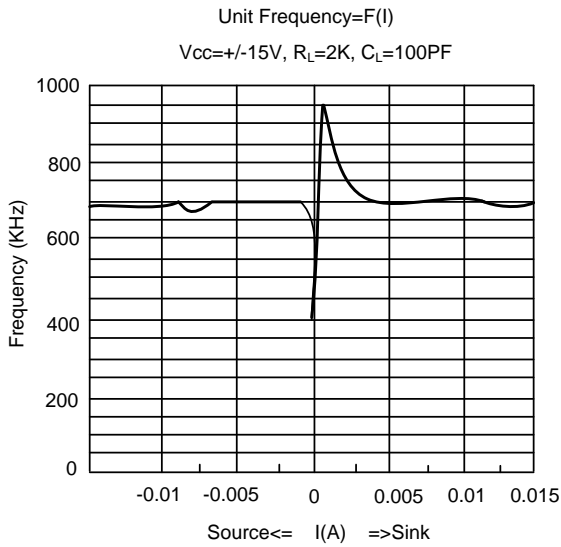

■ TYPICAL CHARACTERISTICS(Cont.)

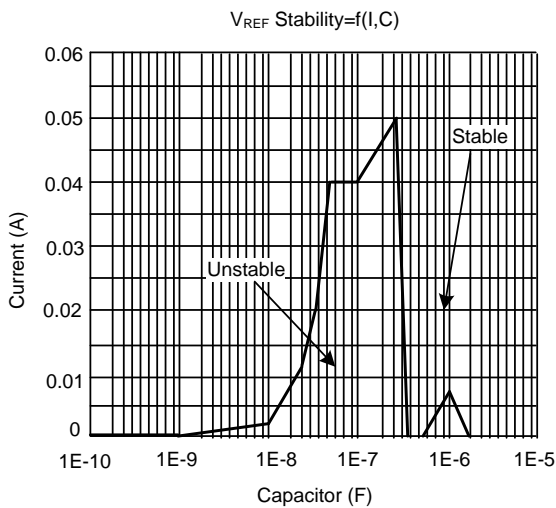
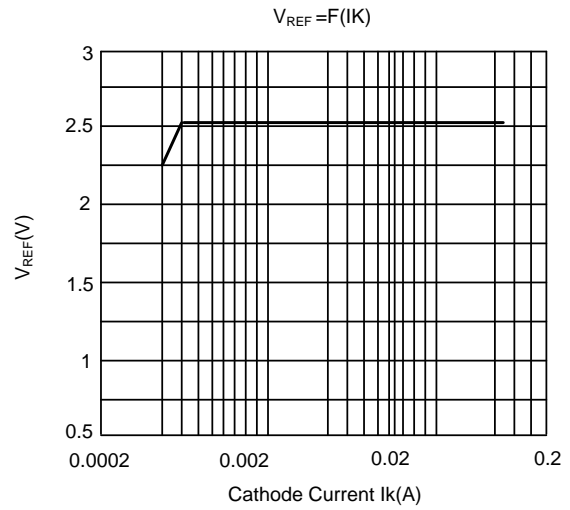
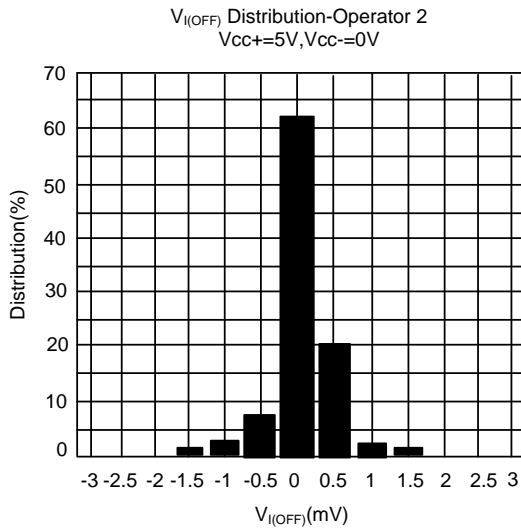

UTC assumes no responsibility for equipment failures that result from using products at values that exceed, even momentarily, rated values (such as maximum ratings, operating condition ranges, or other parameters) listed in products specifications of any and all UTC products described or contained herein. UTC products are not designed for use in life support appliances, devices or systems where malfunction of these products can be reasonably expected to result in personal injury. Reproduction in whole or in part is prohibited without the prior written consent of the copyright owner. UTC reserves the right to make changes to information published in this document, including without limitation specifications and product descriptions, at any time and without notice. This document supersedes and replaces all information supplied prior to the publication hereof.

X-ON Electronics

Largest Supplier of Electrical and Electronic Components

Click to view similar products for [Operational Amplifiers - Op Amps](#) category:

Click to view products by [Unisonic](#) manufacturer:

Other Similar products are found below :

[430227FB](#) [UPC451G2-A](#) [UPC824G2-A](#) [LT1678IS8](#) [UPC258G2-A](#) [NCV33202DMR2G](#) [NJM324E](#) [M38510/13101BPA](#) [NTE925](#)
[AZV358MTR-G1](#) [AP4310AUMTR-AG1](#) [AZV358MMTR-G1](#) [SCY33178DR2G](#) [NCV5652MUTWG](#) [NCV20034DR2G](#) [NTE778S](#) [NTE871](#)
[NTE937](#) [MCP6V16UT-E/OT](#) [SCY6358ADR2G](#) [UPC4570G2-E1-A](#) [NCS20282FCTTAG](#) [UPC834G2-E1-A](#) [UPC1458G2-E2-A](#) [UPC813G2-](#)
[E2-A](#) [UPC458G2-E1-A](#) [UPC824G2-E2-A](#) [UPC4574G2-E2-A](#) [UPC4558G2-E2-A](#) [UPC4560G2-E1-A](#) [UPC258G2-E1-A](#) [UPC4742GR-9LG-](#)
[E1-A](#) [UPC4742G2-E1-A](#) [UPC832G2-E2-A](#) [UPC842G2-E1-A](#) [UPC802G2-E1-A](#) [UPC4741G2-E2-A](#) [UPC4572G2-E2-A](#) [UPC844GR-9LG-](#)
[E2-A](#) [UPC259G2-E1-A](#) [UPC4741G2-E1-A](#) [UPC4558G2-E1-A](#) [UPC1251GR-9LG-E1-A](#) [UPC4744G2-E1-A](#) [UPC4092G2-E1-A](#)
[UPC4574G2-E1-A](#) [UPC4062G2-E2-A](#) [UPC451G2-E2-A](#) [UPC832G2-E1-A](#) [UPC844GR-9LG-E1-A](#)