



UR133/A

LINEAR INTEGRATED CIRCUIT

300/500mA LOW DROPOUT LINEAR VOLTAGE REGULATORS

■ DESCRIPTION

The UTC **UR133/A** are 300/500mA fixed output voltage low dropout linear regulators. Wide range of available output voltage fits most of applications. Built-in output current-limiting most thermal-limiting provide maximal protection against any fault conditions.

■ FEATURES

- *Guaranteed 300/500mA output current
- *Input voltage range up to 12V
- *Extremely tight load regulation
- *Fast transient response
- *Current-limiting and Thermal-limiting
- *Three-terminal adjustable or fixed 1.5V, 1.8V, 2.2V, 2.5V, 2.7V, 2.8V, 2.9V, 3.0V, 3.3V, 3.5V, 3.6V, 3.7V, 4.7V, 5.0V

■ ORDERING INFORMATION

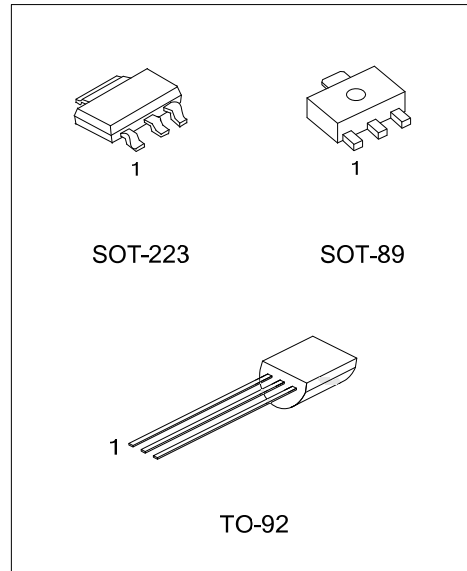

Ordering Number		Package	② Pin Assignment	Packing
Lead Free	Halogen Free			
UR133①L-xx-AA3-②-③	UR133①G-xx-AA3-②-③	SOT-223	A: GOI B: OGI C: GIO D: IGO	R: Tape Reel B: Tape Box K: Bulk
UR133①L-xx-AB3-②-③	UR133①G-xx-AB3-②-③	SOT-89		
UR133①L-xx-T92-②-③	UR133①G-xx-T92-②-③	TO-92		
UR133①L-xx-T92-②-③	UR133①G-xx-T92-②-③	TO-92		

- Note: 1. ①: Current code: Blank: 300mA A: 500mA
 2. Pin assignment: I:V_{IN}(Positive Power Input) O:V_{OUT}(Output) G:GND(Ground/Adjustable)
 3. xx: Output Voltage, refer to Marking Information.

<p>UR133①L-xx-AB3-②-③</p> <p>(1)Packing Type (2)Pin Assignment (3)Package Type (4)Output Voltage Code (5)Lead Plating (6)Current Code</p>	<p>(1) B: Tape Box, K: Bulk, R: Tape Reel (2) refer to Pin Assignment (3) AA: SOT-223, AB3: SOT-89, T92: TO-92 (4) xx: refer to Marking Information (5) G: Halogen Free, L: Lead Free (6) Blank: 300mA A: 500mA</p>
---------------------------------------------------------------------------------------------------------------------------------------------------------------	-----------------------------------------------------------------------------------------------------------------------------------------------------------------------------------------------------------------------------------------

UR133/A

LINEAR INTEGRATED CIRCUIT

MARKING INFORMATION

PACKAGE	VOLTAGE CODE	PIN CODE	PIN 1	PIN 2	PIN 3	MARKING
SOT-89	15:1.5V 18:1.8V 22:2.2V 25:2.5V	A	G	O	I	
		B	O	G	I	
		C	G	I	O	
		D	I	G	O	
TO-92	27:2.7V 28:2.8V 29:2.9V 30:3.0V 33:3.3V 35:3.5V 36:3.6V 37:3.7V	A	G	O	I	
		B	O	G	I	
		C	G	I	O	
		D	I	G	O	
SOT-223	47:4.7V 50:5.0V AD:ADJ	A	G	O	I	
		B	O	G	I	
		C	G	I	O	
		D	I	G	O	

■ ABSOLUTE MAXIMUM RATINGS

PARAMETER		SYMBOL	RATINGS	UNIT
Input Voltage V_{IN}		V_{IN}	-0.3 ~ +12	V
Power Dissipation	SOT-89	P_D	500	mW
	TO-92		600	mW
	SOT-223		800	mW
Operating Temperature		T_{OPR}	-40 ~ +85	°C
Storage Temperature		T_{STG}	-65 ~ +150	°C
Note: Absolute maximum ratings are those values beyond which the device could be permanently damaged. Absolute maximum ratings are stress ratings only and functional device operation is not implied.				

■ THERMAL DATA

PARAMETER		SYMBOL	RATINGS	UNIT
Junction to Case	SOT-89	θ_{JC}	100	°C/W
	SOT-223		15	°C/W
Junction to Ambient	SOT-89	θ_{JA}	300	°C/W
	TO-92		160	°C/W
	SOT-223		60	°C/W

■ ELECTRICAL CHARACTERISTICS ($T_A=25^\circ\text{C}$, $C_{IN}=1\mu\text{F}$, $C_{OUT}=10\mu\text{F}$, unless otherwise specified)

For UR133/A-1.5V, 1.8V, 2.2V, 2.5V, 2.7V, 2.8V, 2.9V, 3.0V

PARAMETER		SYMBOL	TEST CONDITIONS	MIN	TYP	MAX	UNIT
Output Voltage-UR133/A		V_{OUT}	$I_L=2\text{mA}$, $V_{IN}-V_{OUT}=1.4\text{V}$	1.47	1.50	1.53	V
				1.77	1.80	1.83	V
				2.16	2.20	2.24	V
				2.45	2.50	2.55	V
				2.65	2.70	2.75	V
				2.74	2.80	2.86	V
				2.84	2.90	2.96	V
				2.94	3.00	3.06	V
Dropout Voltage (note 4,5)	UR133	V_D	$I_L=300\text{mA}$			1.5	V
	UR133A		$I_L=500\text{mA}$				
Line Regulation		ΔV_{OUT}	$I_L=2\text{mA}$, $V_{IN}-V_{OUT}=2\text{V} \sim V_{IN}=9\text{V}$			0.5	% V_{OUT}
Load Regulation (Note 2)	UR133	ΔV_{OUT}	$I_L=2\text{mA} \sim 300\text{mA}$, $V_{IN}-V_{OUT}=2\text{V}$		10	30	mV
	UR133A		$I_L=2\text{mA} \sim 500\text{mA}$, $V_{IN}-V_{OUT}=2\text{V}$		10	50	mV
Current Limit (Note 3)	UR133	I_{LIMIT}	$V_{IN}-V_{OUT}=2\text{V}$, $V_{OUT}=0\text{V}$		350		mA
	UR133A				550		mA
Standby Current		I_{ST-BY}	$I_L=0$, $V_{IN}=9\text{V}$			5.0	mA
Output Voltage Temperature Coefficient					50	150	PPM/°C

■ ELECTRICAL CHARACTERISTICS(Cont.)

For UR133/A-ADJ 3.3V, 3.5V, 3.6V, 3.7V, 4.7V, 5.0V

PARAMETER	SYMBOL	TEST CONDITIONS	MIN	TYP	MAX	UNIT	
ADJUSTABLE (R1=120Ω, R2=200Ω, V_{OUT}=3.3V)							
Reference Voltage	V _{REF}	V _{IN} -V _{OUT} =2V, I _L =2mA	1.238	1.250	1.262	V	
Output Voltage-UR133/A	V _{OUT}	I _L =2mA, V _{IN} -V _{OUT} =1.4V	3.23	3.30	3.37	V	
			3.43	3.50	3.57	V	
			3.53	3.60	3.67	V	
			3.63	3.70	3.77	V	
			4.61	4.70	4.79	V	
			4.90	5.00	5.10	V	
Dropout Voltage (Notes 4, 5)	UR133	V _D	I _L =300mA		1.3	V	
	UR133A		I _L =500mA				
	UR133-ADJ	V _D	I _L =300mA		1.5	V	
	UR133A-ADJ		I _L =500mA				
Line Regulation	ΔV _{OUT}	I _L =2mA, V _{IN} -V _{OUT} =2V ~ V _{IN} =12V			0.5	%V _{OUT}	
Load Regulation (Note 2)	UR133	ΔV _{OUT}	I _L =2mA ~ 300mA, V _{IN} -V _{OUT} =2V		10	30	mV
	UR133A		I _L =2mA ~ 500mA, V _{IN} -V _{OUT} =2V		10	50	mV
Current Limit (Note 3)	UR133	I _{LIMIT}	V _{IN} -V _{OUT} =2V, V _{OUT} =0V		350		mA
	UR133A				550		mA
Standby current	I _{ST-BY}	I _L =0, V _{IN} =12V			5.0	mA	
Adjust Pin Current	I _{ADJ}	V _{IN} =12V			120	μA	
Adjust Pin Current Change	UR133	ΔI _{ADJ}	V _{IN} =2.75V~12V, I _L =1mA~300mA			5	μA
	UR133A		V _{IN} =2.75V~12V, I _L =1mA~500mA			5	μA
Output Voltage Temperature Coefficient				50	150	PPM/°C	

Note 1: Guaranteed by design.

2: Regulation is measured at constant junction temperature, using pulsed ON time.

3: Current Limit is measured at constant junction temperature, using pulsed ON time.

4: Dropout is measured at constant junction temperature, using pulsed ON time, and the criterion is V_{OUT} inside target value ±2%.

5: Dropout test is skipped at the condition of V_{IN}<3V.

■ TYPICAL APPLICATION CIRCUIT

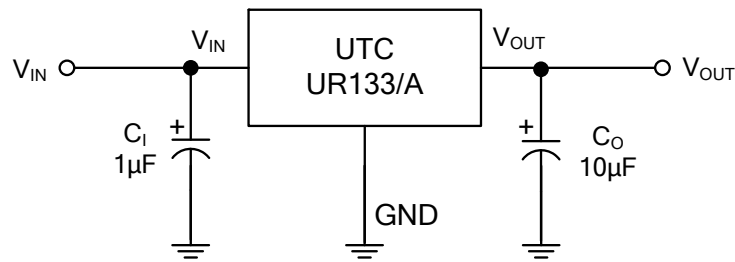

■ APPLICATION INFORMATION

A 10µF (or larger) capacitor is recommended between V_{OUT} and GND for stability. The part may oscillate without the capacitor. Any type of capacitor can be used, but not Aluminum electrolytics when operating below -25°C . The capacitance may be increased without limit.

A 1µF capacitor (or larger) should be placed between V_{IN} to GND.

UR133/A ADJUSTABLE

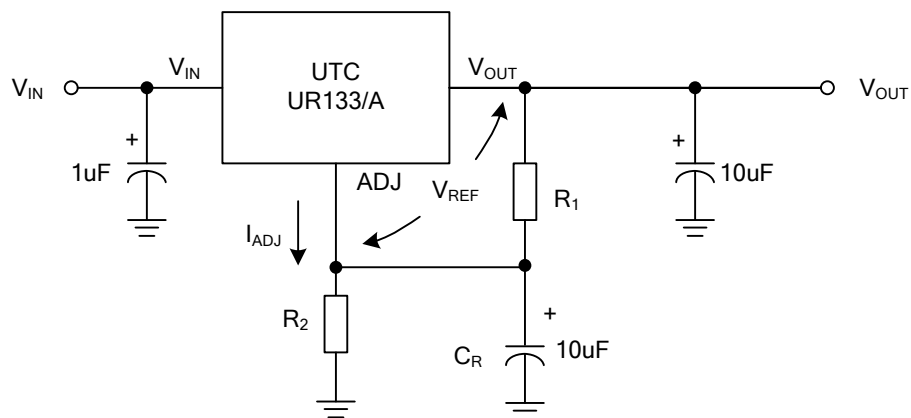

C_R : 10µF to improve ripple rejection

$$V_{OUT} = V_{REF}(1 + R_2/R_1) + I_{ADJ} * R_2$$

TYPICAL CHARACTERISTICS

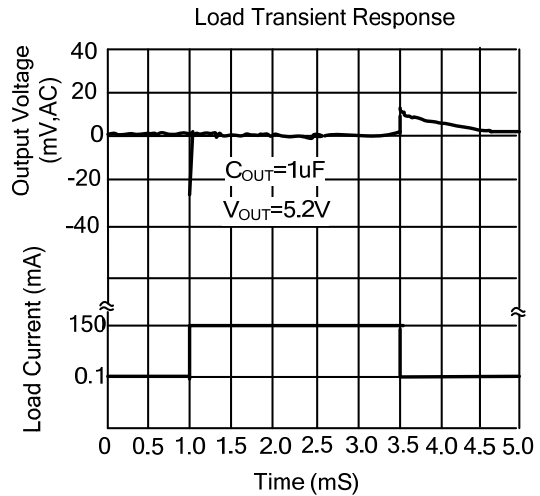
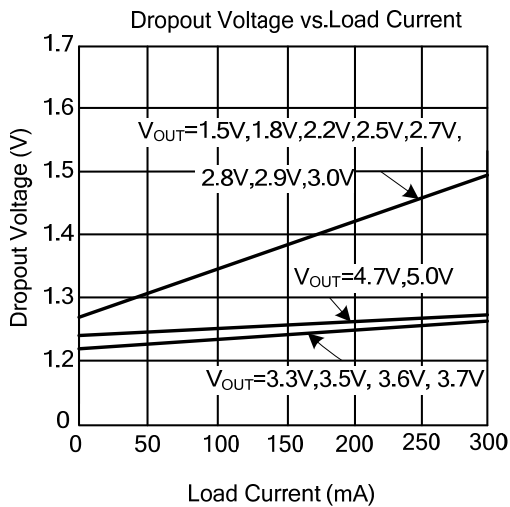
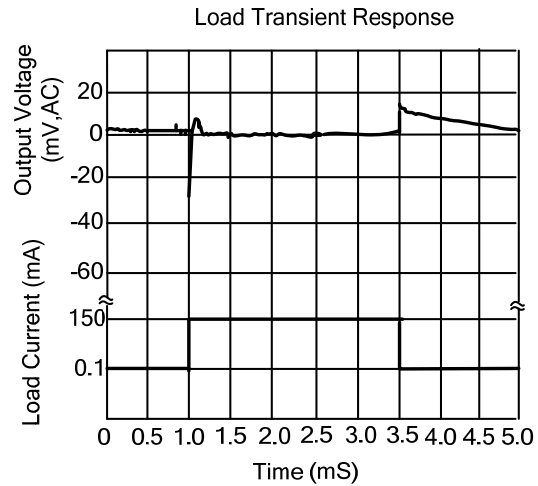
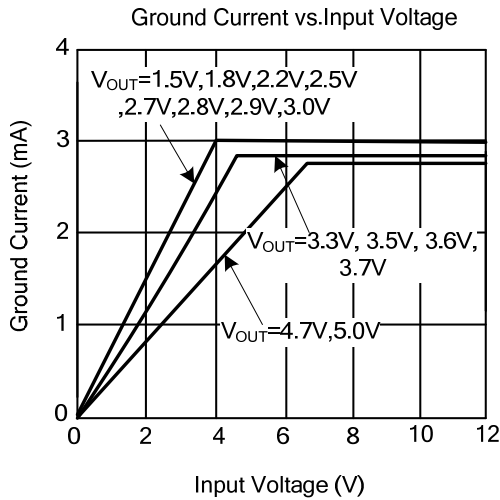
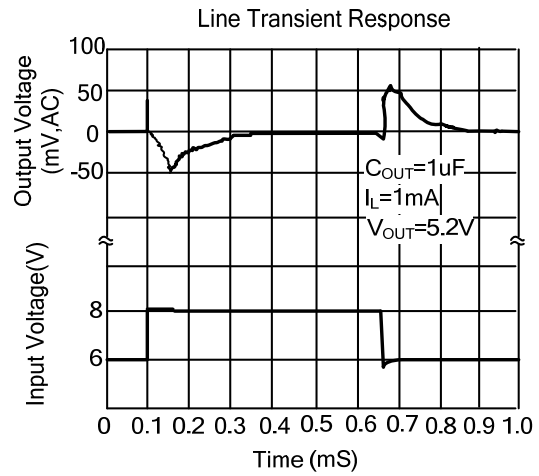
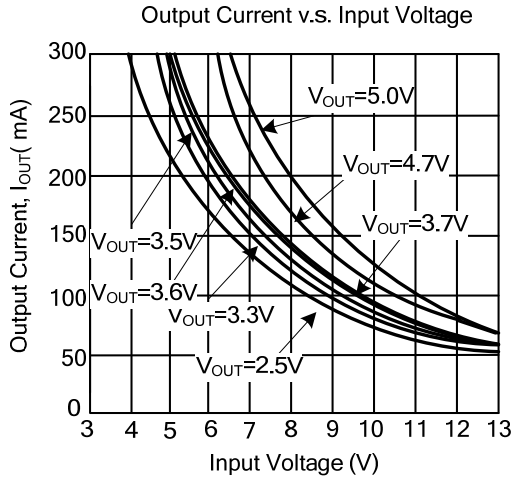

TYPICAL CHARACTERISTICS(Cont.)

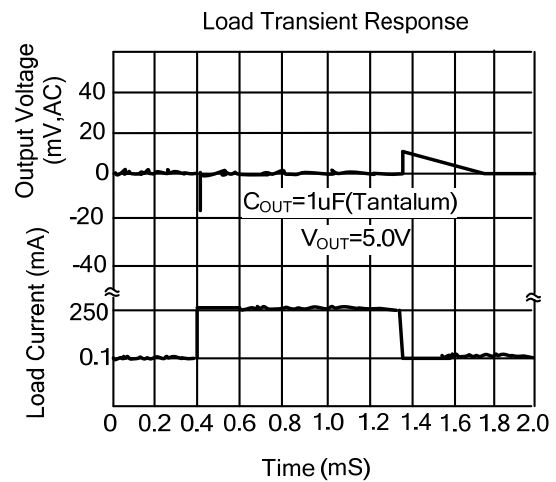
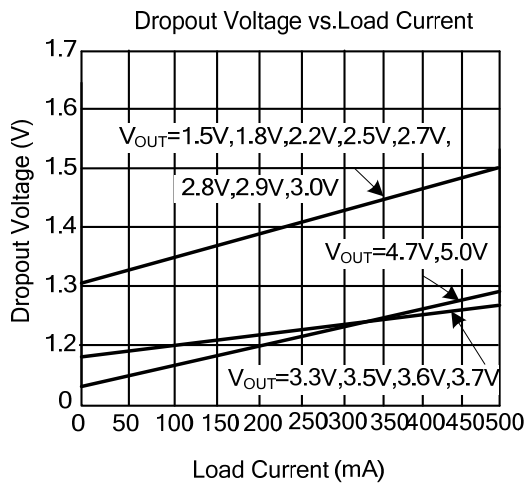
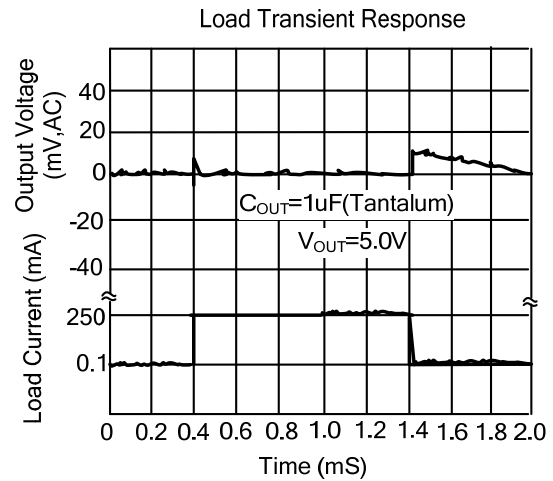
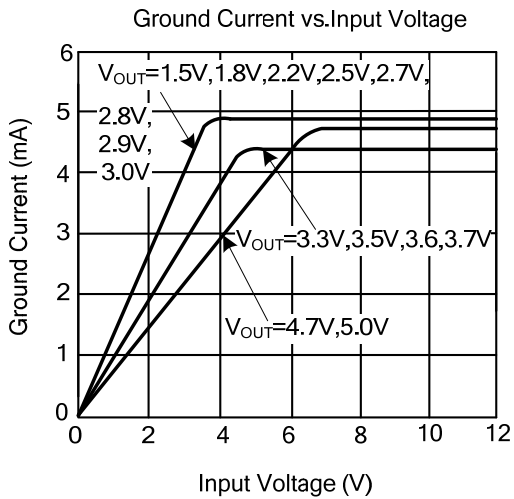
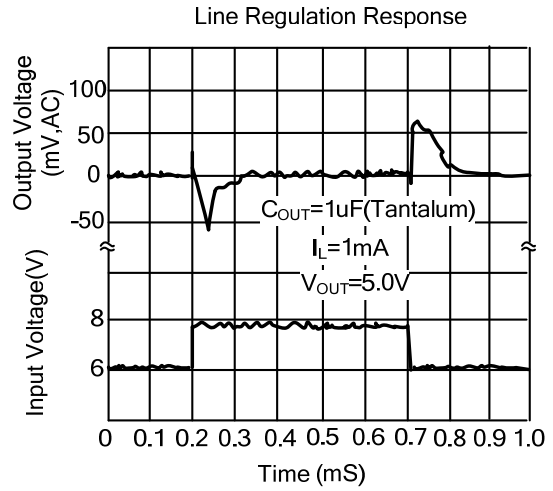
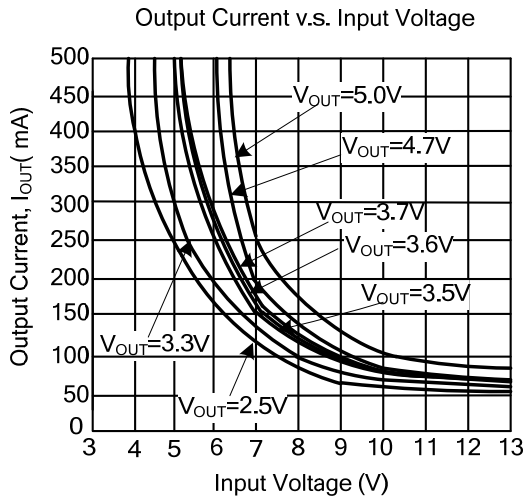

UTC assumes no responsibility for equipment failures that result from using products at values that exceed, even momentarily, rated values (such as maximum ratings, operating condition ranges, or other parameters) listed in products specifications of any and all UTC products described or contained herein. UTC products are not designed for use in life support appliances, devices or systems where malfunction of these products can be reasonably expected to result in personal injury. Reproduction in whole or in part is prohibited without the prior written consent of the copyright owner. The information presented in this document does not form part of any quotation or contract, is believed to be accurate and reliable and may be changed without notice.

X-ON Electronics

Largest Supplier of Electrical and Electronic Components

Click to view similar products for [LDO Voltage Regulators](#) category:

Click to view products by [Unisonic](#) manufacturer:

Other Similar products are found below :

[AP7363-SP-13](#) [L79M05TL-E](#) [AP7362-HA-7](#) [PT7M8202B12TA5EX](#) [TCR3DF185,LM\(CT](#) [TCR3DF45,LM\(CT](#) [TLE4473G V52](#) [059985X](#)
[NCP4687DH15T1G](#) [701326R](#) [NCV8170AXV250T2G](#) [AP7315-25W5-7](#) [AP2111H-1.2TRG1](#) [ZLDO1117QK50TC](#) [AZ1117ID-ADJTRG1](#)
[TCR3DG12,LF](#) [MIC5514-3.3YMT-T5](#) [SCD7912BTG](#) [NCP154MX180270TAG](#) [SCD33269T-5.0G](#) [NCV8170BXV330T2G](#)
[NCV8170BMX330TCG](#) [NCV8170AMX120TCG](#) [NCP706ABMX300TAG](#) [NCP153MX330180TCG](#) [NCP114BMX075TCG](#) [MC33269T-3.5G](#)
[CAT6243-ADJCMT5T](#) [TCR3DG33,LF](#) [TCR4DG35,LF](#) [TAR5S15U\(TE85L,F\)](#) [TAR5S18U\(TE85L,F\)](#) [TCR3UG19A,LF](#) [TCR4DG105,LF](#)
[MPQ2013AGG-5-P](#) [NCV8170AMX360TCG](#) [TLE4268GSXUMA2](#) [NCP715SQ15T2G](#) [MIC5317-3.0YD5-T5](#) [NCV563SQ18T1G](#)
[NCP715MX30TBG](#) [NCV8702MX25TCG](#) [NCV8170BXV120T2G](#) [MIC5317-1.2YD5-T5](#) [NCV8170AMX150TCG](#) [NCV8170BMX150TCG](#)
[AP2213D-3.3TRG1](#) [NCV8170BMX120TCG](#) [NCV8170BMX310TCG](#) [NCV8170BMX360TCG](#)