



UR6225

CMOS IC

POSITIVE VOLTAGE REGULATOR

DESCRIPTION

The UTC **UR6225** is a positive voltage output, three-pin regulator that provides a high current even when the input/output voltage differential is small. Low power consumption and high accuracy is achieved through CMOS and laser trimming technologies.

The UTC **UR6225** consists of a high-precision voltage reference, an error amplification circuit, and a current limited output driver. Transient responses to load variations have improved in comparison to the existing series.

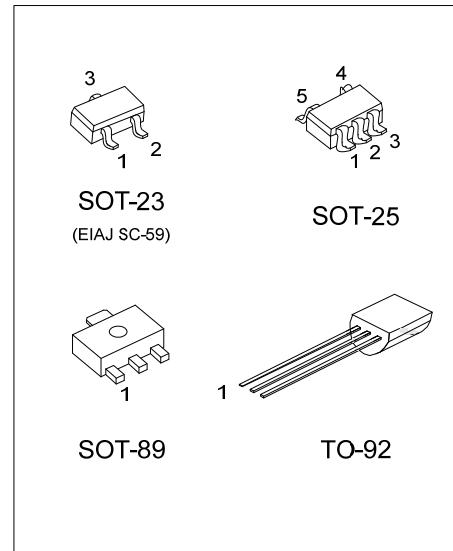

FEATURES

- * Maximum Output Current: 300mA (Within Max. Power Dissipation, $V_{OUT} = 5.0V$)
- * Output Voltage Range: 1.5V ~ 6.0V in 0.1V Increments (1.5V ~ 1.9V for Custom Products)
- * Highly Accurate: Output Voltage $\pm 2\%$ ($\pm 1\%$ for Semi-Custom Products)
- * Low Power Consumption: Typ. 2.0 μA @ $V_{OUT} = 5.0V$
- * Output Voltage Temperature Characteristics: Typ. $\pm 100ppm/^{\circ}C$
- * Input Stability : Typ. 0.2%/V
- * Small Input-Output Differential: $I_{OUT} = 100mA$ @ $V_{OUT} = 5.0V$ with a 0.12V Differential.

ORDERING INFORMATION

Ordering Number		Package	Pin Assignment					Packing
Lead Free	Halogen Free		1	2	3	4	5	
UR6225L-xx-AB3-C-R	UR6225G-xx-AB3-C-R	SOT-89	G	I	O	-	-	Tape Reel
UR6225L-xx-AE3-3-R	UR6225G-xx-AE3-3-R	SOT-23	G	O	I	-	-	Tape Reel
UR6225L-xx-AF5-C-R	UR6225G-xx-AF5-C-R	SOT-25	I	G	N	N	O	Tape Reel
UR6225L-xx-AF5-F-R	UR6225G-xx-AF5-F-R	SOT-25	G	I	O	N	N	Tape Reel
UR6225L-xx-T92-C-B	UR6225G-xx-T92-C-B	TO-92	G	I	O	-	-	Tape Box
UR6225L-xx-T92-C-K	UR6225G-xx-T92-C-K	TO-92	G	I	O	-	-	Bulk
UR6225L-xx-T92-B-B	UR6225G-xx-T92-B-B	TO-92	O	G	I	-	-	Tape Box
UR6225L-xx-T92-B-K	UR6225G-xx-T92-B-K	TO-92	O	G	I	-	-	Bulk

Note: Pin Assignment: I: V_{IN} O: V_{OUT} G: V_{SS} N: No Connection
xx: Output Voltage, refer to Marking Information.

<p>UR6225G-xx-AB3-C-R</p>	<p>(1) R:Tape Reel, K:Bulk, B:Tape Box (2) refer to Pin Assignment (3) AB3:SOT-89, AE3:SOT-23, AF5:SOT-25, T92:TO-92 (4) xx:refer to Marking Information (5) G: Halogen Free and Lead Free, L: Lead Free</p>
---------------------------	--

MARKING INFORMATION

PACKAGE	VOLTAGE CODE	MARKING
SOT-89	15:1.5V 18:1.8V 20:2.0V	<p>Date Code ← UR6225 → Voltage Code L: Lead Free G: Halogen Free</p>
SOT-25	21:2.1V 25:2.5V 26:2.6V 27:2.7V 28:2.8V 2J:2.85V	<p>Voltage Code ← F2XX → Pin Code L: Lead Free G: Halogen Free</p>
SOT-23	30:3.0V 31:3.1V 33:3.3V 35:3.5V 36:3.6V 38:3.8V	<p>Voltage Code ← F2XX → L: Lead Free G: Halogen Free</p>
TO-92	40:4.0V 45:4.5V 50:5.0V 60:6.0V	<p>Pin Code ← UTC UR6225 → Voltage Code Date Code ← UR6225 → L: Lead Free G: Halogen Free</p>

BLOCK DIAGRAM

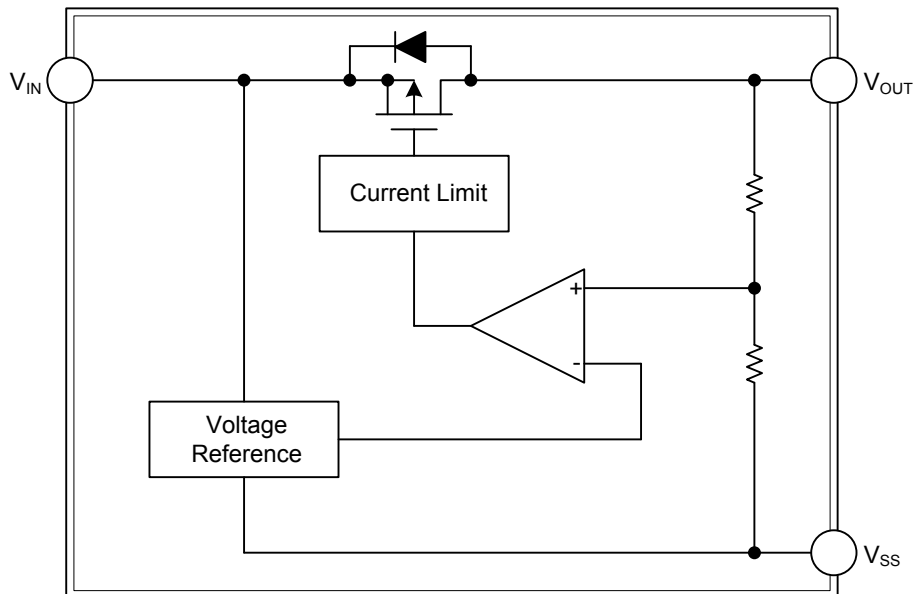

■ ABSOLUTE MAXIMUM RATINGS ($T_A=25^\circ\text{C}$, unless otherwise specified)

PARAMETER	SYMBOL	RATINGS	UNIT
Input Voltage	V_{IN}	10	V
Output Current	I_{OUT}	300	mA
Output Voltage	V_{OUT}	$V_{SS}-0.3 \sim V_{IN}+0.3$	V
Power Dissipation	SC-23/SOT-25	250	mW
	SOT-89	500	mW
	TO-92	300	mW
Junction Temperature	T_J	+125	$^\circ\text{C}$
Operating Temperature	T_{OPR}	-40 ~ +85	$^\circ\text{C}$
Storage Temperature	T_{STG}	-40~+125	$^\circ\text{C}$

Note: Absolute maximum ratings are those values beyond which the device could be permanently damaged. Absolute maximum ratings are stress ratings only and functional device operation is not implied.

■ ELECTRICAL CHARACTERISTICS ($T_A=25^\circ\text{C}$, unless otherwise specified)

UR6225-6.0V (Note1)

PARAMETER	CIRCUIT	SYMBOL	TEST CONDITIONS	MIN	TYP	MAX	UNIT
Output Voltage	1	$V_{OUT(E)}$ (Note2)	$I_{OUT}=40\text{mA}$, $V_{IN}=7.0\text{V}$	5.880	6.000	6.120	V
Maximum Output Current	1	$I_{OUT(MAX)}$	$V_{IN}=7.0\text{V}$, $V_{OUT(E)}\geq 5.4\text{V}$	250			mA
Minimum Load Current		$I_{OUT(MIN)}$	$V_{IN}=V_{OUT}+1\text{V}$			50	μA
Load Stability	1	ΔV_{OUT}	$V_{IN}=7.0\text{V}$, $1\text{mA}\leq I_{OUT}\leq 100\text{mA}$		40	80	mV
Input-Output Voltage	1	V_{DIF1}	$I_{OUT}=100\text{mA}$		120		mV
Differential (Note3)	1	V_{DIF2}	$I_{OUT}=200\text{mA}$		380		mV
Supply Current	2	I_{SS}	$V_{IN}=7.0\text{V}$		2.0	4.5	μA
Input Stability	1	$\frac{\Delta V_{OUT}}{\Delta V_{IN} \times V_{OUT}}$	$I_{OUT}=40\text{mA}$ $7.0\text{V}\leq V_{IN}\leq 10\text{V}$		0.2	0.3	%/V
Input Voltage		V_{IN}	$I_{OUT}=5\text{mA}$			10	V
Output Voltage Temperature Characteristics	1	$\frac{\Delta V_{OUT}}{\Delta T_{OPR} \times V_{OUT}}$	$I_{OUT}=40\text{mA}$ $-40^\circ\text{C}\leq T_{OPR}\leq 85^\circ\text{C}$		± 100		ppm/ $^\circ\text{C}$

UR6225-5.0V (Note1)

PARAMETER	CIRCUIT	SYMBOL	TEST CONDITONS	MIN	TYP	MAX	UNIT
Output Voltage	1	$V_{OUT(E)}$ (Note2)	$I_{OUT}=40\text{mA}$, $V_{IN}=6.0\text{V}$	4.900	5.000	5.100	V
Maximum Output Current	1	$I_{OUT(MAX)}$	$V_{IN}=6.0\text{V}$, $V_{OUT(E)}\geq 4.5\text{V}$	250			mA
Minimum Load Current		$I_{OUT(MIN)}$	$V_{IN}=V_{OUT}+1\text{V}$			50	μA
Load Stability	1	ΔV_{OUT}	$V_{IN}=6.0\text{V}$, $1\text{mA}\leq I_{OUT}\leq 100\text{mA}$		40	80	mV
Input-Output Voltage	1	V_{DIF1}	$I_{OUT}=100\text{mA}$		120		mV
Differential(Note3)	1	V_{DIF2}	$I_{OUT}=200\text{mA}$		380		mV
Supply Current	2	I_{SS}	$V_{IN}=6.0\text{V}$		2.0	4.5	μA
Input Stability	1	$\frac{\Delta V_{OUT}}{\Delta V_{IN} \times V_{OUT}}$	$I_{OUT}=40\text{mA}$ $6.0\text{V}\leq V_{IN}\leq 10\text{V}$		0.2	0.3	%/V
Input Voltage		V_{IN}	$I_{OUT}=5\text{mA}$			10	V
Output Voltage Temperature Characteristics	1	$\frac{\Delta V_{OUT}}{\Delta T_{OPR} \times V_{OUT}}$	$I_{OUT}=40\text{mA}$ $-40^\circ\text{C}\leq T_{OPR}\leq 85^\circ\text{C}$		± 100		ppm/ $^\circ\text{C}$

■ ELECTRICAL CHARACTERISTICS (Cont.)

UR6225-4.5V (Note1)

PARAMETER	CIRCUIT	SYMBOL	TEST CONDITONS	MIN	TYP	MAX	UNIT
Output Voltage	1	$V_{OUT(E)}$ (Note2)	$I_{OUT}=40mA, V_{IN}=5.5V$	4.410	4.500	4.59	V
Maximum Output Current	1	$I_{OUT(MAX)}$	$V_{IN}=5.5V, V_{OUT(E)}\geq 4.05V$	200			mA
Minimum Load Current		$I_{OUT(MIN)}$	$V_{IN}=V_{OUT}+1V$			50	μA
Load Stability	1	ΔV_{OUT}	$V_{IN}=5.5V, 1mA\leq I_{OUT}\leq 100mA$		45	90	mV
Input-Output Voltage Differential(Note3)	1	V_{DIF1}	$I_{OUT}=100mA$		170		mV
	1	V_{DIF2}	$I_{OUT}=200mA$		400		mV
Supply Current	2	I_{SS}	$V_{IN}=5.5V$		2.0	4.5	μA
Input Stability	1	$\frac{\Delta V_{OUT}}{\Delta V_{IN} \times V_{OUT}}$	$I_{OUT}=40mA$ $5.5V\leq V_{IN}\leq 10V$		0.2	0.3	%/V
Input Voltage		V_{IN}	$I_{OUT}=5mA$			10	V
Output Voltage Temperature Characteristics	1	$\frac{\Delta V_{OUT}}{\Delta T_{OPR} \times V_{OUT}}$	$I_{OUT}=40mA$ $-40^{\circ}C\leq T_{OPR}\leq 85^{\circ}C$		± 100		ppm/ $^{\circ}C$

UR6225-4.0V (Note1)

PARAMETER	CIRCUIT	SYMBOL	TEST CONDITONS	MIN	TYP	MAX	UNIT
Output Voltage	1	$V_{OUT(E)}$ (Note2)	$I_{OUT}=40mA, V_{IN}=5.0V$	3.920	4.000	4.080	V
Maximum Output Current	1	$I_{OUT(MAX)}$	$V_{IN}=5.0V, V_{OUT(E)}\geq 3.6V$	200			mA
Minimum Load Current		$I_{OUT(MIN)}$	$V_{IN}=V_{OUT}+1V$			50	μA
Load Stability	1	ΔV_{OUT}	$V_{IN}=5.0V, 1mA\leq I_{OUT}\leq 100mA$		45	90	mV
Input-Output Voltage Differential(Note3)	1	V_{DIF1}	$I_{OUT}=100mA$		170		mV
	1	V_{DIF2}	$I_{OUT}=200mA$		400		mV
Supply Current	2	I_{SS}	$V_{IN}=5.0V$		2.0	4.5	μA
Input Stability	1	$\frac{\Delta V_{OUT}}{\Delta V_{IN} \times V_{OUT}}$	$I_{OUT}=40mA$ $5.0V\leq V_{IN}\leq 10V$		0.2	0.3	%/V
Input Voltage		V_{IN}	$I_{OUT}=5mA$			10	V
Output Voltage Temperature Characteristics	1	$\frac{\Delta V_{OUT}}{\Delta T_{OPR} \times V_{OUT}}$	$I_{OUT}=40mA$ $-40^{\circ}C\leq T_{OPR}\leq 85^{\circ}C$		± 100		ppm/ $^{\circ}C$

UR6225-3.8V (Note1)

PARAMETER	CIRCUIT	SYMBOL	TEST CONDITONS	MIN	TYP	MAX	UNIT
Output Voltage	1	$V_{OUT(E)}$ (Note2)	$I_{OUT}=40mA, V_{IN}=4.8V$	3.724	3.800	3.876	V
Maximum Output Current	1	$I_{OUT(MAX)}$	$V_{IN}=4.8V, V_{OUT(E)}\geq 3.42V$	165			mA
Minimum Load Current		$I_{OUT(MIN)}$	$V_{IN}=V_{OUT}+1V$			50	μA
Load Stability	1	ΔV_{OUT}	$V_{IN}=4.8V, 1mA\leq I_{OUT}\leq 86mA$		45	90	mV
Input-Output Voltage Differential(Note3)	1	V_{DIF1}	$I_{OUT}=86mA$		180		mV
	1	V_{DIF2}	$I_{OUT}=172mA$		400		mV
Supply Current	2	I_{SS}	$V_{IN}=4.8V$		2.0	4.5	μA
Input Stability	1	$\frac{\Delta V_{OUT}}{\Delta V_{IN} \times V_{OUT}}$	$I_{OUT}=40mA$ $4.8V\leq V_{IN}\leq 10V$		0.2	0.3	%/V
Input Voltage		V_{IN}	$I_{OUT}=5mA$			10	V
Output Voltage Temperature Characteristics	1	$\frac{\Delta V_{OUT}}{\Delta T_{OPR} \times V_{OUT}}$	$I_{OUT}=40mA$ $-40^{\circ}C\leq T_{OPR}\leq 85^{\circ}C$		± 100		ppm/ $^{\circ}C$

■ ELECTRICAL CHARACTERISTICS (Cont.)

UR6225-3.6V (Note1)

PARAMETER	CIRCUIT	SYMBOL	TEST CONDITONS	MIN	TYP	MAX	UNIT
Output Voltage	1	$V_{OUT(E)}$ (Note2)	$I_{OUT}=40mA, V_{IN}=4.6V$	3.528	3.600	3.672	V
Maximum Output Current	1	$I_{OUT(MAX)}$	$V_{IN}=4.6V, V_{OUT(E)}\geq 3.24V$	165			mA
Minimum Load Current		$I_{OUT(MIN)}$	$V_{IN}=V_{OUT}+1V$			50	μA
Load Stability	1	ΔV_{OUT}	$V_{IN}=4.6V, 1mA\leq I_{OUT}\leq 86mA$		45	90	mV
Input-Output Voltage Differential(Note3)	1	V_{DIF1}	$I_{OUT}=86mA$		180		mV
	1	V_{DIF2}	$I_{OUT}=172mA$		400		mV
Supply Current	2	I_{SS}	$V_{IN}=4.6V$		2.0	4.5	μA
Input Stability	1	$\frac{\Delta V_{OUT}}{\Delta V_{IN} \times V_{OUT}}$	$I_{OUT}=40mA$ $4.6V\leq V_{IN}\leq 10V$		0.2	0.3	%/V
Input Voltage		V_{IN}	$I_{OUT}=5mA$			10	V
Output Voltage Temperature Characteristics	1	$\frac{\Delta V_{OUT}}{\Delta T_{OPR} \times V_{OUT}}$	$I_{OUT}=40mA$ $-40^{\circ}C\leq T_{OPR}\leq 85^{\circ}C$		± 100		ppm/ $^{\circ}C$

UR6225-3.5V (Note1)

PARAMETER	CIRCUIT	SYMBOL	TEST CONDITONS	MIN	TYP	MAX	UNIT
Output Voltage	1	$V_{OUT(E)}$ (Note2)	$I_{OUT}=40mA, V_{IN}=4.5V$	3.430	3.500	3.570	V
Maximum Output Current	1	$I_{OUT(MAX)}$	$V_{IN}=4.5V, V_{OUT(E)}\geq 3.15V$	165			mA
Minimum Load Current		$I_{OUT(MIN)}$	$V_{IN}=V_{OUT}+1V$			50	μA
Load Stability	1	ΔV_{OUT}	$V_{IN}=4.5V, 1mA\leq I_{OUT}\leq 86mA$		45	90	mV
Input-Output Voltage Differential(Note3)	1	V_{DIF1}	$I_{OUT}=86mA$		180		mV
	1	V_{DIF2}	$I_{OUT}=172mA$		400		mV
Supply Current	2	I_{SS}	$V_{IN}=4.5V$		2.0	4.5	μA
Input Stability	1	$\frac{\Delta V_{OUT}}{\Delta V_{IN} \times V_{OUT}}$	$I_{OUT}=40mA$ $4.5V\leq V_{IN}\leq 10V$		0.2	0.3	%/V
Input Voltage		V_{IN}	$I_{OUT}=5mA$			10	V
Output Voltage Temperature Characteristics	1	$\frac{\Delta V_{OUT}}{\Delta T_{OPR} \times V_{OUT}}$	$I_{OUT}=40mA$ $-40^{\circ}C\leq T_{OPR}\leq 85^{\circ}C$		± 100		ppm/ $^{\circ}C$

UR6225-3.3V (Note1)

PARAMETER	CIRCUIT	SYMBOL	TEST CONDITONS	MIN	TYP	MAX	UNIT
Output Voltage	1	$V_{OUT(E)}$ (Note2)	$I_{OUT}=40mA, V_{IN}=4.3V$	3.234	3.300	3.366	V
Maximum Output Current	1	$I_{OUT(MAX)}$	$V_{IN}=4.3V, V_{OUT(E)}\geq 2.97V$	165			mA
Minimum Load Current		$I_{OUT(MIN)}$	$V_{IN}=V_{OUT}+1V$			50	μA
Load Stability	1	ΔV_{OUT}	$V_{IN}=4.3V, 1mA\leq I_{OUT}\leq 86mA$		45	90	mV
Input-Output Voltage Differential(Note3)	1	V_{DIF1}	$I_{OUT}=86mA$		180		mV
	1	V_{DIF2}	$I_{OUT}=172mA$		400		mV
Supply Current	2	I_{SS}	$V_{IN}=4.3V$		2.0	4.5	μA
Input Stability	1	$\frac{\Delta V_{OUT}}{\Delta V_{IN} \times V_{OUT}}$	$I_{OUT}=40mA$ $4.3V\leq V_{IN}\leq 10V$		0.2	0.3	%/V
Input Voltage		V_{IN}	$I_{OUT}=5mA$			10	V
Output Voltage Temperature Characteristics	1	$\frac{\Delta V_{OUT}}{\Delta T_{OPR} \times V_{OUT}}$	$I_{OUT}=40mA$ $-40^{\circ}C\leq T_{OPR}\leq 85^{\circ}C$		± 100		ppm/ $^{\circ}C$

■ ELECTRICAL CHARACTERISTICS (Cont.)

UR6225-3.0V (Note1)

PARAMETER	CIRCUIT	SYMBOL	TEST CONDITONS	MIN	TYP	MAX	UNIT
Output Voltage	1	$V_{OUT(E)}$ (Note2)	$I_{OUT}=40mA, V_{IN}=4.0V$	2.940	3.000	3.060	V
Maximum Output Current	1	$I_{OUT(MAX)}$	$V_{IN}=4.0V, V_{OUT(E)} \geq 2.7V$	150			mA
Minimum Load Current		$I_{OUT(MIN)}$	$V_{IN}=V_{OUT}+1V$			50	μA
Load Stability	1	ΔV_{OUT}	$V_{IN}=4.0V, 1mA \leq I_{OUT} \leq 80mA$		45	90	mV
Input-Output Voltage Differential(Note3)	1	V_{DIF1}	$I_{OUT}=80mA$		180		mV
	1	V_{DIF2}	$I_{OUT}=160mA$		400		mV
Supply Current	2	I_{SS}	$V_{IN}=4.0V$		2.0	4.5	μA
Input Stability	1	$\frac{\Delta V_{OUT}}{\Delta V_{IN} \times V_{OUT}}$	$I_{OUT}=40mA$ $4.0V \leq V_{IN} \leq 10V$		0.2	0.3	%/V
Input Voltage		V_{IN}	$I_{OUT}=5mA$			10	V
Output Voltage Temperature Characteristics	1	$\frac{\Delta V_{OUT}}{\Delta T_{OPR} \times V_{OUT}}$	$I_{OUT}=40mA$ $-40^{\circ}C \leq T_{OPR} \leq 85^{\circ}C$		± 100		ppm/ $^{\circ}C$

UR6225-3.1V (Note1)

PARAMETER	CIRCUIT	SYMBOL	TEST CONDITONS	MIN	TYP	MAX	UNIT
Output Voltage	1	$V_{OUT(E)}$ (Note2)	$I_{OUT}=40mA, V_{IN}=4.0V$	3.038	3.1	3.162	V
Maximum Output Current	1	$I_{OUT(MAX)}$	$V_{IN}=4.0V, V_{OUT(E)} \geq 2.7V$	150			mA
Minimum Load Current		$I_{OUT(MIN)}$	$V_{IN}=V_{OUT}+1V$			50	μA
Load Stability	1	ΔV_{OUT}	$V_{IN}=4.0V, 1mA \leq I_{OUT} \leq 80mA$		45	90	mV
Input-Output Voltage Differential(Note3)	1	V_{DIF1}	$I_{OUT}=80mA$		180		mV
	1	V_{DIF2}	$I_{OUT}=160mA$		400		mV
Supply Current	2	I_{SS}	$V_{IN}=4.0V$		2.0	4.5	μA
Input Stability	1	$\frac{\Delta V_{OUT}}{\Delta V_{IN} \times V_{OUT}}$	$I_{OUT}=40mA$ $4.0V \leq V_{IN} \leq 10V$		0.2	0.3	%/V
Input Voltage		V_{IN}	$I_{OUT}=5mA$			10	V
Output Voltage Temperature Characteristics	1	$\frac{\Delta V_{OUT}}{\Delta T_{OPR} \times V_{OUT}}$	$I_{OUT}=40mA$ $-40^{\circ}C \leq T_{OPR} \leq 85^{\circ}C$		± 100		ppm/ $^{\circ}C$

UR6225-2.85V (Note1)

PARAMETER	CIRCUIT	SYMBOL	TEST CONDITONS	MIN	TYP	MAX	UNIT
Output Voltage	1	$V_{OUT(E)}$ (Note2)	$I_{OUT}=40mA, V_{IN}=3.85V$	2.793	2.850	2.907	V
Maximum Output Current	1	$I_{OUT(MAX)}$	$V_{IN}=3.85V, V_{OUT(E)} \geq 2.565V$	150			mA
Minimum Load Current		$I_{OUT(MIN)}$	$V_{IN}=V_{OUT}+1V$			50	μA
Load Stability	1	ΔV_{OUT}	$V_{IN}=3.85V, 1mA \leq I_{OUT} \leq 77mA$		45	90	mV
Input-Output Voltage Differential(Note3)	1	V_{DIF1}	$I_{OUT}=77mA$		180		mV
	1	V_{DIF2}	$I_{OUT}=154mA$		400		mV
Supply Current	2	I_{SS}	$V_{IN}=3.85V$		2.0	4.5	μA
Input Stability	1	$\frac{\Delta V_{OUT}}{\Delta V_{IN} \times V_{OUT}}$	$I_{OUT}=40mA$ $3.85V \leq V_{IN} \leq 10V$		0.2	0.3	%/V
Input Voltage		V_{IN}	$I_{OUT}=5mA$			10	V
Output Voltage Temperature Characteristics	1	$\frac{\Delta V_{OUT}}{\Delta T_{OPR} \times V_{OUT}}$	$I_{OUT}=40mA$ $-40^{\circ}C \leq T_{OPR} \leq 85^{\circ}C$		± 100		ppm/ $^{\circ}C$

■ ELECTRICAL CHARACTERISTICS (Cont.)

UR6225-2.8V (Note1)

PARAMETER	CIRCUIT	SYMBOL	TEST CONDITONS	MIN	TYP	MAX	UNIT
Output Voltage	1	$V_{OUT(E)}$ (Note2)	$I_{OUT}=40mA, V_{IN}=3.8V$	2.744	2.800	2.856	V
Maximum Output Current	1	$I_{OUT(MAX)}$	$V_{IN}=3.8V, V_{OUT(E)}\geq 2.52V$	150			mA
Minimum Load Current		$I_{OUT(MIN)}$	$V_{IN}=V_{OUT}+1V$			50	μA
Load Stability	1	ΔV_{OUT}	$V_{IN}=3.8V, 1mA\leq I_{OUT}\leq 76mA$		45	90	mV
Input-Output Voltage	1	V_{DIF1}	$I_{OUT}=76mA$		180		mV
Differential(Note3)	1	V_{DIF2}	$I_{OUT}=152mA$		400		mV
Supply Current	2	I_{SS}	$V_{IN}=3.8V$		2.0	4.5	μA
Input Stability	1	$\frac{\Delta V_{OUT}}{\Delta V_{IN} \times V_{OUT}}$	$I_{OUT}=40mA$ $3.8V\leq V_{IN}\leq 10V$		0.2	0.3	%/V
Input Voltage		V_{IN}	$I_{OUT}=5mA$			10	V
Output Voltage Temperature Characteristics	1	$\frac{\Delta V_{OUT}}{\Delta T_{OPR} \times V_{OUT}}$	$I_{OUT}=40mA$ $-40^{\circ}C\leq T_{OPR}\leq 85^{\circ}C$		± 100		ppm/ $^{\circ}C$

UR6225-2.7V (Note1)

PARAMETER	CIRCUIT	SYMBOL	TEST CONDITONS	MIN	TYP	MAX	UNIT
Output Voltage	1	$V_{OUT(E)}$ (Note2)	$I_{OUT}=40mA, V_{IN}=3.7V$	2.646	2.700	2.754	V
Maximum Output Current	1	$I_{OUT(MAX)}$	$V_{IN}=3.7V, V_{OUT(E)}\geq 2.43V$	150			mA
Minimum Load Current		$I_{OUT(MIN)}$	$V_{IN}=V_{OUT}+1V$			50	μA
Load Stability	1	ΔV_{OUT}	$V_{IN}=3.7V, 1mA\leq I_{OUT}\leq 76mA$		45	90	mV
Input-Output Voltage	1	V_{DIF1}	$I_{OUT}=76mA$		180		mV
Differential(Note3)	1	V_{DIF2}	$I_{OUT}=152mA$		400		mV
Supply Current	2	I_{SS}	$V_{IN}=3.7V$		2.0	4.5	μA
Input Stability	1	$\frac{\Delta V_{OUT}}{\Delta V_{IN} \times V_{OUT}}$	$I_{OUT}=40mA$ $3.7V\leq V_{IN}\leq 10V$		0.2	0.3	%/V
Input Voltage		V_{IN}	$I_{OUT}=5mA$			10	V
Output Voltage Temperature Characteristics	1	$\frac{\Delta V_{OUT}}{\Delta T_{OPR} \times V_{OUT}}$	$I_{OUT}=40mA$ $-40^{\circ}C\leq T_{OPR}\leq 85^{\circ}C$		± 100		ppm/ $^{\circ}C$

UR6225-2.6V (Note1)

PARAMETER	CIRCUIT	SYMBOL	TEST CONDITONS	MIN	TYP	MAX	UNIT
Output Voltage	1	$V_{OUT(E)}$ (Note2)	$I_{OUT}=40mA, V_{IN}=3.6V$	2.548	2.600	2.652	V
Maximum Output Current	1	$I_{OUT(MAX)}$	$V_{IN}=3.6V, V_{OUT(E)}\geq 2.34V$	150			mA
Minimum Load Current		$I_{OUT(MIN)}$	$V_{IN}=V_{OUT}+1V$			50	μA
Load Stability	1	ΔV_{OUT}	$V_{IN}=3.6V, 1mA\leq I_{OUT}\leq 72mA$		45	90	mV
Input-Output Voltage	1	V_{DIF1}	$I_{OUT}=72mA$		180		mV
Differential(Note3)	1	V_{DIF2}	$I_{OUT}=144mA$		400		mV
Supply Current	2	I_{SS}	$V_{IN}=3.6V$		2.0	4.5	μA
Input Stability	1	$\frac{\Delta V_{OUT}}{\Delta V_{IN} \times V_{OUT}}$	$I_{OUT}=40mA$ $3.6V\leq V_{IN}\leq 10V$		0.2	0.3	%/V
Input Voltage		V_{IN}	$I_{OUT}=5mA$			10	V
Output Voltage Temperature Characteristics	1	$\frac{\Delta V_{OUT}}{\Delta T_{OPR} \times V_{OUT}}$	$I_{OUT}=40mA$ $-40^{\circ}C\leq T_{OPR}\leq 85^{\circ}C$		± 100		ppm/ $^{\circ}C$

■ ELECTRICAL CHARACTERISTICS (Cont.)

UR6225-2.5V (Note1)

PARAMETER	CIRCUIT	SYMBOL	TEST CONDITONS	MIN	TYP	MAX	UNIT
Output Voltage	1	$V_{OUT(E)}$ (Note2)	$I_{OUT}=40mA, V_{IN}=3.5V$	2.45	2.500	2.55	V
Maximum Output Current	1	$I_{OUT(MAX)}$	$V_{IN}=3.5V, V_{OUT(E)}\geq 2.25V$	125			mA
Minimum Load Current		$I_{OUT(MIN)}$	$V_{IN}=V_{OUT}+1V$			50	μA
Load Stability	1	ΔV_{OUT}	$V_{IN}=3.5V, 1mA\leq I_{OUT}\leq 70mA$		45	90	mV
Input-Output Voltage	1	V_{DIF1}	$I_{OUT}=70mA$		180		mV
Differential(Note3)	1	V_{DIF2}	$I_{OUT}=140mA$		400		mV
Supply Current	2	I_{SS}	$V_{IN}=3.5V$		2.0	4.5	μA
Input Stability	1	$\frac{\Delta V_{OUT}}{\Delta V_{IN} \times V_{OUT}}$	$I_{OUT}=40mA$ $3.5V\leq V_{IN}\leq 10V$		0.2	0.3	%/V
Input Voltage		V_{IN}	$I_{OUT}=5mA$			10	V
Output Voltage Temperature Characteristics	1	$\frac{\Delta V_{OUT}}{\Delta T_{OPR} \times V_{OUT}}$	$I_{OUT}=40mA$ $-40^{\circ}C\leq T_{OPR}\leq 85^{\circ}C$		± 100		ppm/ $^{\circ}C$

UR6225-2.1V (Note1)

PARAMETER	CIRCUIT	SYMBOL	TEST CONDITONS	MIN	TYP	MAX	UNIT
Output Voltage	1	$V_{OUT(E)}$ (Note2)	$I_{OUT}=40mA, V_{IN}=3.1V$	2.058	2.100	2.142	V
Maximum Output Current	1	$I_{OUT(MAX)}$	$V_{IN}=3.1V, V_{OUT(E)}\geq 1.89V$	125			mA
Minimum Load Current		$I_{OUT(MIN)}$	$V_{IN}=V_{OUT}+1V$			50	μA
Load Stability	1	ΔV_{OUT}	$V_{IN}=3.1V, 1mA\leq I_{OUT}\leq 62mA$		45	90	mV
Input-Output Voltage	1	V_{DIF1}	$I_{OUT}=62mA$		180		mV
Differential(Note3)	1	V_{DIF2}	$I_{OUT}=124mA$		400		mV
Supply Current	2	I_{SS}	$V_{IN}=3.1V$		2.0	4.5	μA
Input Stability	1	$\frac{\Delta V_{OUT}}{\Delta V_{IN} \times V_{OUT}}$	$I_{OUT}=40mA$ $3.1V\leq V_{IN}\leq 10V$		0.2	0.3	%/V
Input Voltage		V_{IN}	$I_{OUT}=5mA$			10	V
Output Voltage Temperature Characteristics	1	$\frac{\Delta V_{OUT}}{\Delta T_{OPR} \times V_{OUT}}$	$I_{OUT}=40mA$ $-40^{\circ}C\leq T_{OPR}\leq 85^{\circ}C$		± 100		ppm/ $^{\circ}C$

UR6225-2.0V (Note1)

PARAMETER	CIRCUIT	SYMBOL	TEST CONDITONS	MIN	TYP	MAX	UNIT
Output Voltage	1	$V_{OUT(E)}$ (Note2)	$I_{OUT}=40mA, V_{IN}=3.0V$	1.960	2.000	2.040	V
Maximum Output Current	1	$I_{OUT(MAX)}$	$V_{IN}=3.0V, V_{OUT(E)}\geq 1.8V$	100			mA
Minimum Load Current		$I_{OUT(MIN)}$	$V_{IN}=V_{OUT}+1V$			50	μA
Load Stability	1	ΔV_{OUT}	$V_{IN}=3.0V, 1mA\leq I_{OUT}\leq 60mA$		45	90	mV
Input-Output Voltage	1	V_{DIF1}	$I_{OUT}=60mA$		180		mV
Differential(Note3)	1	V_{DIF2}	$I_{OUT}=120mA$		400		mV
Supply Current	2	I_{SS}	$V_{IN}=3.0V$		2.0	4.5	μA
Input Stability	1	$\frac{\Delta V_{OUT}}{\Delta V_{IN} \times V_{OUT}}$	$I_{OUT}=40mA$ $3.0V\leq V_{IN}\leq 10V$		0.2	0.3	%/V
Input Voltage		V_{IN}	$I_{OUT}=5mA$			10	V
Output Voltage Temperature Characteristics	1	$\frac{\Delta V_{OUT}}{\Delta T_{OPR} \times V_{OUT}}$	$I_{OUT}=40mA$ $-40^{\circ}C\leq T_{OPR}\leq 85^{\circ}C$		± 100		ppm/ $^{\circ}C$

■ ELECTRICAL CHARACTERISTICS(Cont.)

UR6225-1.8V (Note1)

PARAMETER	CIRCUIT	SYMBOL	TEST CONDITONS	MIN	TYP	MAX	UNIT
Output Voltage	1	$V_{OUT(E)}$ (Note2)	$I_{OUT}=40mA, V_{IN}=2.8V$	1.764	1.800	1.836	V
Maximum Output Current	1	$I_{OUT(MAX)}$	$V_{IN}=2.8V, V_{OUT(E)}\geq 1.62V$	100			mA
Minimum Load Current		$I_{OUT(MIN)}$	$V_{IN}=V_{OUT}+1V$			50	μA
Load Stability	1	ΔV_{OUT}	$V_{IN}=2.8V, 1mA\leq I_{OUT}\leq 60mA$		45	90	mV
Input-Output Voltage	1	V_{DIF1}	$I_{OUT}=56mA$		400		mV
Differential(Note3)	1	V_{DIF2}	$I_{OUT}=112mA$		600		mV
Supply Current	2	I_{SS}	$V_{IN}=2.8V$		2.0	4.5	μA
Input Stability	1	$\frac{\Delta V_{OUT}}{\Delta V_{IN} \times V_{OUT}}$	$I_{OUT}=40mA$ $2.8V\leq V_{IN}\leq 10V$		0.2	0.3	%/V
Input Voltage		V_{IN}	$I_{OUT}=5mA$			10	V
Output Voltage Temperature Characteristics	1	$\frac{\Delta V_{OUT}}{\Delta T_{OPR} \times V_{OUT}}$	$I_{OUT}=40mA$ $-40^{\circ}C\leq T_{OPR}\leq 85^{\circ}C$		± 100		ppm/ $^{\circ}C$

UR6225-1.5V (Note1)

PARAMETER	CIRCUIT	SYMBOL	TEST CONDITONS	MIN	TYP	MAX	UNIT
Output Voltage	1	$V_{OUT(E)}$ (Note2)	$I_{OUT}=40mA$	1.470	1.500	1.530	V
Maximum Output Current	1	$I_{OUT(MAX)}$	$V_{IN}=2.5V, V_{OUT(E)}\geq 1.35V$	100			mA
Minimum Load Current		$I_{OUT(MIN)}$	$V_{IN}=V_{OUT}+1V$			50	μA
Load Stability	1	ΔV_{OUT}	$V_{IN}=2.5V, 1mA\leq I_{OUT}\leq 60mA$		45	90	mV
Input-Output Voltage	1	V_{DIF1}	$I_{OUT}=56mA$		400		mV
Differential(Note3)	1	V_{DIF2}	$I_{OUT}=112mA$		600		mV
Supply Current	2	I_{SS}	$V_{IN}=2.5V$		2.0	4.5	μA
Input Stability	1	$\frac{\Delta V_{OUT}}{\Delta V_{IN} \times V_{OUT}}$	$I_{OUT}=40mA$ $2.5V\leq V_{IN}\leq 10V$		0.2	0.3	%/V
Input Voltage		V_{IN}	$I_{OUT}=5mA$			10	V
Output Voltage Temperature Characteristics	1	$\frac{\Delta V_{OUT}}{\Delta T_{OPR} \times V_{OUT}}$	$I_{OUT}=40mA$ $-40^{\circ}C\leq T_{OPR}\leq 85^{\circ}C$		± 100		ppm/ $^{\circ}C$

Notes: 1. $V_{OUT(T)}$ =Specified Output Voltage.

2. $V_{OUT(E)}$ =Effective Output Voltage (i.e. the output voltage when " $V_{OUT(T)}+1.0V$ " is provided at the V_{IN} pin while maintaining a certain I_{OUT} value).

3. $V_{DIF} = \{V_{IN1}^{(Note4)} - V_{OUT(E)}\}$

4. V_{IN1} = The input voltage at the time 98% of $V_{OUT(E)}$ is output (input voltage has been gradually reduced).

■ TEST CIRCUITS

Circuit 1

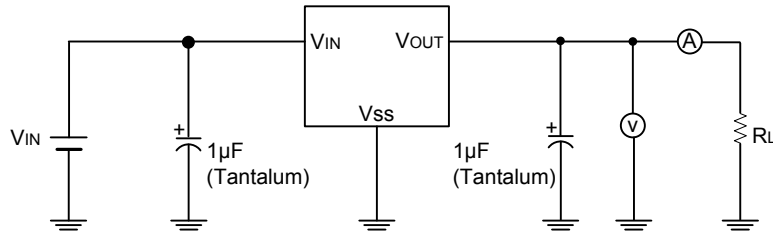

Circuit 2

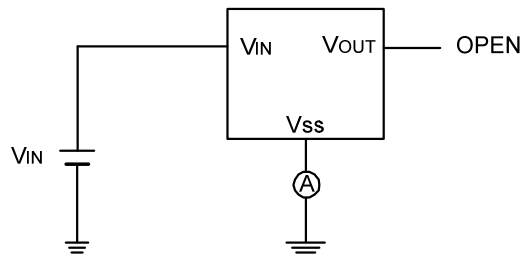

■ TYPICAL APPLICATION CIRCUIT

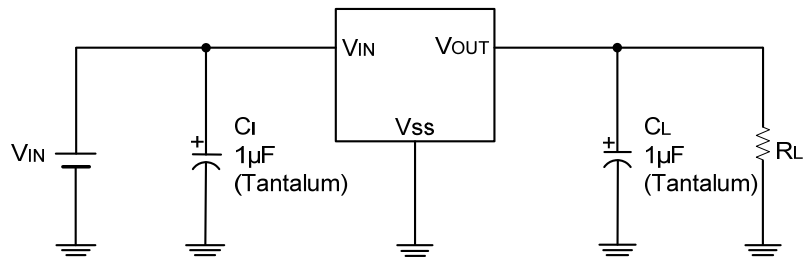

■ TYPICAL CHARACTERISTIC

(1) OUTPUT VOLTAGE VS. OUTPUT CURRENT

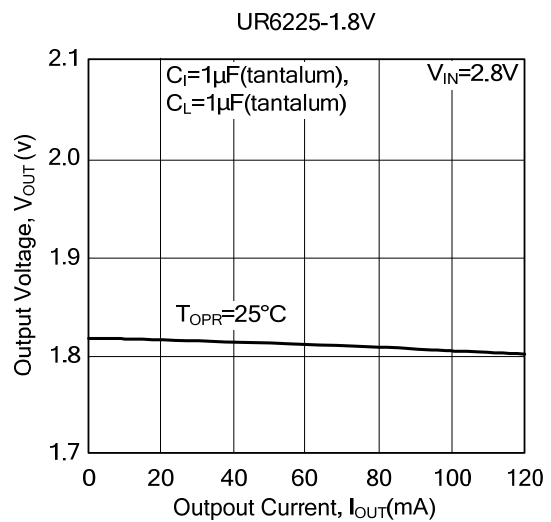
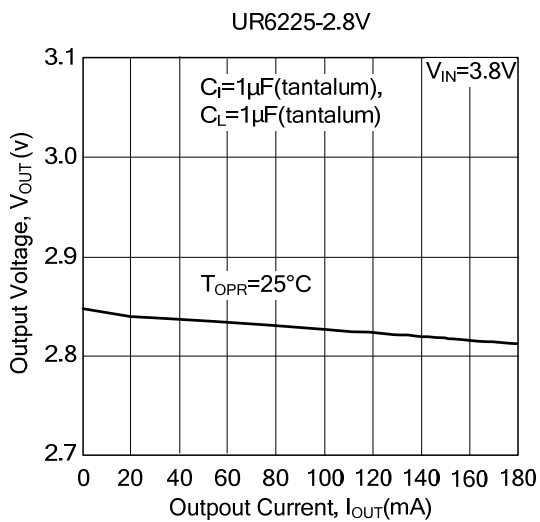
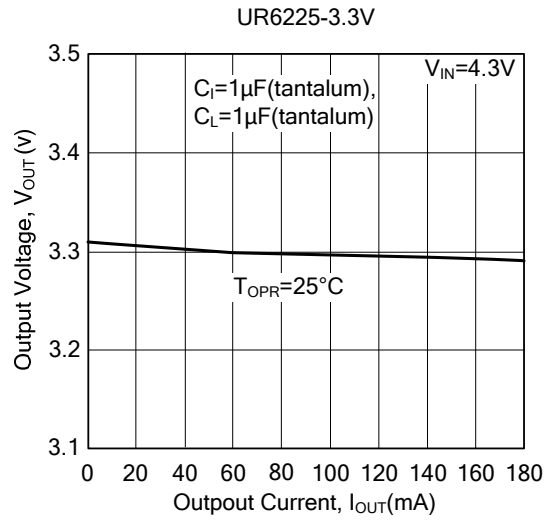
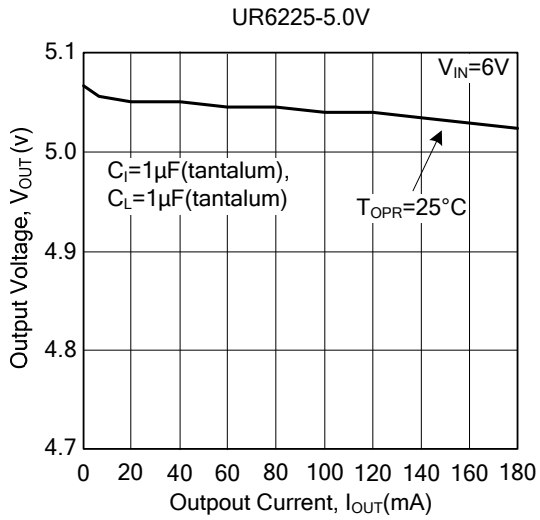

(2) OUTPUT VOLTAGE VS. INPUT VOLTAGE

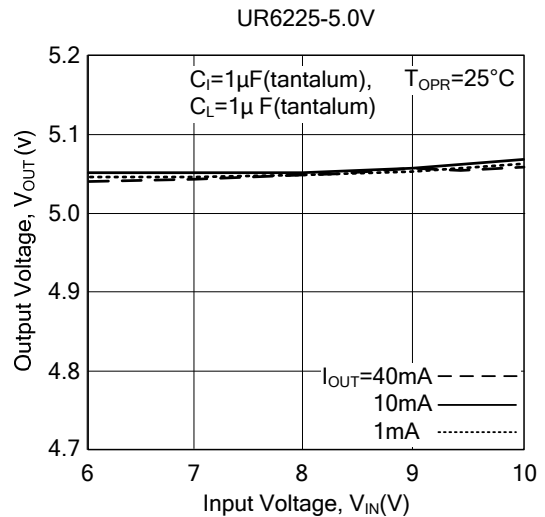
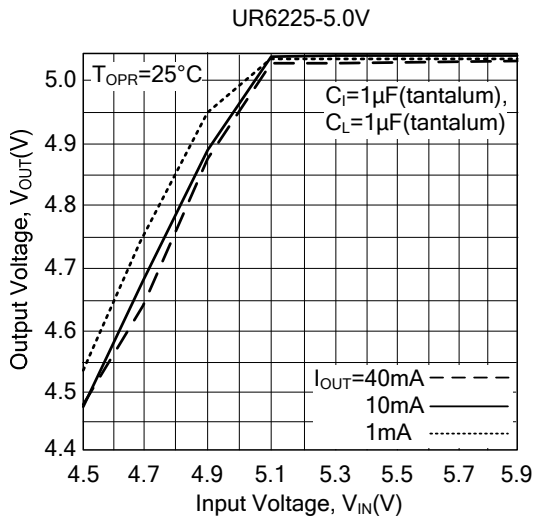

■ TYPICAL CHARACTERISTIC (Cont.)

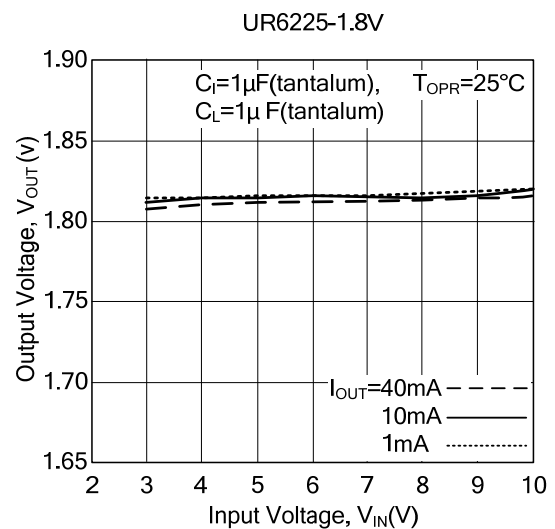
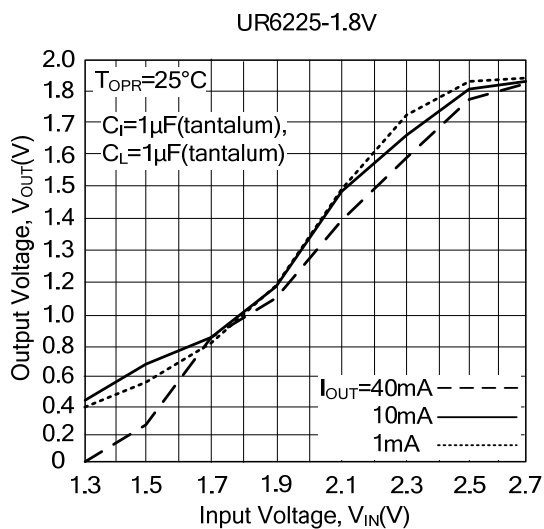
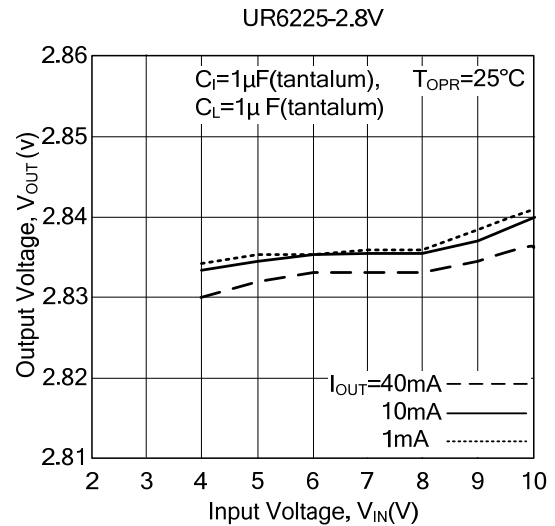
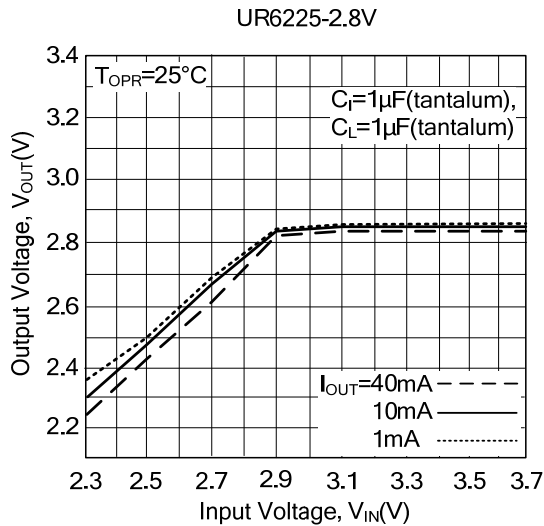
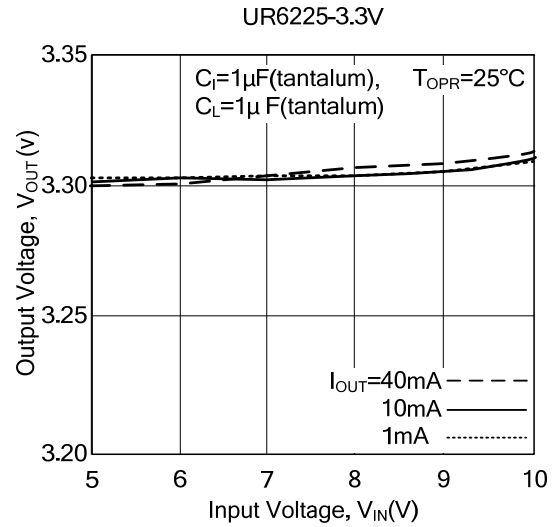
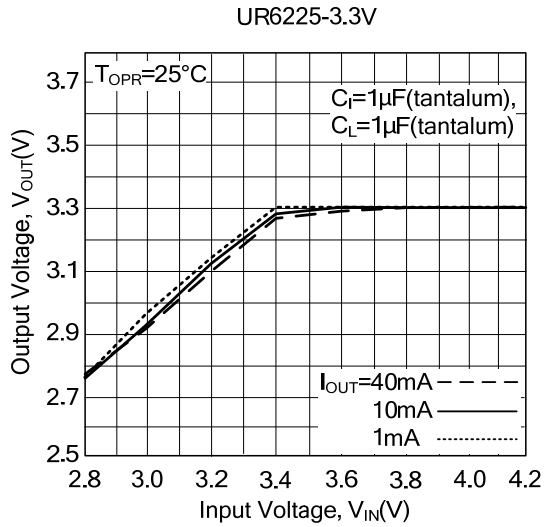

■ TYPICAL CHARACTERISTIC (Cont.)

(3) INPUT/OUTPUT VOLTAGE DIFFERENTIAL VS. OUTPUT CURRENT

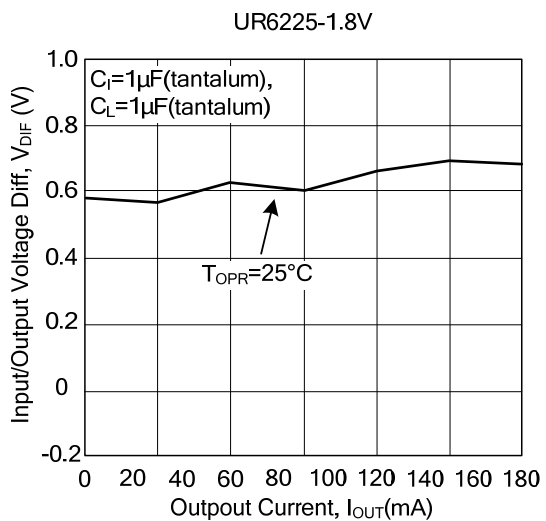
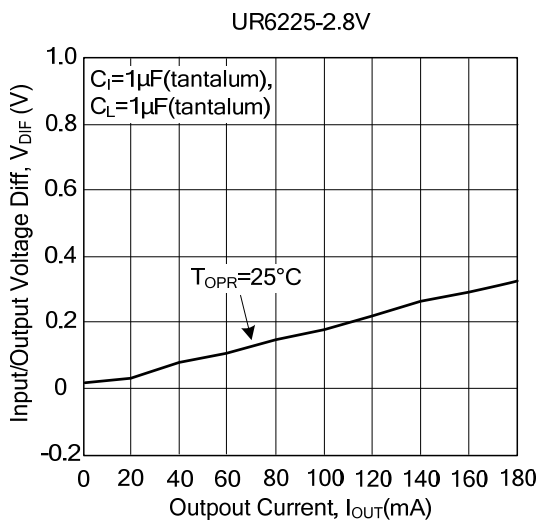
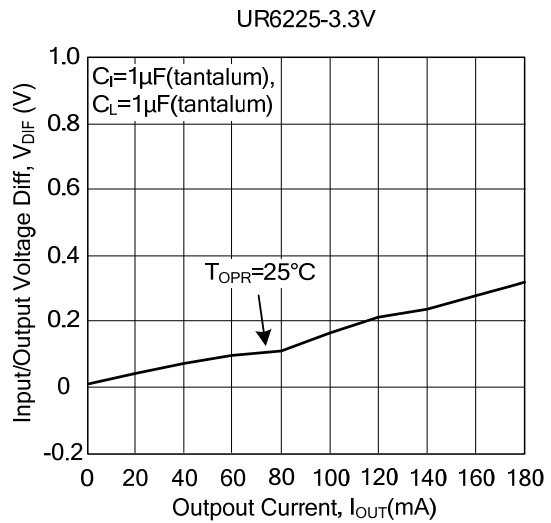
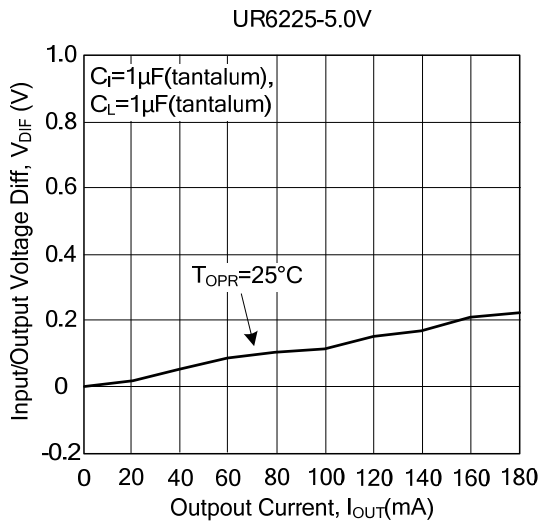

(4) SUPPLY CURRENT VS. INPUT VOLTAGE

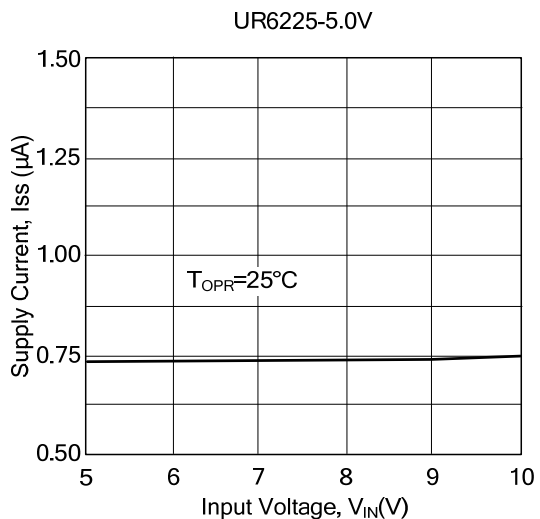
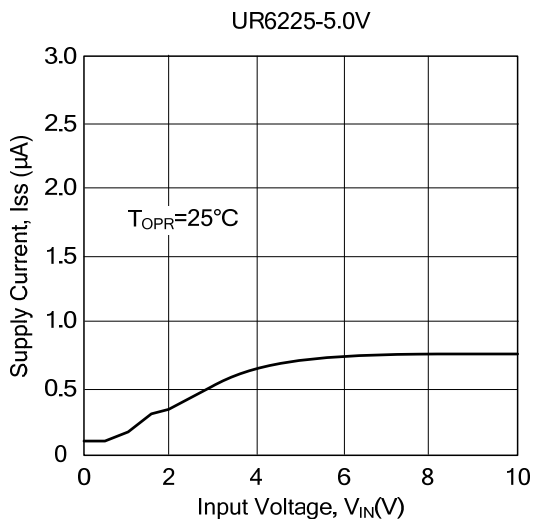

■ TYPICAL CHARACTERISTIC (Cont.)

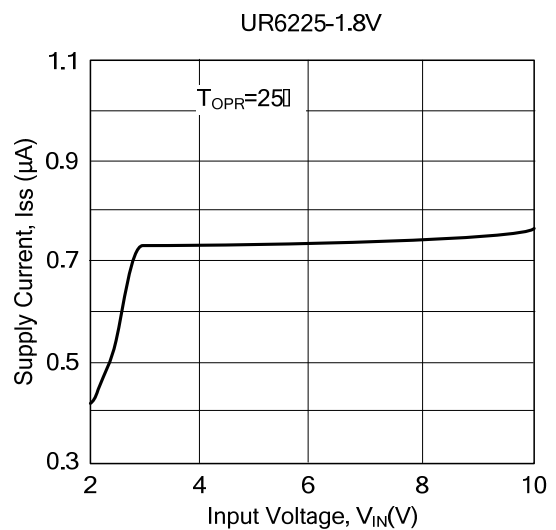
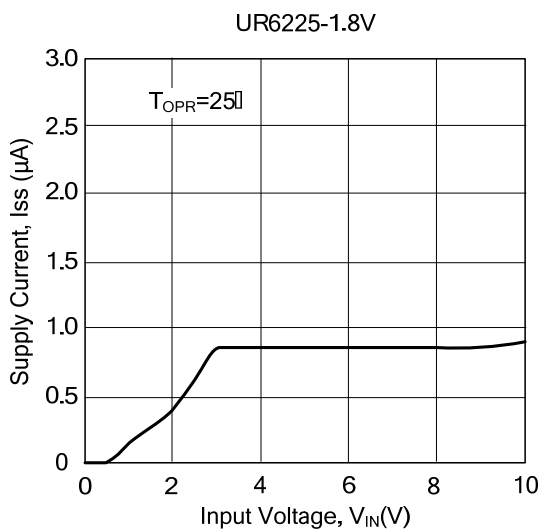
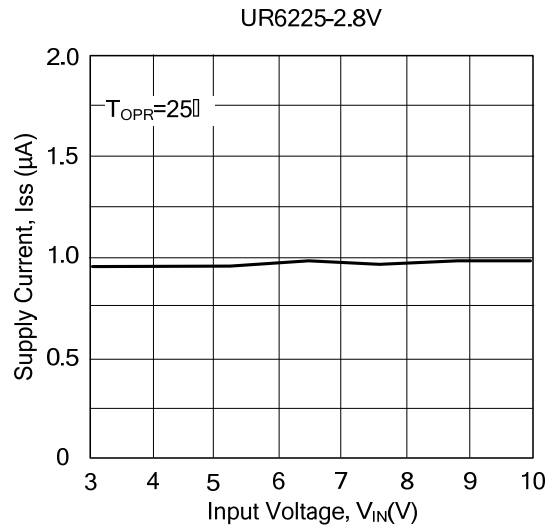
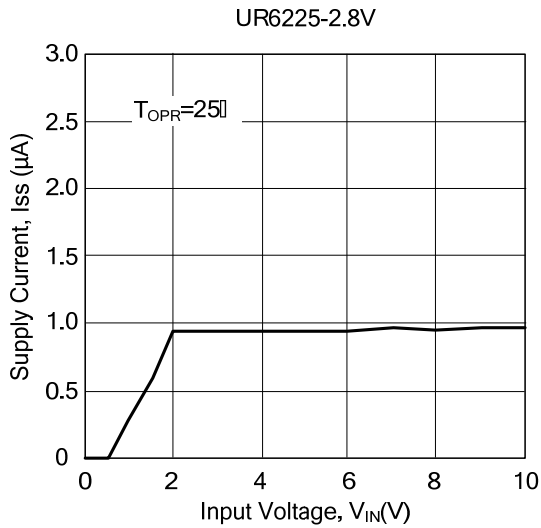
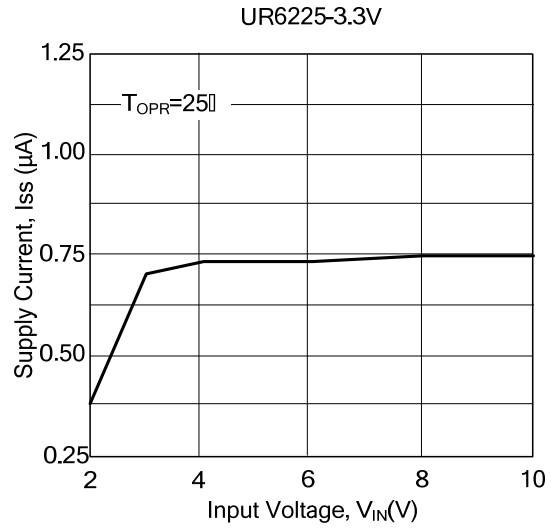
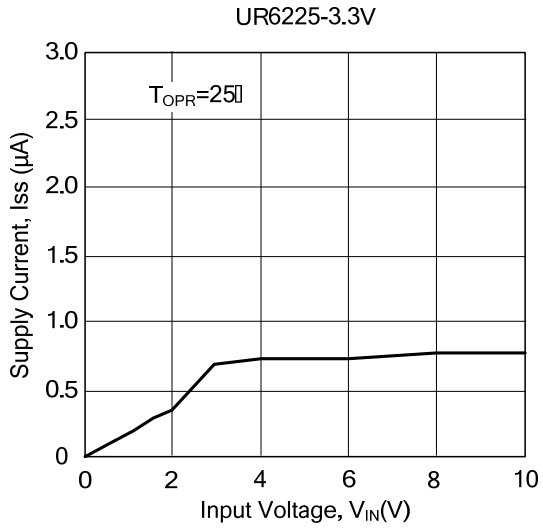

■ TYPICAL CHARACTERISTIC (Cont.)

(5) LOAD TRANSIENT RESPONSE

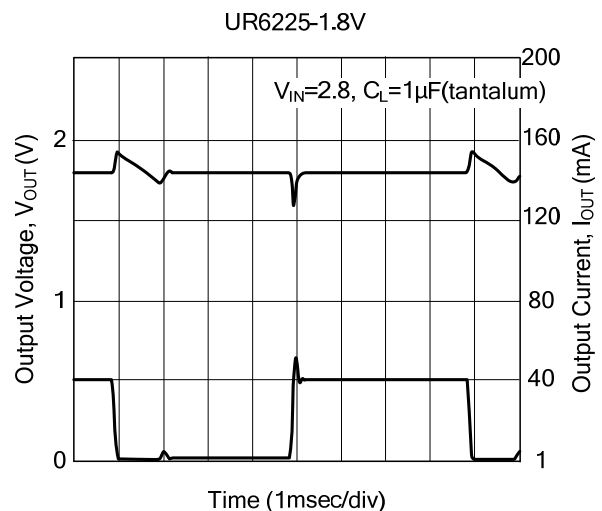
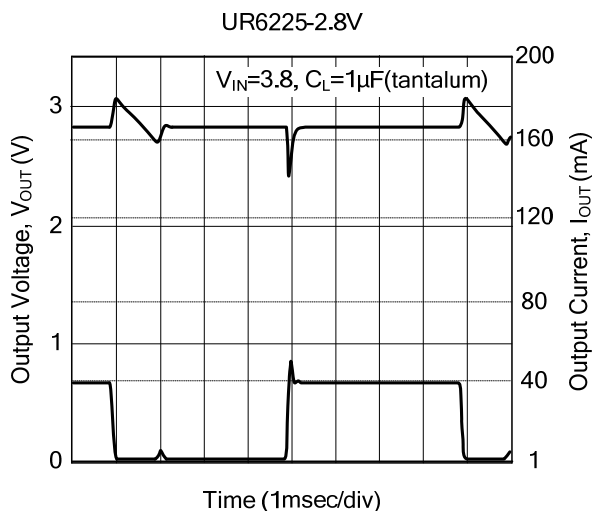
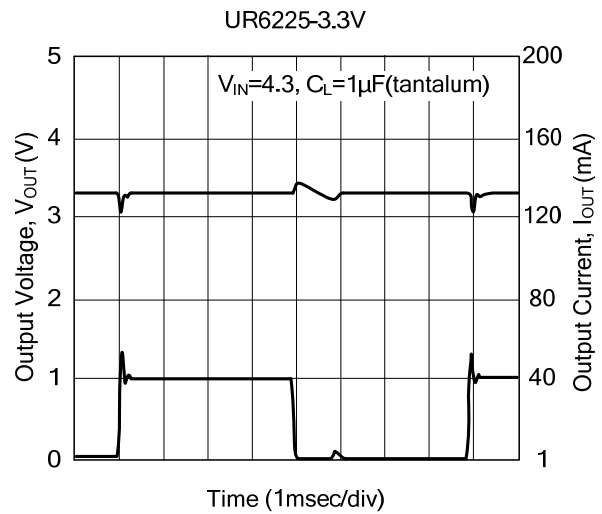
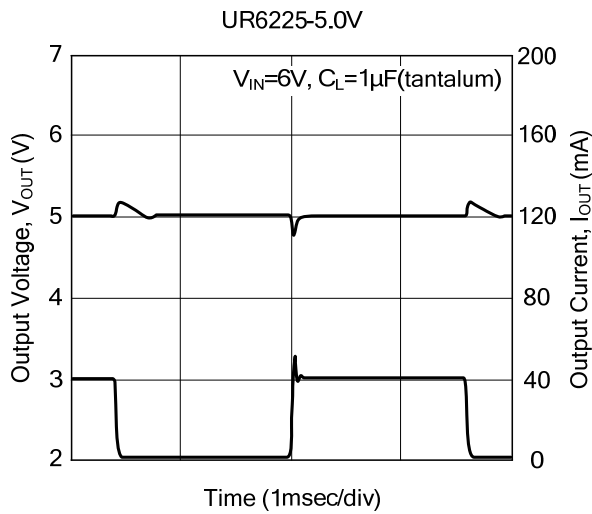

UTC assumes no responsibility for equipment failures that result from using products at values that exceed, even momentarily, rated values (such as maximum ratings, operating condition ranges, or other parameters) listed in products specifications of any and all UTC products described or contained herein. UTC products are not designed for use in life support appliances, devices or systems where malfunction of these products can be reasonably expected to result in personal injury. Reproduction in whole or in part is prohibited without the prior written consent of the copyright owner. UTC reserves the right to make changes to information published in this document, including without limitation specifications and product descriptions, at any time and without notice. This document supersedes and replaces all information supplied prior to the publication hereof.

X-ON Electronics

Largest Supplier of Electrical and Electronic Components

Click to view similar products for [unisonic](#) manufacturer:

Other Similar products are found below :

[UTT18P10L-TN3-R](#) [TIP31CL-TA3-T](#) [HJ44H11L-TA3-T](#) [78T05AL-TQ2-R](#) [UTT25P10L-TA3-T](#) [8N80L-TF1-T](#) [TDA2030AL-TB5-T](#)
[U74AC04G-S14-R](#) [5N60L-A-TF1-T](#) [MJE2955TL-TA3-T](#) [4N60L-TA3-T](#) [10N70L-TF2-T](#) [UP9971G-S08-R](#) [17P10L-TN3-R](#) [LM386L-D08-T](#)
[79D12AL-TN3-R](#) [LM339G-S14-R](#) [2SB649AG-C-AB3-R](#) [MBR40150CL-TA3-T](#) [MBR20200CL-TF1-T](#) [UR5512L-SO8-R](#) [TEA1110AL-D14-T](#)
[UZ1084L-33-TQ2-R](#) [LM7924L-TA3-T](#) [UZ1085L-ADJ-TA3-T](#) [U74HC164G-S14-R](#) [UZ1085L-18-TQ3-R](#) [10N65KL-TF3-T](#) [12N60L-TF2-T](#)
[2N60L-B-TF3-T](#) [14N50L-TQ2-R](#) [BTC1510F3L-TN3-R](#) [4N60KL-TF3-T](#) [MBR10100CL-TA3-T](#) [LM4863G-N20-R](#) [UTM4953G-SO8-R](#)
[10N60L-TF1-T](#) [U74HC165G-S16-R](#) [78D15](#) [9N90L-T3P-T](#) [MC34119L-D08-T](#) [UT9564G-SO8-R](#) [12N65KL-TF1-T](#) [7N60L-TF1-T](#)
[2SD1857L-Q-T92-B](#) [78L08G-AB3-R](#) [MC34118G-S28-R](#) [12N80L-FC TO-220F](#) [4N70KL-MT-TN3-R](#) [78L12L-T92-B](#)