



UT3N06

Power MOSFET

N-CHANNEL ENHANCEMENT MODE POWER MOSFET

■ DESCRIPTION

The UTC **UT3N06** is an N-channel power MOSFET providing very low on-resistance. It has high efficiency and perfect cost-effectiveness. It can be generally applied in the commercial and industrial fields.

■ FEATURES

* Simple drive requirement

■ SYMBOL

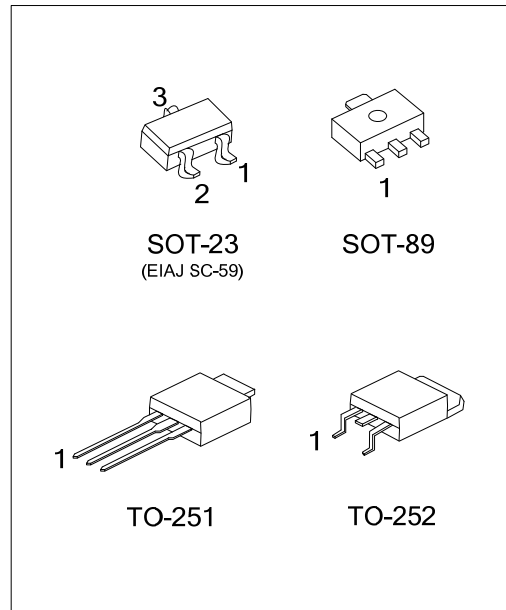
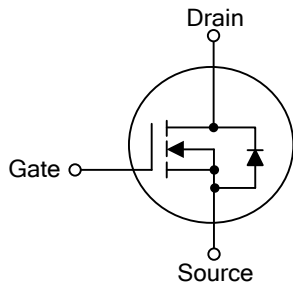

■ ORDERING INFORMATION

Ordering Number		Package	Pin Assignment			Packing
Lead Free	Halogen Free		1	2	3	
-	UT3N06G-AB3-R	SOT-89	G	D	S	Tape Reel
-	UT3N06G-AE3-R	SOT-23	S	G	D	Tape Reel
UT3N06L-TM3-T	UT3N06G-TM3-T	TO-251	G	D	S	Tube
UT3N06L-TN3-R	UT3N06G-TN3-R	TO-252	G	D	S	Tape Reel

Note: Pin Assignment: G: Gate D: Drain S: Source

<p>UT3N06G-AB3-R</p>	<p>(1) T: Tube, R: Tape Reel (2) AB3: SOT-89, AE3: SOT-23, TM3: TO-251 TN3: TO-252 (3) G: Halogen Free and Lead Free, L: Lead Free</p>
----------------------	-------------------------------------------------------------------------------------------------------------------------------------------------------------------------------------------------------

■ MARKING

SOT-89	SOT-23	TO-251 / TO-252

■ ABSOLUTE MAXIMUM RATINGS

PARAMETER	SYMBOL	RATINGS	UNIT
Drain-Source Voltage	V_{DSS}	60	V
Gate-Source Voltage	V_{GSS}	± 20	V
Continuous Drain Current ($V_{GS}=4.5V$, $T_A=25^\circ C$) (Note 2)	I_D	3.0	A
Pulsed Drain Current (Note 3, 4)	I_{DM}	10	A
Power Dissipation ($T_A=25^\circ C$)	SOT-23	0.35	W
	SOT-89	0.69	W
	TO-251/TO-252	1.13	W
Junction Temperature	T_J	+150	$^\circ C$
Storage Temperature	T_{STG}	-55 ~ +150	$^\circ C$

- Notes: 1. Absolute maximum ratings are those values beyond which the device could be permanently damaged. Absolute maximum ratings are stress ratings only and functional device operation is not implied.
 2. Surface mounted on 1 in² copper pad of FR4 board; 270 $^\circ C/W$ when mounted on min. copper pad
 3. Pulse width limited by $T_{J(MAX)}$
 4. Pulse width $\leq 300\mu s$, duty cycle $\leq 2\%$

■ THERMAL DATA

PARAMETER	SYMBOL	RATING	UNIT
Junction to Ambient	SOT-23	350	$^\circ C/W$
	SOT-89	180	$^\circ C/W$
	TO-251/TO-252	110	$^\circ C/W$

■ ELECTRICAL CHARACTERISTICS ($T_J = 25^\circ C$, unless otherwise specified)

PARAMETER	SYMBOL	TEST CONDITIONS	MIN	TYP	MAX	UNIT
OFF CHARACTERISTICS						
Drain-Source Breakdown Voltage	BV_{DSS}	$V_{GS}=0V$, $I_D=250\mu A$	60			V
Breakdown Voltage Temperature Coefficient	$\frac{\Delta BV_{DSS}}{\Delta T_J}$	Reference to $25^\circ C$, $I_D=1mA$		0.05		$V/^\circ C$
Drain-Source Leakage Current	I_{DSS}	$V_{DS}=60V$, $V_{GS}=0V$			10	μA
Gate-Source Leakage Current	I_{GSS}	$V_{GS}=\pm 20V$			± 100	nA
ON CHARACTERISTICS						
Gate Threshold Voltage	$V_{GS(TH)}$	$V_{DS}=V_{GS}$, $I_D=250\mu A$	1.0		3.0	V
Drain to Source On-state Resistance	$R_{DS(ON)}$	$V_{GS}=10V$, $I_D=3A$			90	m Ω
		$V_{GS}=4.5V$, $I_D=2A$			120	m Ω
DYNAMIC PARAMETERS						
Input Capacitance	C_{ISS}	$V_{DS}=25V$, $V_{GS}=0V$, $f=1.0MHz$		490	780	pF
Output Capacitance	C_{OSS}			55		pF
Reverse Transfer Capacitance	C_{RSS}			40		pF
SWITCHING PARAMETERS						
Turn-ON Delay Time (Note)	$t_{D(ON)}$	$V_{GS}=10V$, $V_{DS}=30V$, $I_D=1A$, $R_D=30\Omega$, $R_G=3.3\Omega$		6		ns
Turn-ON Rise Time	t_R			5	42	ns
Turn-OFF Delay Time	$t_{D(OFF)}$			16		ns
Turn-OFF Fall-Time	t_F			3	58	ns
Total Gate Charge (Note)	Q_G	$V_{GS}=4.5V$, $V_{DS}=48V$, $I_D=3A$		6	10	nC
Gate Source Charge	Q_{GS}			1.6		nC
Gate Drain Charge	Q_{GD}			3		nC
SOURCE- DRAIN DIODE RATINGS AND CHARACTERISTICS						
Drain-Source Diode Forward Voltage (Note)	V_{SD}	$I_S=1.2A$, $V_{GS}=0V$			1.2	V
Reverse Recovery Time	t_{rr}	$I_S=3A$, $V_{GS}=0V$, $dI/dt=100A/\mu s$		25		ns
Reverse Recovery Charge	Q_{RR}			26		nC

Note: Pulse width $\leq 300\mu s$, duty cycle $\leq 2\%$.

■ TEST WAVEFORMS

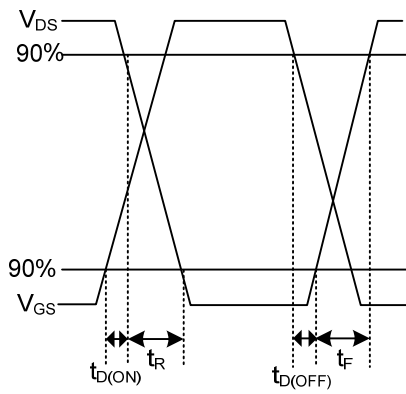

Switching Time Waveform

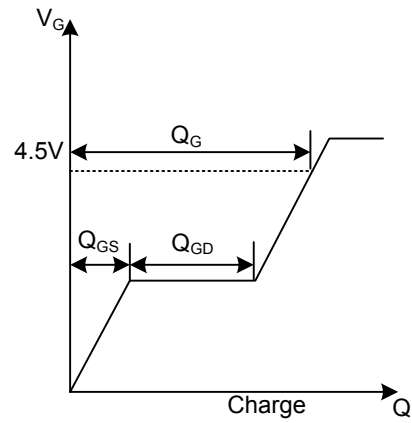

Gate Charge Waveform

■ TYPICAL CHARACTERISTICS

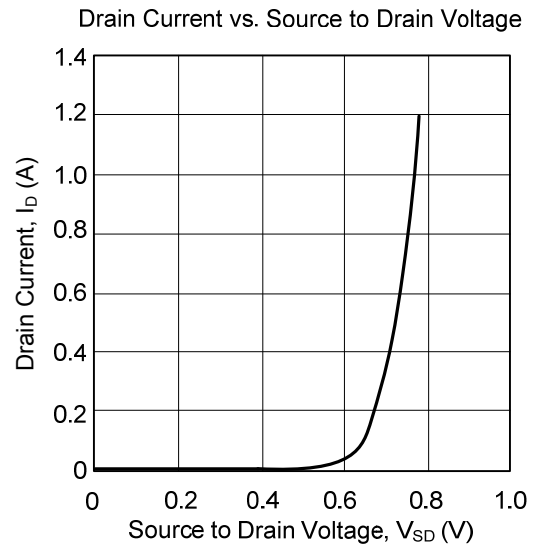
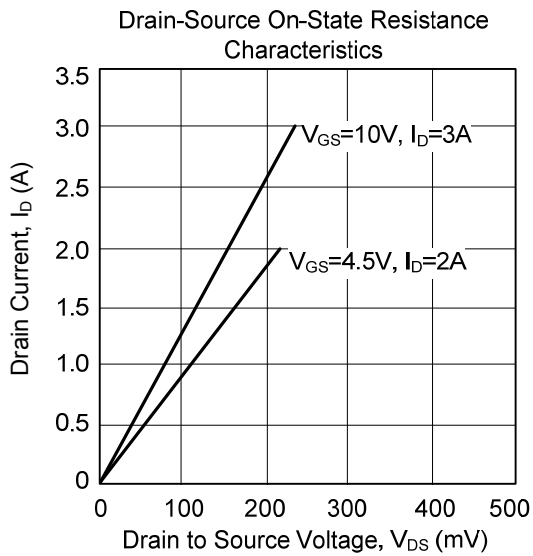
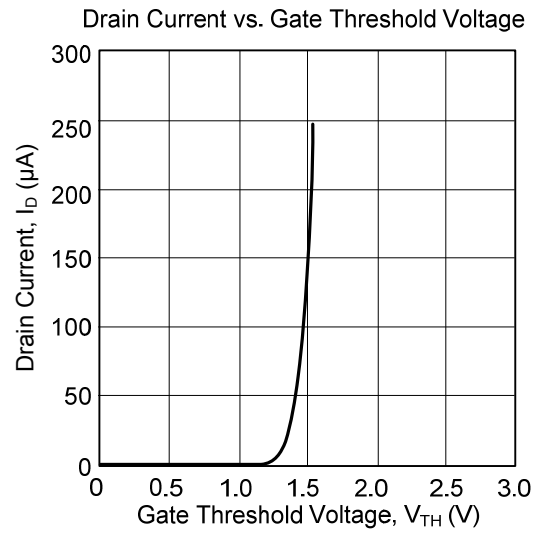
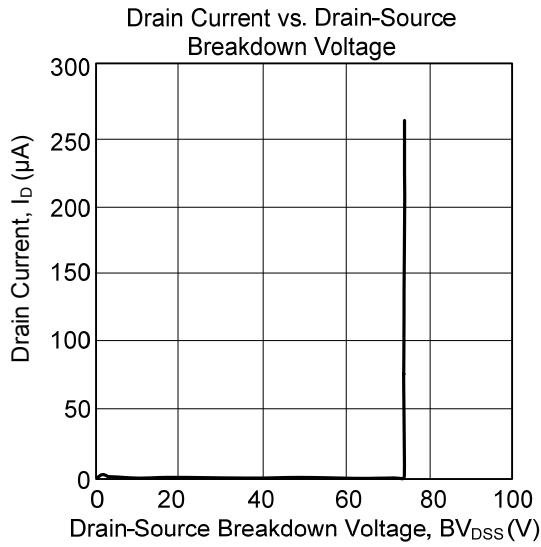

UTC assumes no responsibility for equipment failures that result from using products at values that exceed, even momentarily, rated values (such as maximum ratings, operating condition ranges, or other parameters) listed in products specifications of any and all UTC products described or contained herein. UTC products are not designed for use in life support appliances, devices or systems where malfunction of these products can be reasonably expected to result in personal injury. Reproduction in whole or in part is prohibited without the prior written consent of the copyright owner. The information presented in this document does not form part of any quotation or contract, is believed to be accurate and reliable and may be changed without notice.

X-ON Electronics

Largest Supplier of Electrical and Electronic Components

Click to view similar products for [MOSFET](#) category:

Click to view products by [Unisonic](#) manufacturer:

Other Similar products are found below :

[614233C](#) [648584F](#) [FDPF9N50NZ](#) [IRFD120](#) [IRFF430](#) [JANTX2N5237](#) [2N7000](#) [FCA20N60_F109](#) [FDZ595PZ](#) [2SK2267\(Q\)](#) [2SK2545\(Q,T\)](#)
[405094E](#) [423220D](#) [MIC4420CM-TR](#) [VN1206L](#) [614234A](#) [715780A](#) [SSM6J414TU,LF\(T](#) [751625C](#) [PSMN4R2-30MLD](#)
[TK31J60W5,S1VQ\(O](#) [2SK2614\(TE16L1,Q\)](#) [DMN1017UCP3-7](#) [EFC2J004NUZTDG](#) [FCAB21350L1](#) [P85W28HP2F-7071](#) [DMN1053UCP4-7](#)
[NTE2384](#) [NTE2969](#) [NTE6400A](#) [DMN61D9UWQ-13](#) [US6M2GTR](#) [DMN31D5UDJ-7](#) [SSM6P54TU,LF](#) [DMP22D4UFO-7B](#)
[IPS60R3K4CEAKMA1](#) [DMN1006UCA6-7](#) [DMN16M9UCA6-7](#) [STF5N65M6](#) [STU5N65M6](#) [C3M0021120D](#) [DMN13M9UCA6-7](#)
[BSS340NWH6327XTSA1](#) [MCM3400A-TP](#) [DMTH10H4M6SPS-13](#) [IPS60R1K0PFD7SAKMA1](#) [IPS60R360PFD7SAKMA1](#)
[IPS60R600PFD7SAKMA1](#) [IPS60R210PFD7SAKMA1](#) [DMN2990UFB-7B](#)