



UT3N10

Power MOSFET

N-CHANNEL ENHANCEMENT MODE POWER MOSFET

DESCRIPTION

The UTC **UT3N10** is an N-channel power MOSFET providing very low on-resistance. It has high efficiency and perfect cost-effectiveness. It can be generally applied in the commercial and industrial fields.

FEATURES

- * $R_{DS(ON)} \leq 0.165 \Omega$ @ $V_{GS}=10V, I_D=3.0A$
- $R_{DS(ON)} \leq 0.180 \Omega$ @ $V_{GS}=4.5V, I_D=2.0A$
- * Simple drive requirement

SYMBOL

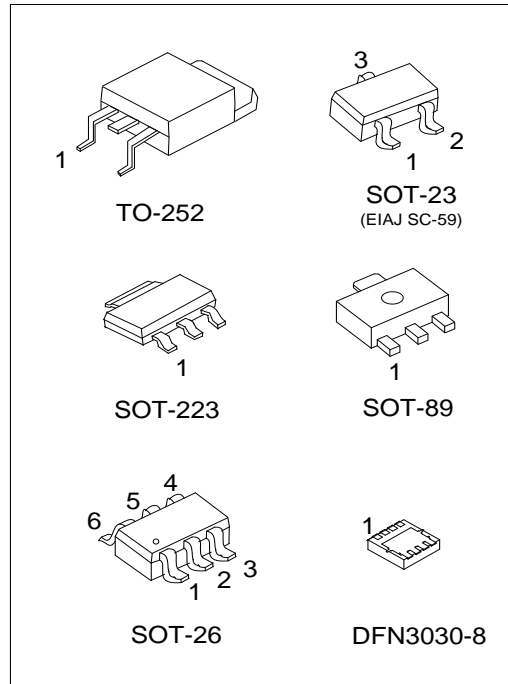
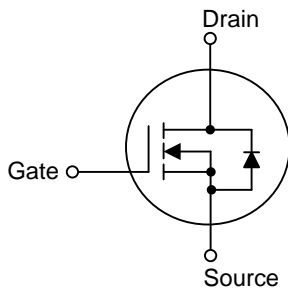

ORDERING INFORMATION

Ordering Number		Package	Pin Assignment								Packing
Lead Free	Halogen Free		1	2	3	4	5	6	7	8	
UT3N10L-AA3-R	UT3N10G-AA3-R	SOT-223	G	D	S	-	-	-	-	-	Tape Reel
UT3N10L-AB3-R	UT3N10G-AB3-R	SOT-89	G	D	S	-	-	-	-	-	Tape Reel
UT3N10L-AE3-R	UT3N10G-AE3-R	SOT-23	G	S	D	-	-	-	-	-	Tape Reel
UT3N10L-AG6-R	UT3N10G-AG6-R	SOT-26	D	D	G	S	D	D	-	-	Tape Reel
UT3N10L-TN3-R	UT3N10G-TN3-R	TO-252	G	D	S	-	-	-	-	-	Tape Reel
UT3N10L-K08-3030-R	UT3N10G-K08-3030-R	DFN3030-8	S	S	S	G	D	D	D	D	Tape Reel

Note: Pin Assignment: G: Gate D: Drain S: Source

<p>UT3N10G-AA3-R</p> <p>(1) Packing Type (2) Package Type (3) Green Package</p>	<p>(1) R: Tape Reel (2) AA3: SOT-223, AB3: SOT-89, AE3: SOT-23 AG6: SOT-26, TN3: TO-252 K08-3030: DFN3030-8 (3) G: Halogen Free and Lead Free, L: Lead Free</p>
---	---

MARKING

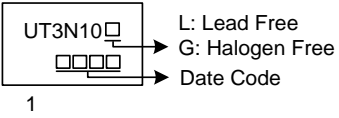
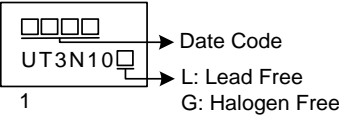
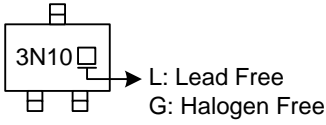
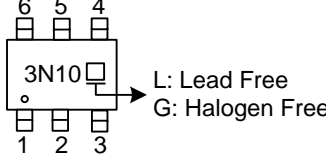
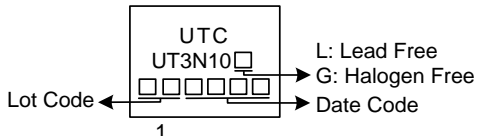
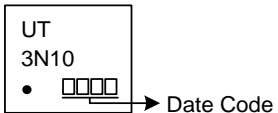
<p style="text-align: center;">SOT-223</p>  <p style="text-align: center;">1</p>	<p style="text-align: center;">SOT-89</p>  <p style="text-align: center;">1</p>
<p style="text-align: center;">SOT-23</p>  <p style="text-align: center;">1</p>	<p style="text-align: center;">SOT-26</p>  <p style="text-align: center;">1 2 3</p>
<p style="text-align: center;">TO-252</p>  <p style="text-align: center;">1</p>	<p style="text-align: center;">DFN3030-8</p>  <p style="text-align: center;">Date Code</p>

■ ABSOLUTE MAXIMUM RATINGS ($T_C = 25^\circ\text{C}$, unless otherwise specified)

PARAMETER	SYMBOL	RATINGS	UNIT
Drain-Source Voltage	V_{DSS}	100	V
Gate-Source Voltage	V_{GSS}	± 20	V
Continuous Drain Current ($V_{GS}=4.5\text{V}$, $T_A=25^\circ\text{C}$) (Note 2)	I_D	3.0	A
Pulsed Drain Current (Note 3, 4)	I_{DM}	10	A
Power Dissipation ($T_A=25^\circ\text{C}$)	SOT-223	0.89	W
	SOT-89	0.55	W
	SOT-23 SOT-26	0.35	W
	TO-252	2	W
	DFN3030-8	0.96	W
Junction Temperature	T_J	+150	$^\circ\text{C}$
Storage Temperature	T_{STG}	-55 ~ +150	$^\circ\text{C}$

Notes: 1. Absolute maximum ratings are those values beyond which the device could be permanently damaged.

Absolute maximum ratings are stress ratings only and functional device operation is not implied.

2. Surface mounted on 1 in² copper pad of FR4 board; 270 $^\circ\text{C/W}$ when mounted on min. copper pad.

3. Repetitive Rating: Pulse width limited by maximum junction temperature.

4. Pulse width $\leq 300\mu\text{s}$, duty cycle $\leq 2\%$.

■ THERMAL DATA

PARAMETER	SYMBOL	RATING	UNIT
Junction to Ambient (Note)	SOT-223	140	$^\circ\text{C/W}$
	SOT-89	180	$^\circ\text{C/W}$
	SOT-23 SOT-26	350	$^\circ\text{C/W}$
	TO-252	62.5	$^\circ\text{C/W}$
	DFN3030-8	130	$^\circ\text{C/W}$

Note: Device mounted on FR-4 substrate PC board, 2oz copper, with 1inch square copper plate.

■ **ELECTRICAL CHARACTERISTICS** ($T_J = 25^\circ\text{C}$, unless otherwise specified)

PARAMETER	SYMBOL	TEST CONDITIONS	MIN	TYP	MAX	UNIT
OFF CHARACTERISTICS						
Drain-Source Breakdown Voltage	BV_{DSS}	$V_{GS}=0V, I_D=250\mu A$	100			V
Drain-Source Leakage Current	I_{DSS}	$V_{DS}=100V, V_{GS}=0V$			10	μA
Gate-Source Leakage Current	I_{GSS}	$V_{GS}=\pm 20V$			± 100	nA
ON CHARACTERISTICS						
Gate Threshold Voltage	$V_{GS(TH)}$	$V_{DS}=V_{GS}, I_D=250\mu A$	1.0		3.0	V
Drain to Source On-state Resistance	$R_{DS(ON)}$	$V_{GS}=10V, I_D=3.0A$			0.165	Ω
		$V_{GS}=4.5V, I_D=2.0A$			0.180	Ω
DYNAMIC PARAMETERS						
Input Capacitance	C_{ISS}	$V_{DS}=25V, V_{GS}=0V, f=1.0MHz$		720		pF
Output Capacitance	C_{OSS}			45		pF
Reverse Transfer Capacitance	C_{RSS}			36		pF
SWITCHING PARAMETERS						
Total Gate Charge (Note)	Q_G	$V_{GS}=10V, V_{DS}=80V, I_D=3A$		20		nC
Gate Source Charge	Q_{GS}			3.2		nC
Gate Drain Charge	Q_{GD}			4.2		nC
Turn-ON Delay Time (Note)	$t_{D(ON)}$	$V_{GS}=10V, V_{DS}=50V, I_D=3A, R_G=25\Omega$		8		ns
Turn-ON Rise Time	t_R			18		ns
Turn-OFF Delay Time	$t_{D(OFF)}$			75		ns
Turn-OFF Fall-Time	t_F			30		ns
SOURCE- DRAIN DIODE RATINGS AND CHARACTERISTICS						
Drain-Source Diode Forward Voltage (Note)	V_{SD}	$I_S=1.2A, V_{GS}=0V$			1.2	V
Reverse Recovery Time	t_{rr}	$I_S=3A, V_{GS}=0V, di/dt=100A/\mu s$		50		ns
Reverse Recovery Charge	Q_{rr}			140		nC

Note: Pulse width $\leq 300\mu s$, duty cycle $\leq 2\%$.

■ TEST WAVEFORMS

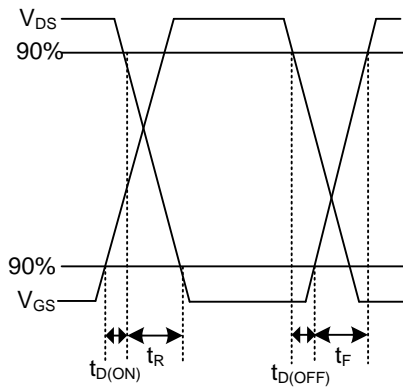

Switching Time Waveform

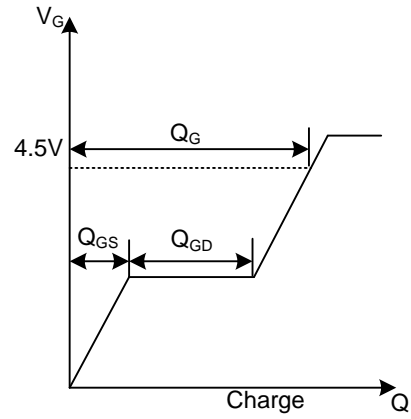

Gate Charge Waveform

TYPICAL CHARACTERISTICS

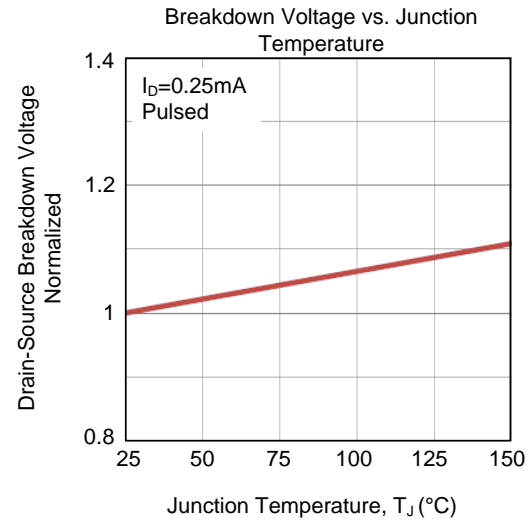
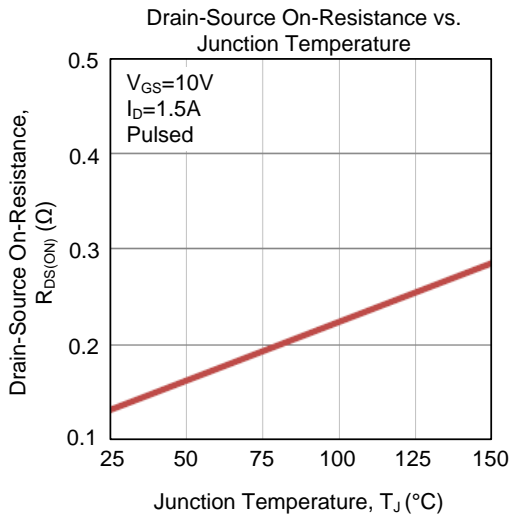
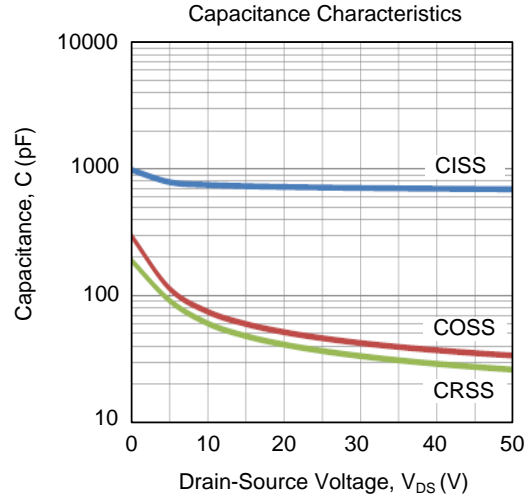
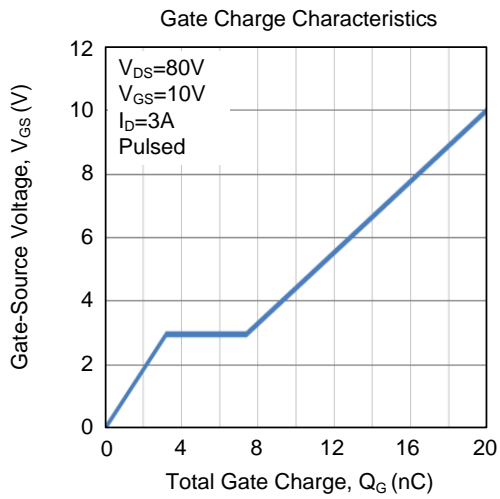
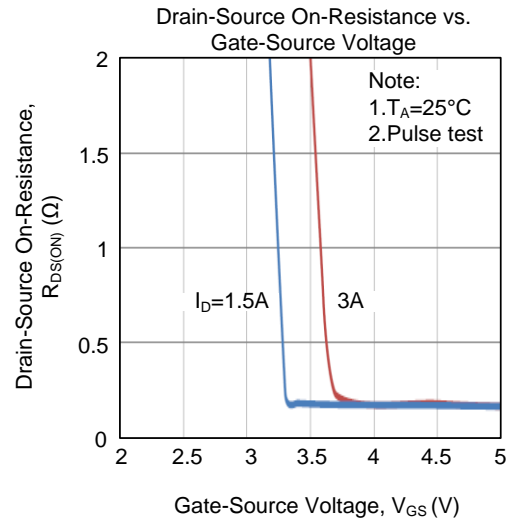
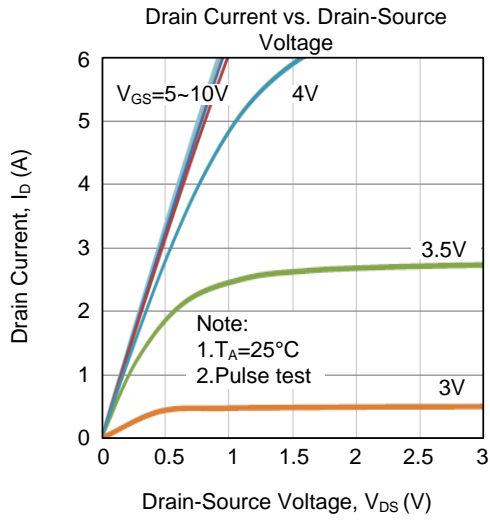

■ TYPICAL CHARACTERISTICS (Cont.)

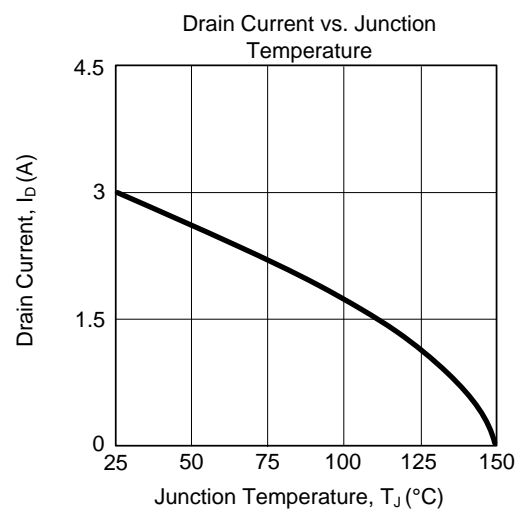
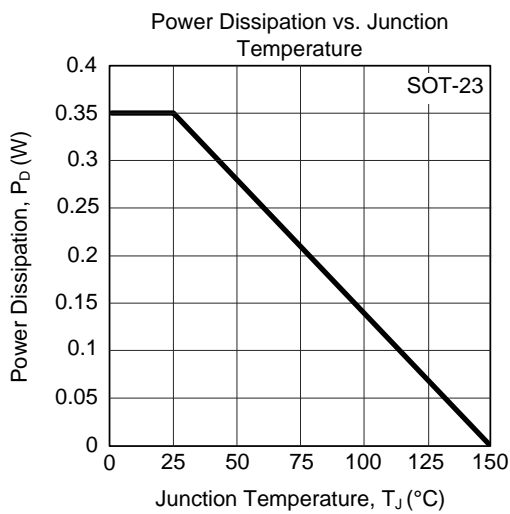
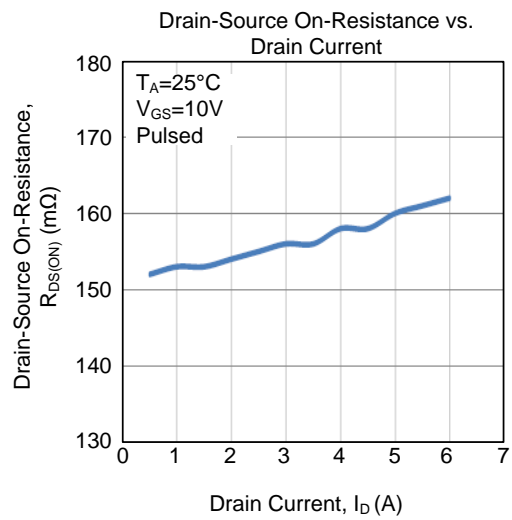
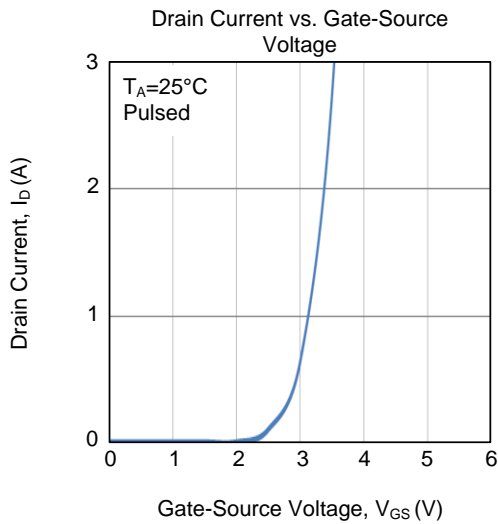
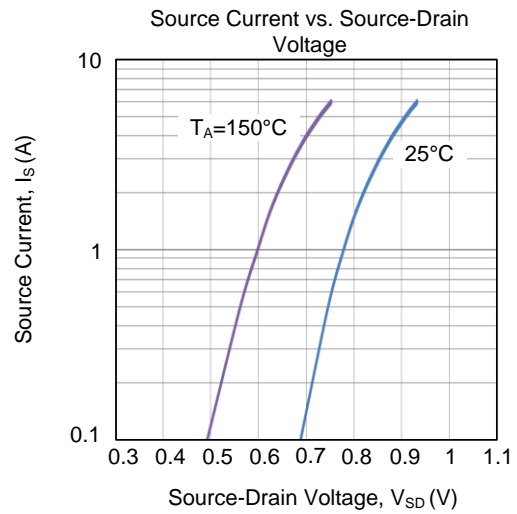
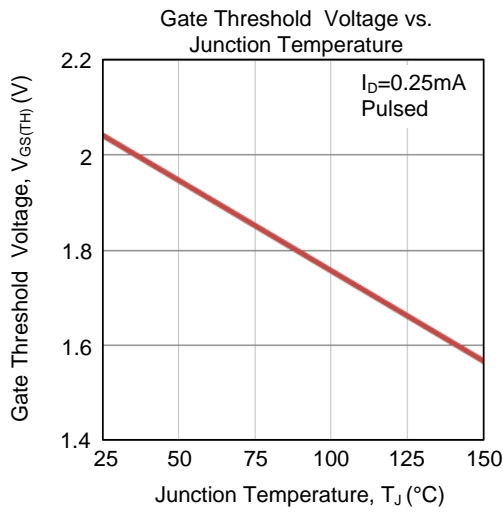

■ TYPICAL CHARACTERISTICS (Cont.)

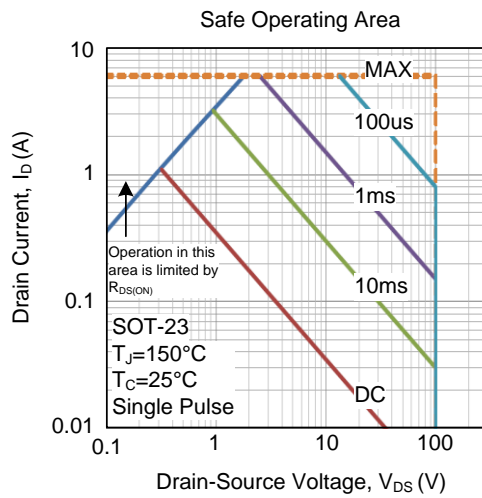

UTC assumes no responsibility for equipment failures that result from using products at values that exceed, even momentarily, rated values (such as maximum ratings, operating condition ranges, or other parameters) listed in products specifications of any and all UTC products described or contained herein. UTC products are not designed for use in life support appliances, devices or systems where malfunction of these products can be reasonably expected to result in personal injury. Reproduction in whole or in part is prohibited without the prior written consent of the copyright owner. UTC reserves the right to make changes to information published in this document, including without limitation specifications and product descriptions, at any time and without notice. This document supersedes and replaces all information supplied prior to the publication hereof.

X-ON Electronics

Largest Supplier of Electrical and Electronic Components

Click to view similar products for [MOSFET](#) category:

Click to view products by [Unisonic](#) manufacturer:

Other Similar products are found below :

[IRFD120](#) [JANTX2N5237](#) [BUK455-60A/B](#) [MIC4420CM-TR](#) [VN1206L](#) [NDP4060](#) [SI4482DY](#) [IPS70R2K0CEAKMA1](#) [SQD23N06-31L-GE3](#)
[TK16J60W,S1VQ\(O](#) [2SK2614\(TE16L1,Q\)](#) [DMN1017UCP3-7](#) [DMN1053UCP4-7](#) [SQJ469EP-T1-GE3](#) [NTE2384](#) [DMC2700UDMQ-7](#)
[DMN2080UCB4-7](#) [DMN61D9UWQ-13](#) [US6M2GTR](#) [DMN31D5UDJ-7](#) [DMP22D4UFO-7B](#) [DMN1006UCA6-7](#) [DMN16M9UCA6-7](#)
[STF5N65M6](#) [IRF40H233XTMA1](#) [STU5N65M6](#) [DMN6022SSD-13](#) [DMN13M9UCA6-7](#) [DMTH10H4M6SPS-13](#) [DMN2990UFB-7B](#)
[IPB80P04P405ATMA2](#) [2N7002W-G](#) [MCAC30N06Y-TP](#) [MCQ7328-TP](#) [BXP7N65D](#) [BXP4N65F](#) [AOL1454G](#) [WMJ80N60C4](#) [BXP2N20L](#)
[BXP2N65D](#) [BXT1150N10J](#) [BXT1700P06M](#) [TSM60NB380CP ROG](#) [RQ7L055BGTCR](#) [DMNH15H110SK3-13](#) [SLF10N65ABV2](#)
[BSO203SP](#) [BSO211P](#) [IPA60R230P6](#) [IPA60R460CE](#)