



## UTD408

Power MOSFET

### N-CHANNEL ENHANCEMENT MODE

#### FEATURES

- \*  $R_{DS(ON)} = 18m\Omega @ V_{GS} = 10V$
- \* Low capacitance
- \* Optimized gate charge
- \* Fast switching capability
- \* Avalanche energy specified

#### SYMBOL

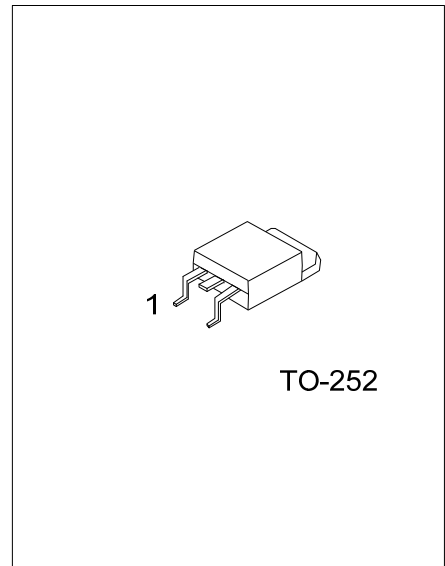
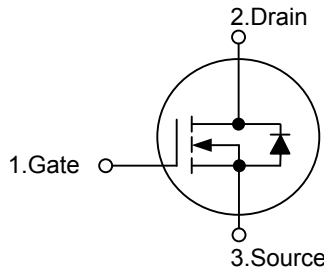

#### ORDERING INFORMATION

Ordering Number		Package	Pin Assignment			Packing
Lead Free	Halogen Free		1	2	3	
UTD408L-TN3-R	UTD408G-TN3-R	TO-252	G	D	S	Tape Reel

Note: Pin Assignment: G: Gate D: Drain S: Source

<p>UTD408L-TN3-R</p> <p>(1) Packing Type</p> <p>(2) Package Type</p> <p>(3) Green Package</p>	<p>(1) R: Tape Reel</p> <p>(2) TN3: TO-252</p> <p>(3) L: Lead Free, G: Halogen Free and Lead Free</p>
---	---

#### MARKING

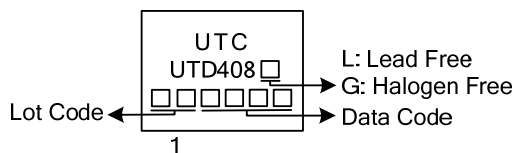

■ ABSOLUTE MAXIMUM RATINGS ( $T_A = 25^\circ\text{C}$ , unless otherwise specified)

PARAMETER	SYMBOL	RATINGS	UNIT	
Drain-Source Voltage	$V_{DSS}$	30	V	
Gate-Source Voltage	$V_{GSS}$	$\pm 20$	V	
Continuous Drain Current ( $T_C=25^\circ\text{C}$ ) (Note 4)	$I_D$	18	A	
Pulsed Drain Current (Note 3)	$I_{DM}$	40	A	
Avalanche Current (Note 3)	$I_{AR}$	18	A	
Repetitive Avalanche Energy ( $L=0.1\text{mH}$ ) (Note 3)	$E_{AR}$	40	mJ	
Power Dissipation	$P_D$	$T_A=25^\circ\text{C}$ (Note 1)	2.5	W
		$T_C=25^\circ\text{C}$ (Note 2)	60	W
Junction Temperature	$T_J$	+150	$^\circ\text{C}$	
Storage Temperature	$T_{STG}$	-55 ~ +150	$^\circ\text{C}$	

Note: Absolute maximum ratings are those values beyond which the device could be permanently damaged. Absolute maximum ratings are stress ratings only and functional device operation is not implied.

■ THERMAL DATA

PARAMETER	SYMBOL	RATING	UNIT
Junction to Ambient (Note 1)	$\theta_{JA}$	50	$^\circ\text{C/W}$
Junction to Case (Note 3)	$\theta_{JC}$	2.08	$^\circ\text{C/W}$

Notes: 1. The value of  $R_{\theta_{JA}}$  is measured with the device mounted on  $1\text{in}^2$  FR-4 board with 2oz. Copper, and the maximum temperature of  $150^\circ\text{C}$  may be used if the PCB or heat-sink allows it.

2. The power dissipation  $P_D$  is based on  $T_{J(\text{MAX})} = 150^\circ\text{C}$ , using junction-to-case thermal resistance, and is more useful in setting the upper dissipation limit for cases where additional heat-sinking is used.

3. Repetitive rating, pulse width limited by junction temperature  $T_{J(\text{MAX})} = 150^\circ\text{C}$ .

4. The maximum current rating is limited by bond-wires.

■ ELECTRICAL CHARACTERISTICS (T<sub>J</sub> =25°C, unless otherwise specified)

PARAMETER	SYMBOL	TEST CONDITIONS	MIN	TYP	MAX	UNIT
<b>OFF CHARACTERISTICS</b>						
Drain-Source Breakdown Voltage	BV <sub>DSS</sub>	V <sub>GS</sub> =0 V, I <sub>D</sub> =250μA	30			V
Drain-Source Leakage Current	I <sub>DSS</sub>	V <sub>DS</sub> =24V, V <sub>GS</sub> =0 V			1	μA
Gate-Body Leakage Current	I <sub>GSS</sub>	V <sub>DS</sub> =0 V, V <sub>GS</sub> = ±20V			100	nA
<b>ON CHARACTERISTICS</b>						
Gate Threshold Voltage	V <sub>GS(TH)</sub>	V <sub>DS</sub> =V <sub>GS</sub> , I <sub>D</sub> =250 μA	1	1.8	2.5	V
On State Drain Current	I <sub>D(ON)</sub>	V <sub>DS</sub> =5V, V <sub>GS</sub> =4.5V	40			A
Static Drain-Source On-Resistance	R <sub>DS(ON)</sub>	V <sub>GS</sub> =10V, I <sub>D</sub> =18A		13.6	18	mΩ
		V <sub>GS</sub> =4.5V, I <sub>D</sub> =10A		20.6	27	mΩ
<b>DYNAMIC PARAMETERS</b>						
Input Capacitance	C <sub>ISS</sub>	V <sub>DS</sub> =15 V, V <sub>GS</sub> =0V, f=1MHz		1040	1250	pF
Output Capacitance	C <sub>OSS</sub>			180		pF
Reverse Transfer Capacitance	C <sub>RSS</sub>			110		pF
<b>SWITCHING PARAMETERS</b>						
Total Gate Charge	Q <sub>G</sub>	V <sub>DS</sub> =15V, V <sub>GS</sub> =10V, I <sub>D</sub> =18A		19.8	25	nC
Gate Source Charge	Q <sub>GS</sub>			2.5		nC
Gate Drain Charge	Q <sub>GD</sub>			3.5		nC
Turn-ON Delay Time	t <sub>D(ON)</sub>	V <sub>GS</sub> =10V, V <sub>DS</sub> =15V, R <sub>L</sub> =0.82Ω, R <sub>GEN</sub> =3Ω		4.5		ns
Turn-ON Rise Time	t <sub>R</sub>			3.9		ns
Turn-OFF Delay Time	t <sub>D(OFF)</sub>			17.4		ns
Turn-OFF Fall-Time	t <sub>F</sub>			3.2		ns
<b>SOURCE- DRAIN DIODE RATINGS AND CHARACTERISTICS</b>						
Maximum Continuous Drain-Source Diode Forward Current	I <sub>S</sub>				18	A
Drain-Source Diode Forward Voltage	V <sub>SD</sub>	I <sub>S</sub> =1A, V <sub>GS</sub> =0V		0.75	1	V
Body Diode Reverse Recovery Time	t <sub>RR</sub>	I <sub>F</sub> =18 A, dI/dt=100A/μs		19	25	ns
Body Diode Reverse Recovery Charge	Q <sub>RR</sub>	I <sub>F</sub> =18 A, dI/dt=100A/μs		8		nC

Notes: 5. Pulse width limited by T<sub>J(MAX)</sub>

6. Pulse width ≤300us, duty cycle ≤2%.

## TYPICAL CHARACTERISTICS

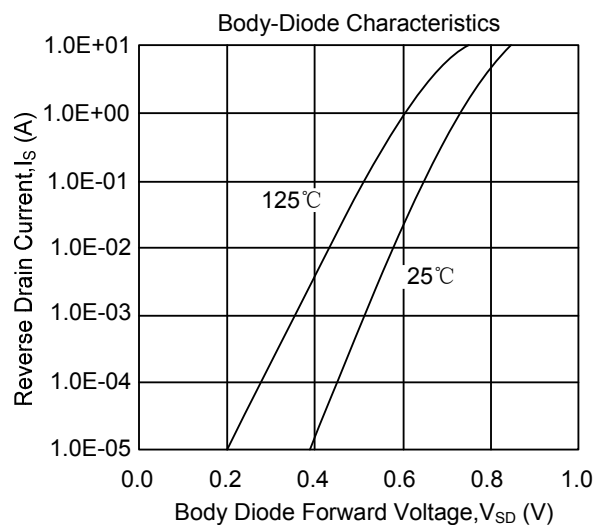
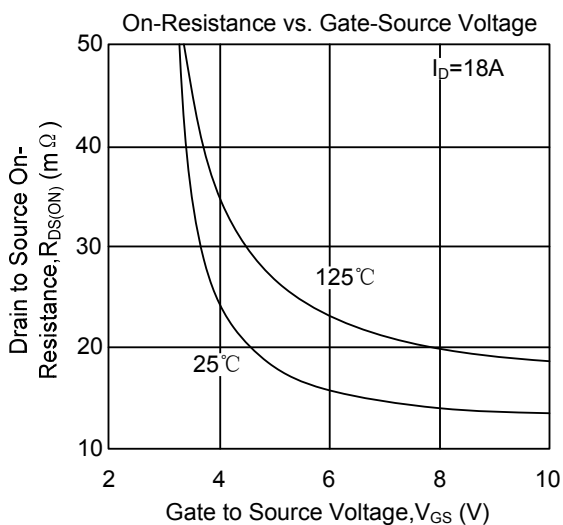
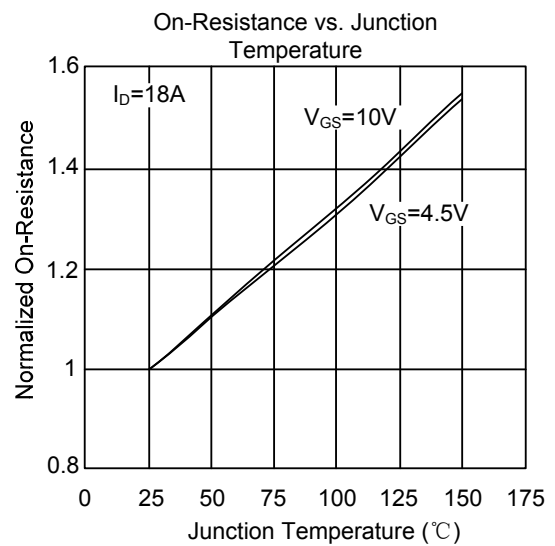
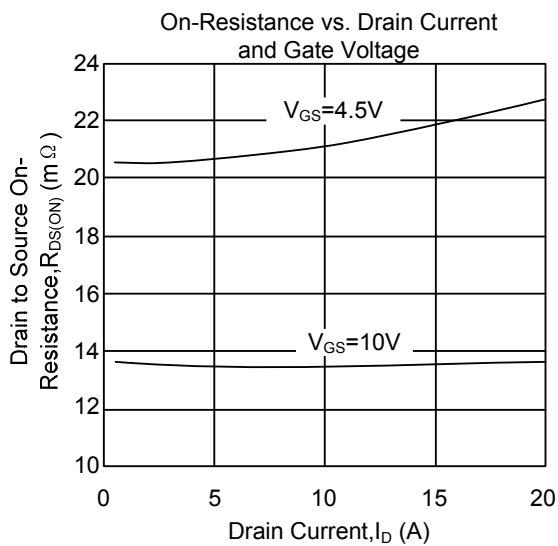
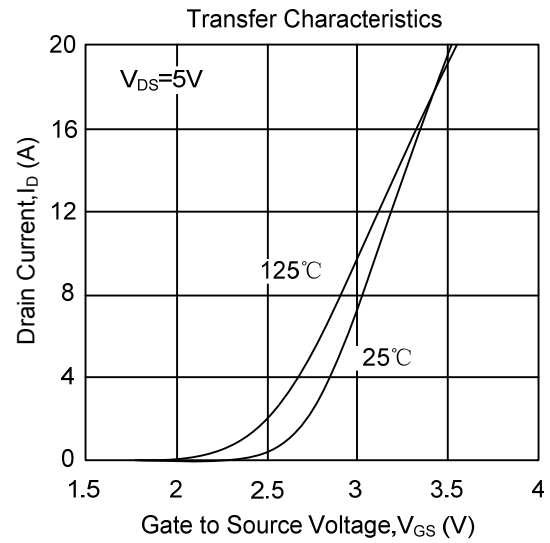
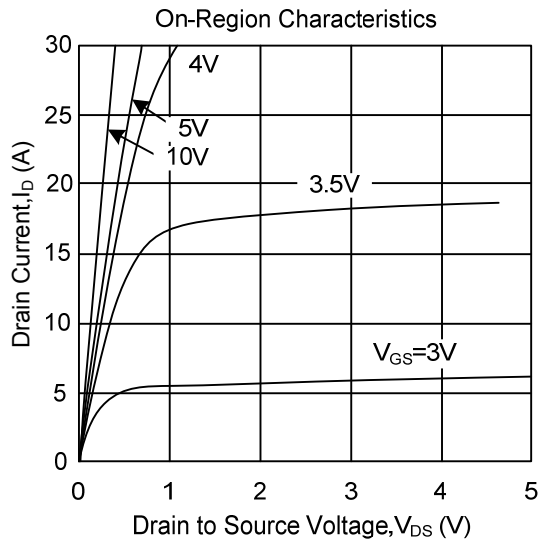

## TYPICAL CHARACTERISTICS (Cont.)

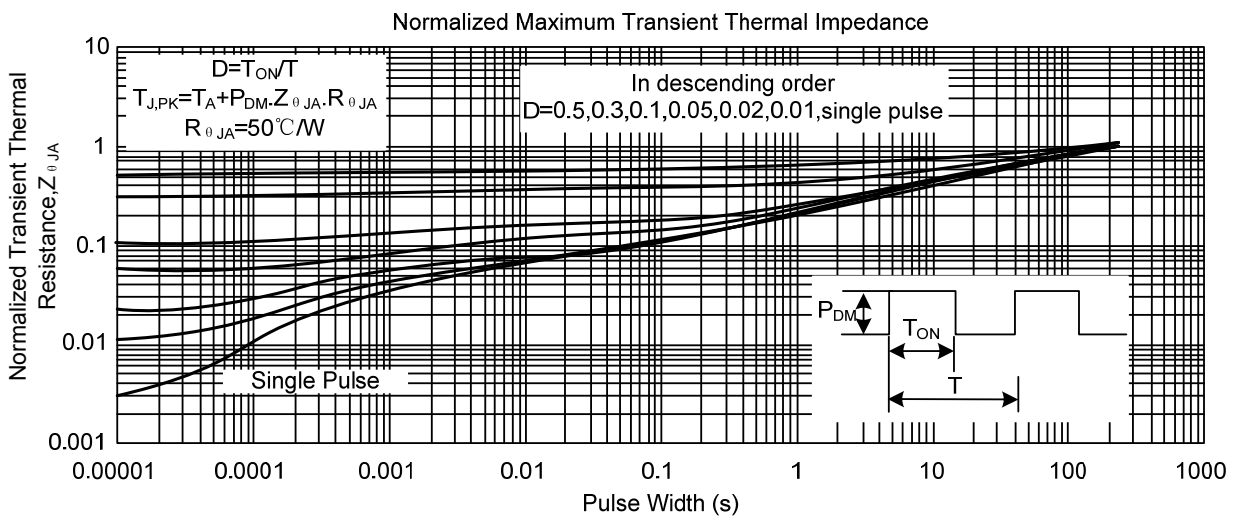
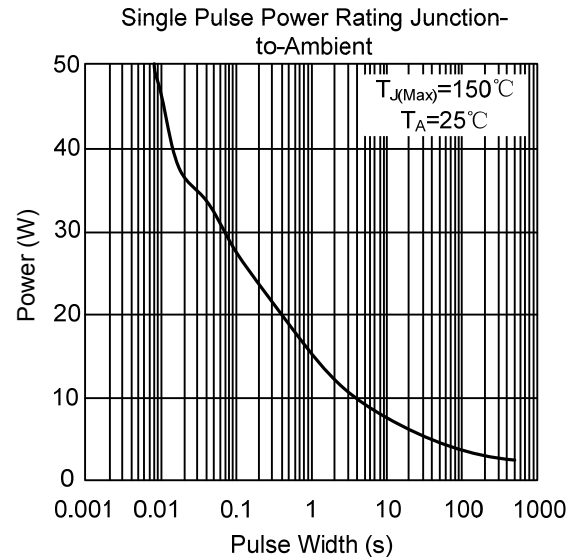
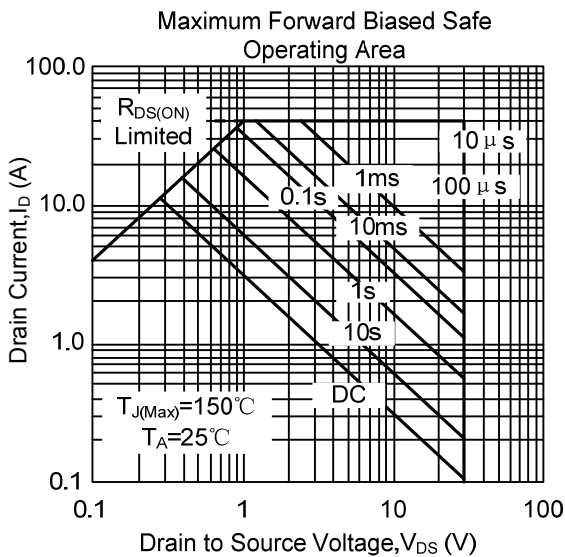
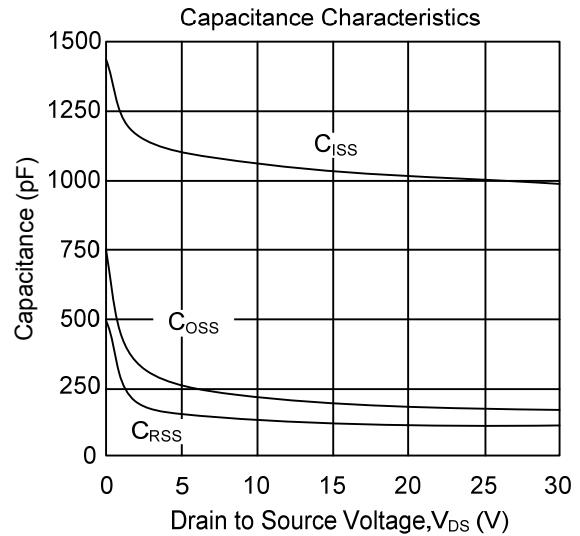
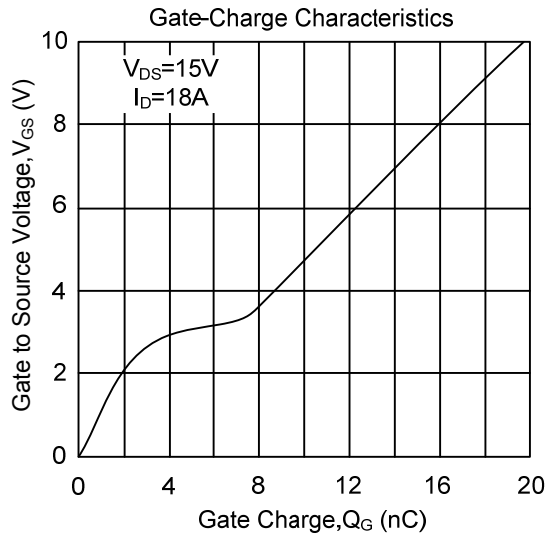

## ■ TYPICAL CHARACTERISTICS (Cont.)

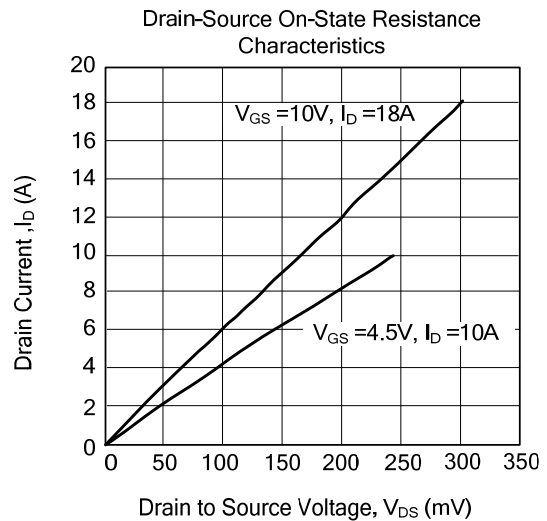
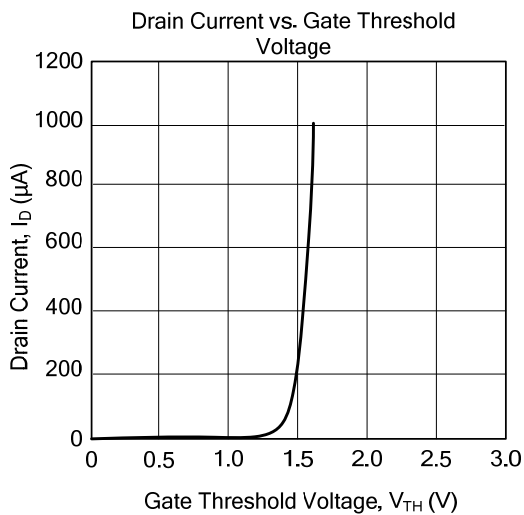
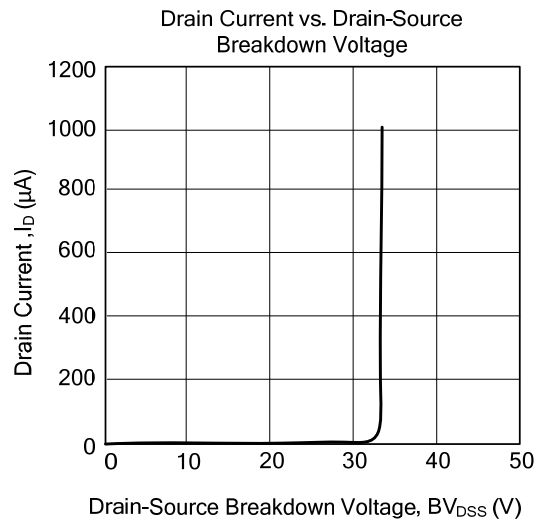
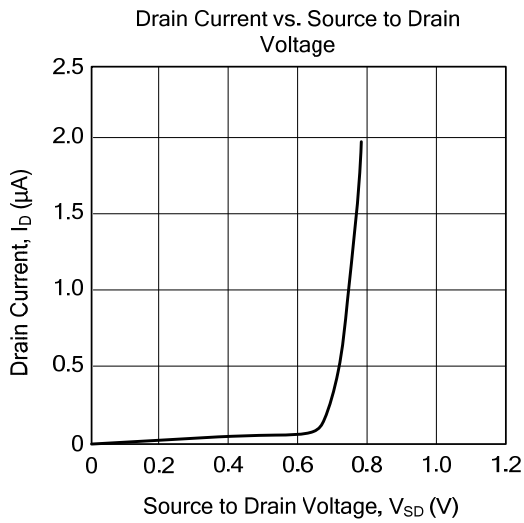

UTC assumes no responsibility for equipment failures that result from using products at values that exceed, even momentarily, rated values (such as maximum ratings, operating condition ranges, or other parameters) listed in products specifications of any and all UTC products described or contained herein. UTC products are not designed for use in life support appliances, devices or systems where malfunction of these products can be reasonably expected to result in personal injury. Reproduction in whole or in part is prohibited without the prior written consent of the copyright owner. The information presented in this document does not form part of any quotation or contract, is believed to be accurate and reliable and may be changed without notice.

## X-ON Electronics

Largest Supplier of Electrical and Electronic Components

*Click to view similar products for [MOSFET](#) category:*

*Click to view products by [Unisonic](#) manufacturer:*

Other Similar products are found below :

[614233C](#) [648584F](#) [FDPF9N50NZ](#) [IRFD120](#) [IRFF430](#) [JANTX2N5237](#) [2N7000](#) [FCA20N60\\_F109](#) [FDZ595PZ](#) [2SK2267\(Q\)](#) [2SK2545\(Q,T\)](#)  
[405094E](#) [423220D](#) [MIC4420CM-TR](#) [VN1206L](#) [614234A](#) [715780A](#) [SSM6J414TU,LF\(T](#) [751625C](#) [PSMN4R2-30MLD](#)  
[TK31J60W5,S1VQ\(O](#) [2SK2614\(TE16L1,Q\)](#) [DMN1017UCP3-7](#) [EFC2J004NUZTDG](#) [FCAB21350L1](#) [P85W28HP2F-7071](#) [DMN1053UCP4-7](#)  
[NTE2384](#) [NTE2969](#) [NTE6400A](#) [DMN61D9UWQ-13](#) [US6M2GTR](#) [DMN31D5UDJ-7](#) [SSM6P54TU,LF](#) [DMP22D4UFO-7B](#)  
[IPS60R3K4CEAKMA1](#) [DMN1006UCA6-7](#) [DMN16M9UCA6-7](#) [STF5N65M6](#) [STU5N65M6](#) [C3M0021120D](#) [DMN13M9UCA6-7](#)  
[BSS340NWH6327XTSA1](#) [MCM3400A-TP](#) [DMTH10H4M6SPS-13](#) [IPS60R1K0PFD7SAKMA1](#) [IPS60R360PFD7SAKMA1](#)  
[IPS60R600PFD7SAKMA1](#) [IPS60R210PFD7SAKMA1](#) [DMN2990UFB-7B](#)