

12-16GHz Integrated Down Converter

GaAs Monolithic Microwave IC in SMD leadless package

Description

The CHR3763-QDG is a multifunction monolithic receiver, which integrates a balanced cold FET mixer, a LO buffer, and a RF low noise amplifier.

It is designed for a wide range of applications, from military to commercial communication systems.

The circuit is manufactured with a pHEMT process, 0.25µm gate length.

It is supplied in RoHS compliant SMD package.

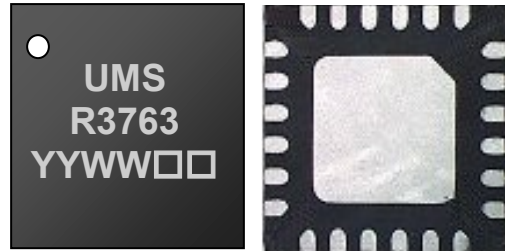

Main Features

- Broadband RF performances: 12-16GHz
- 12dB Conversion Gain
- 2.3dB Noise Figure
- 0dBm Input IP3
- DC bias: Vd=3.0V @Id= 80mA
- 24L-QFN4x4
- MSL1

Conversion Gain & Noise Figure versus RF frequency @ IF = 2GHz (LSB mode)

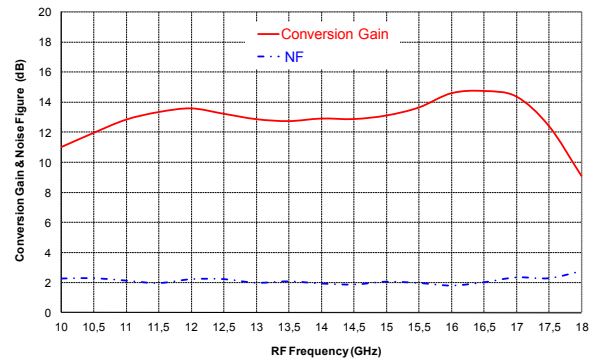

Main Electrical Characteristics

Tamb.= +25°C

Symbol	Parameter	Min	Typ	Max	Unit
F _{RF}	RF Frequency	12		16	GHz
F _{IF}	IF frequency	DC		3.5	GHz
G	Conversion gain		12		dB
NF	Noise Figure		2.3		dB

Electrical Characteristics

Tamb.= +25°C, VD1= VD2= VD3 = +3.0V ⁽¹⁾

Symbol	Parameter	Min	Typ	Max	Unit
F _{RF}	RF Frequency range	12		16	GHz
F _{LO}	LO frequency range	8.5		19.5	GHz
F _{IF}	IF frequency range	DC		3.5	GHz
G	Conversion gain ⁽²⁾		12		dB
NF	Noise Figure		2.3		dB
Im_rej	Image rejection ⁽²⁾		20		dBc
P _{LO}	LO Input power		5		dBm
IIP3	Input IP3		0		dBm
LO RL	LO return loss		12		dB
RF RL	RF return loss		10		dB
VDx	DC drain voltage ⁽¹⁾		3		V
VG1	1 st stage LNA DC gate voltage		-0.52		V
VG2	2 nd stage LNA DC gate voltage		-0.46		V
VG3	LO buffer DC gate voltage		-0.46		V
VG4	Mixer DC gate voltage		-1		V
Id	Total drain current (ID1+ID2+ID3) ⁽³⁾		80		mA

These values are representative of onboard measurements as defined on the drawing in paragraph "Evaluation mother board".

⁽¹⁾ VD1: 1st stage LNA drain bias voltage. VD2: 2nd stage LNA drain bias voltage.

⁽¹⁾ VD3: LO-chain drain bias voltage.

⁽²⁾ An external combiner 90° is required on I / Q.

⁽³⁾ ID1: 1st stage LNA drain current, typically 14mA, should be tuned with VG1.

⁽³⁾ ID2: 2nd stage LNA drain current, typically 31mA, should be tuned with VG2.

⁽³⁾ ID3: LO-chain drain current, typically 35mA, should be tuned with VG3.

Electrostatic discharge sensitive device observe handling precautions!

Absolute Maximum Ratings ⁽¹⁾T_{amb.} = +25°C

Symbol	Parameter	Values	Unit
V _{dx}	Drain bias voltage	3.5	V
I _d	Drain bias current	120	mA
VG1, VG2	LNA gate bias voltages	-2 to +0.4	V
VG3	LO buffer gate bias voltage	-2 to +0.4	V
VG4	Mixer gate bias voltage	-2 to +0.4	V
P _{RF}	Maximum peak input power overdrive ⁽²⁾	+15	dBm
P _{LO}	Maximum LO input power	+10	dBm
T _j	Junction temperature	175	°C
T _a	Operating temperature range	-40 to +85	°C
T _{stg}	Storage temperature range	-55 to +150	°C

⁽¹⁾ Operation of this device above anyone of these parameters may cause permanent damage.

⁽²⁾ Duration < 1s.

Typical Bias ConditionsT_{amb.} = +25°C

Symbol	Pad N°	Parameter	Values	Unit
V _{Dx}	13,15,18	DC drain voltages	3	V
I _d	13,15,18	Total drain current	80	mA
VG1	12	1 st stage LNA DC gate voltage (14mA)	-0.52	V
VG2	14	2 nd stage LNA DC gate voltage (31mA)	-0.46	V
VG3	19	LO buffer DC gate voltage (35mA)	-0.46	V
VG4	17	Mixer DC gate voltage	-1	V

Device thermal performances

All the figures given in this section are obtained assuming that the QFN device is cooled down only by conduction through the package thermal pad (no convection mode considered). The temperature is monitored at the package back-side interface (Tcase) as shown below. The system maximum temperature must be adjusted in order to guarantee that Tcase remains below the maximum value specified in the next table. So, the PCB system must be designed to comply with this requirement.

A derating must be applied on the dissipated power if the Tcase temperature cannot be maintained below the maximum temperature specified (see the curve Pdiss. Max) in order to guarantee the nominal device life time (MTTF).

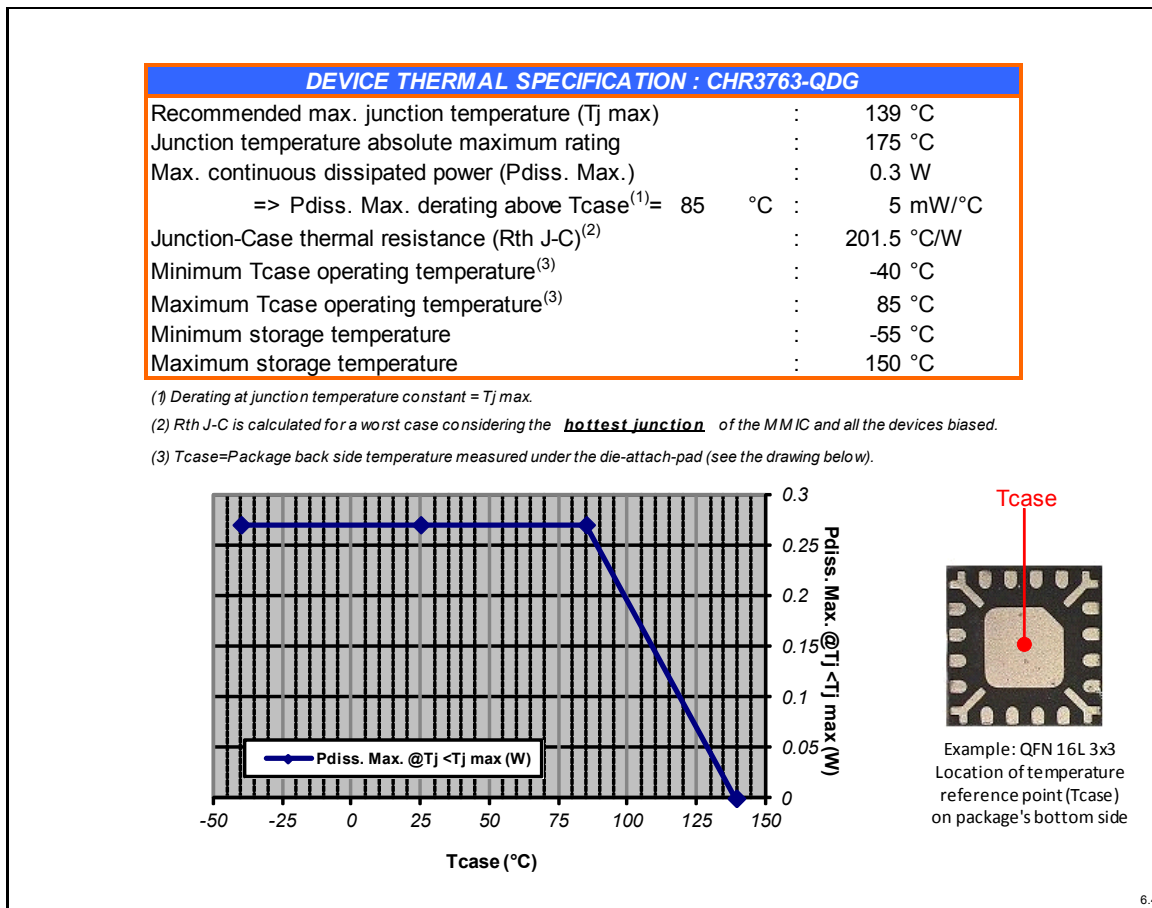

Typical Board Measurements

Tamb.= +25°C, VD1= VD2= VD3= +3V, VG4= -1V, P_LO = +5dBm

These values are representative of onboard measurements as defined on the drawing in paragraph "Evaluation mother board". Data are given in the package access planes.

Conversion Gain versus RF & LO power at IF = 2GHz
(LSB mode)

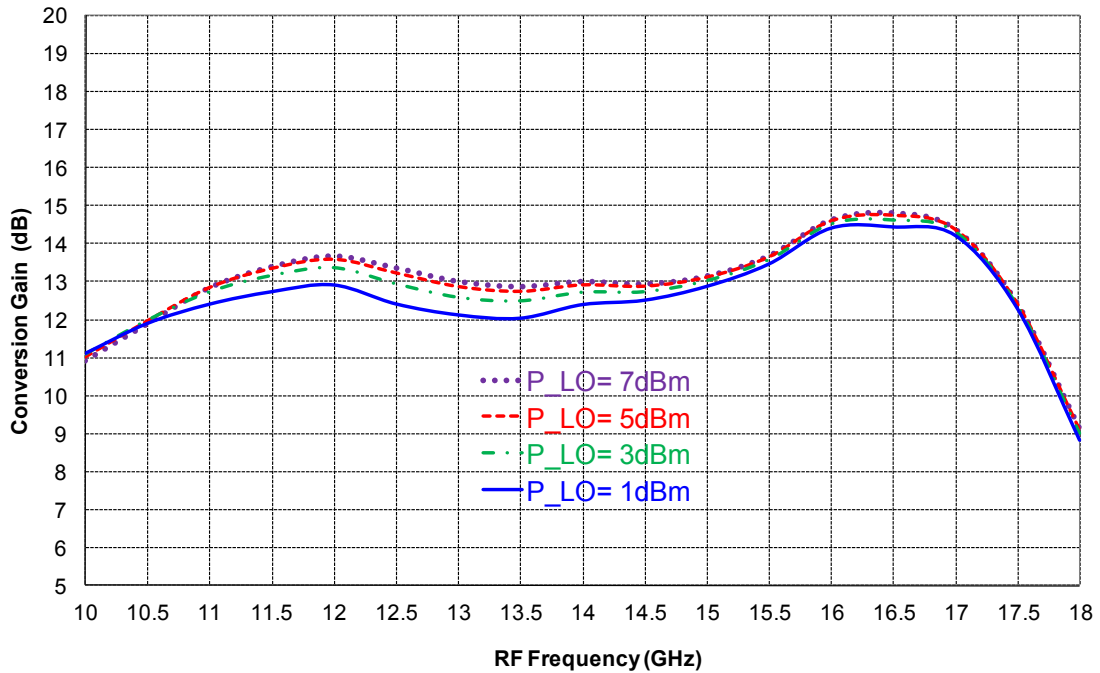
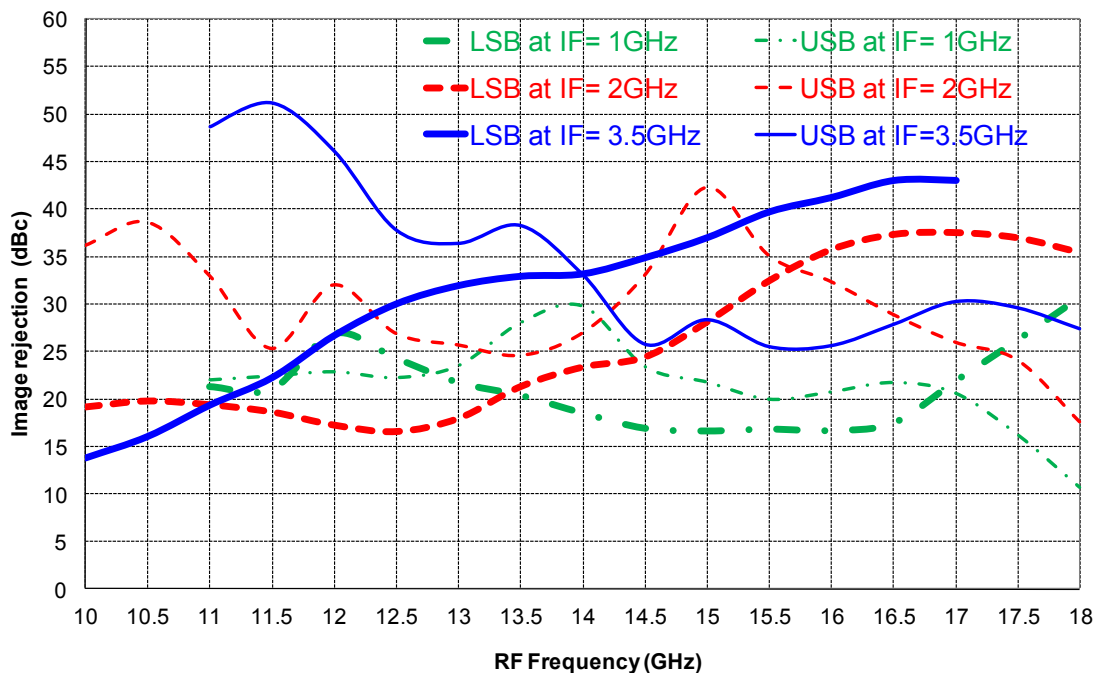

Image Rejection versus RF and IF frequencies



Typical Board Measurements

Tamb.= +25°C, VD1= VD2= VD3= +3V, VG4= -1V, P_LO = +5dBm

**Noise Figure versus RF and IF frequencies
(LSB mode)**

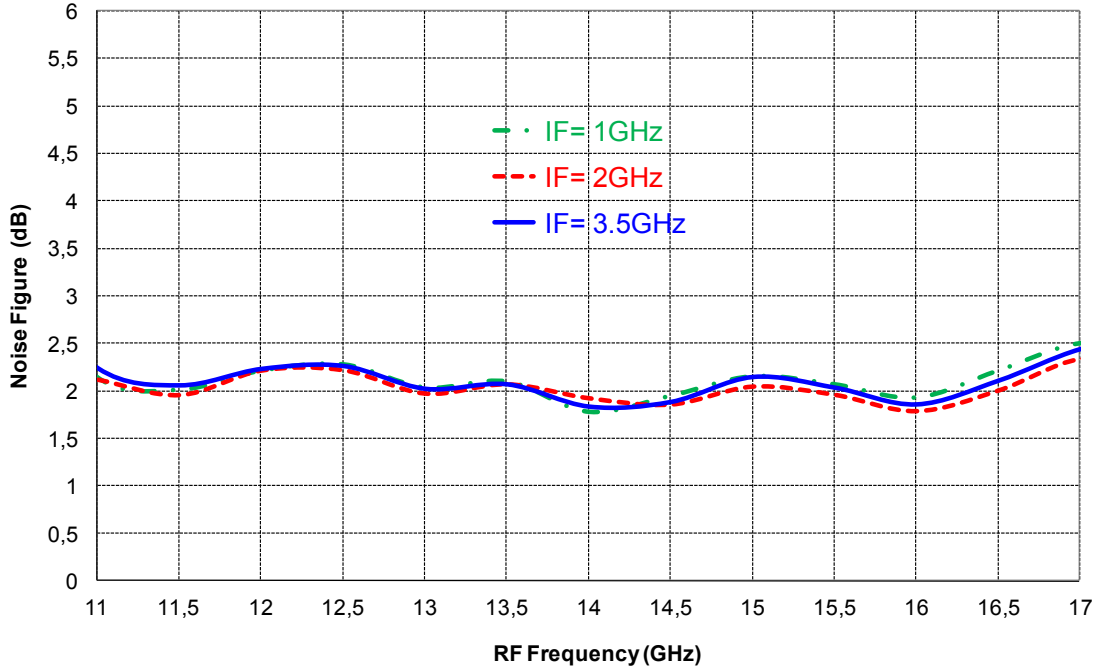

**Input IP3 versus LO power at RF =14.5GHz & IF = 2GHz
(USB mode)**

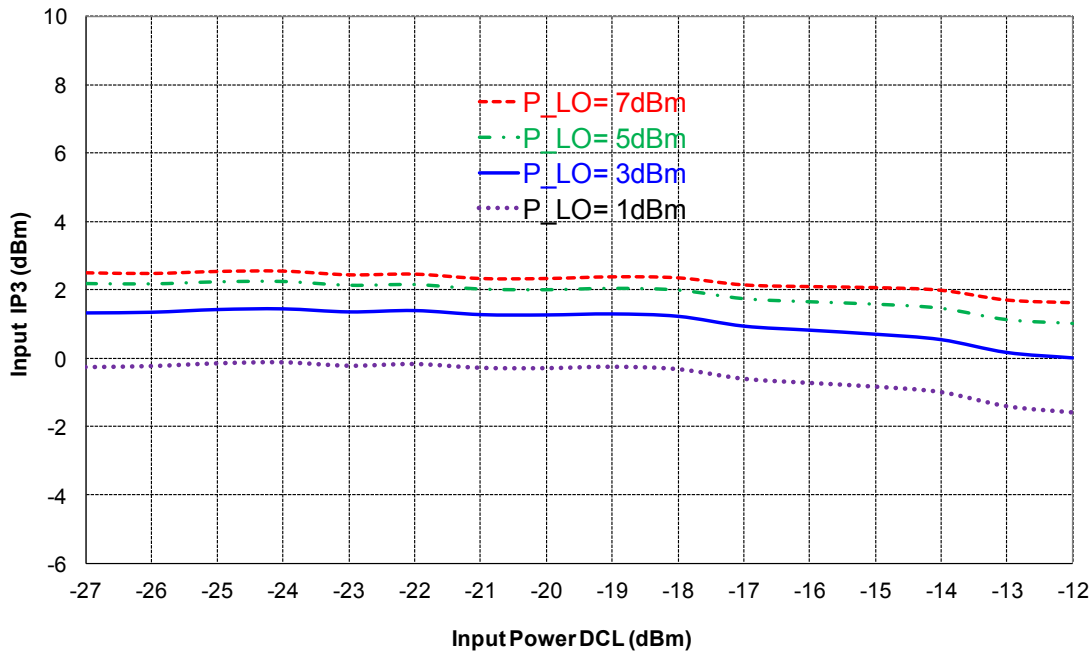

Typical Board Measurements

Tamb.= +25°C, VD1= VD2= VD3= +3V, VG4= -1V, P_LO = +5dBm

Input IP3 versus RF frequency at IF = 2GHz
(USB & LSB modes)

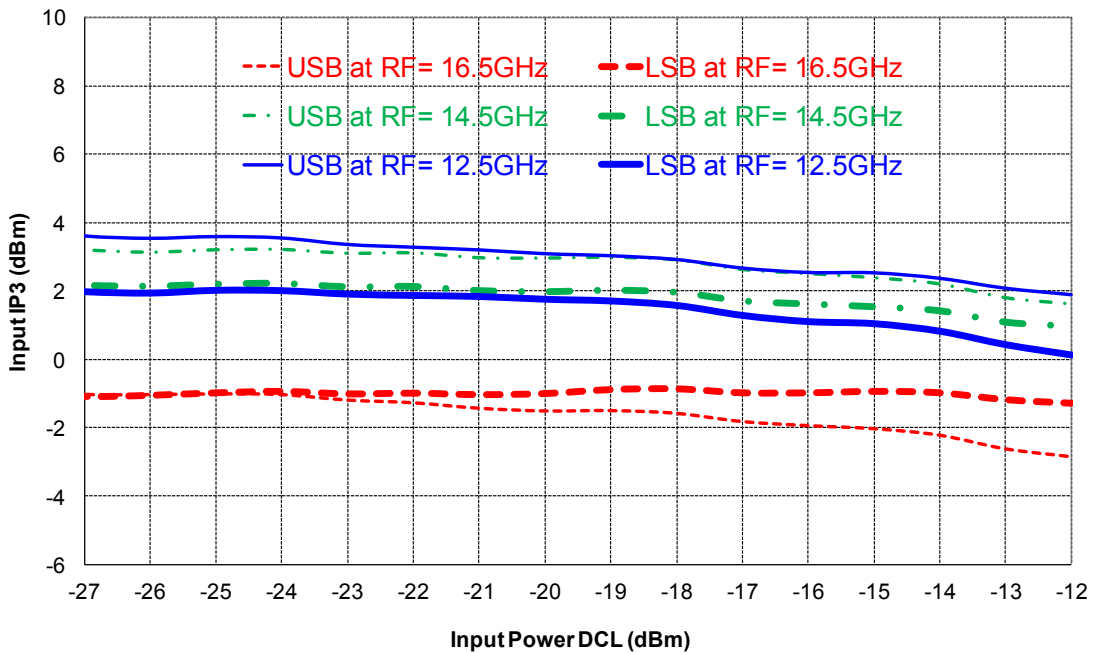

Input IP3 versus RF frequency at IF = 3.5GHz
(USB & LSB modes)

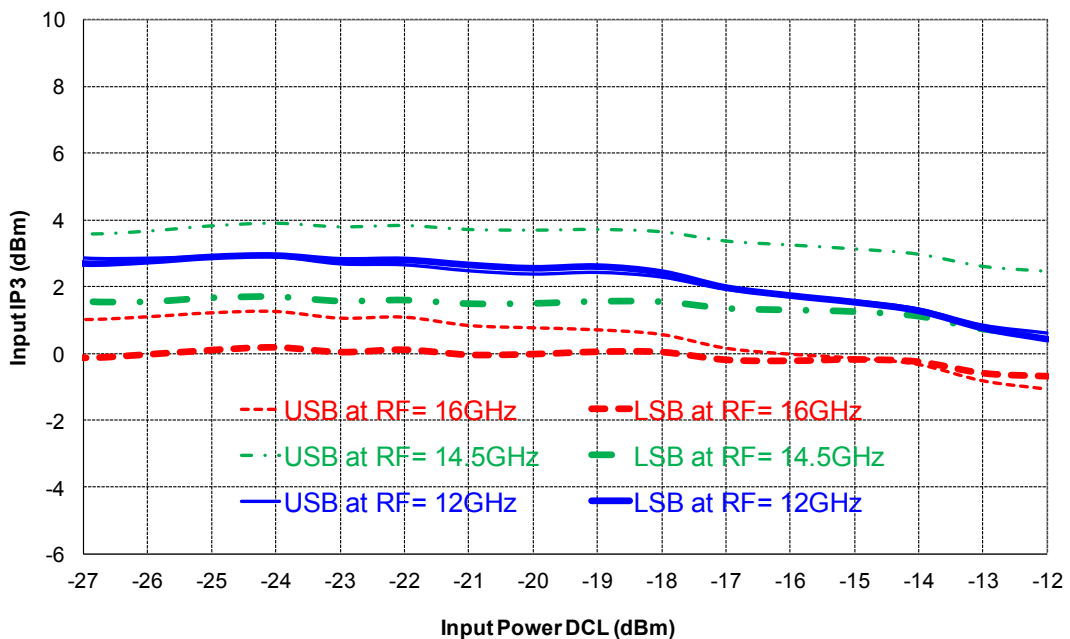

Typical Board Measurements

Tamb.= +25°C, VD1= VD2= VD3= +3V, VG4= -1V, P_LO = +5dBm

Conversion Gain versus temperature at IF = 1GHz
(USB & LSB modes)

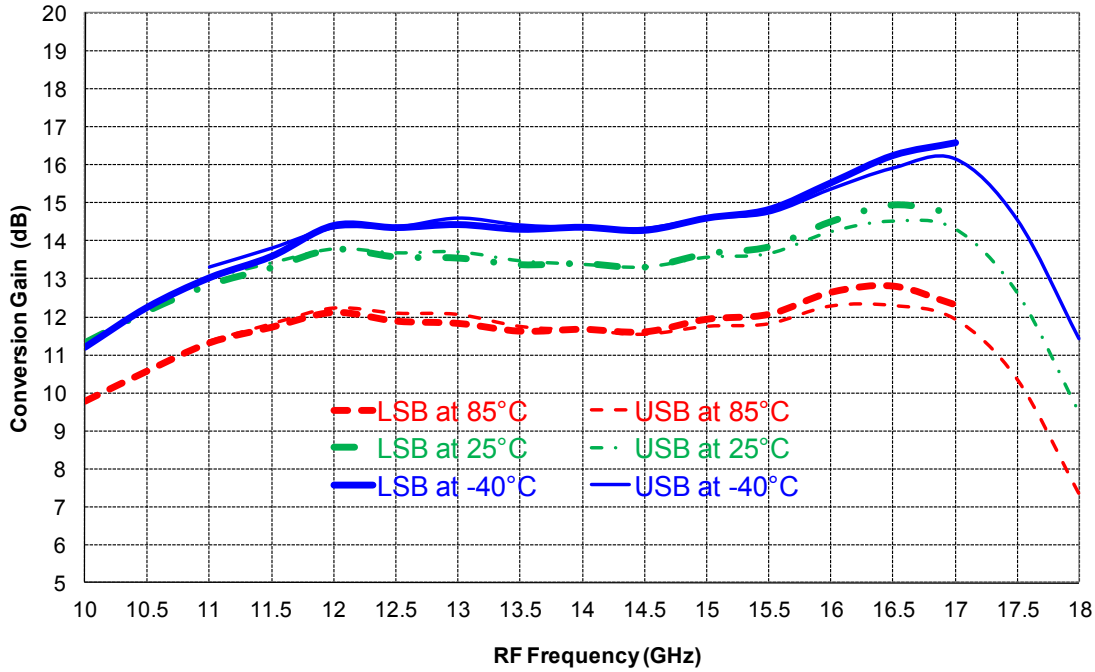

Conversion Gain versus temperature at IF = 3.5GHz
(USB & LSB modes)

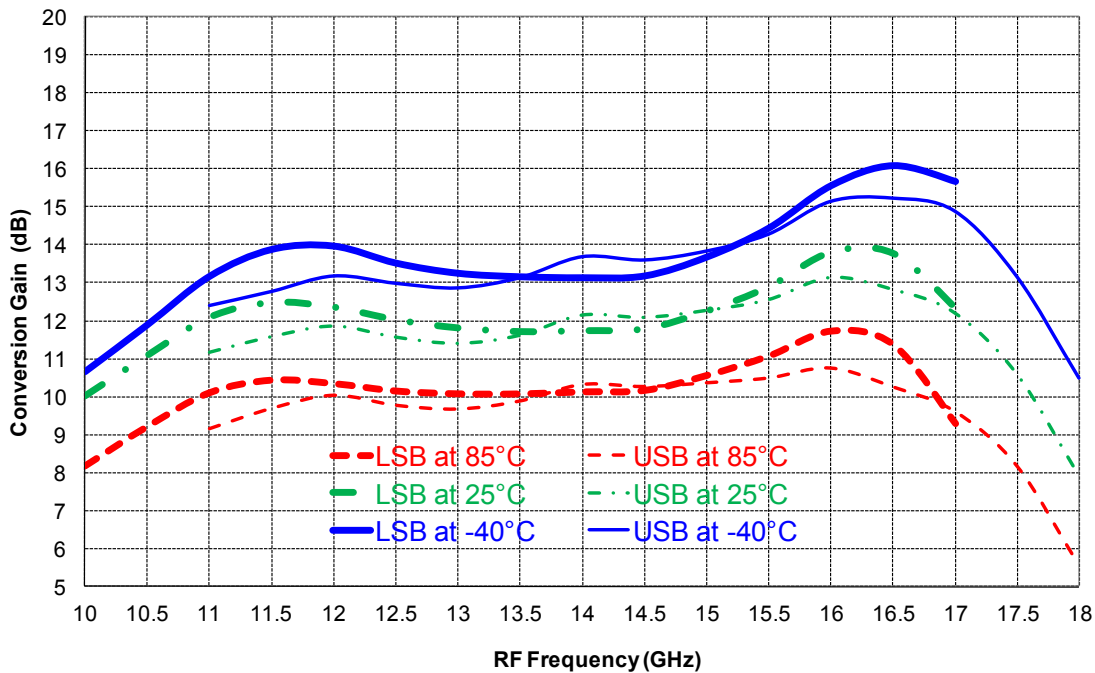

Typical Board Measurements

Tamb.= +25°C, VD1= VD2= VD3= +3V, VG4= -1V, P_LO = +5dBm

**Noise Figure versus temperature at IF = 3.5GHz
(USB mode)**

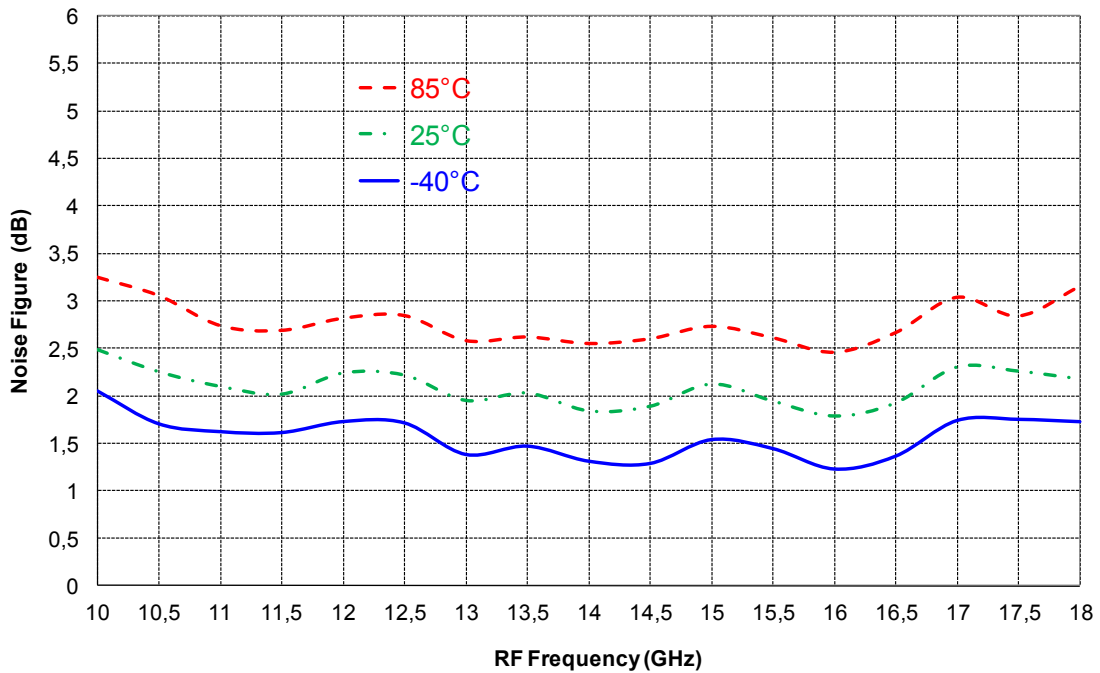

**Input IP3 versus temperature at IF = 2GHz
(USB & LSB modes – RF = -20dBm DCL)**

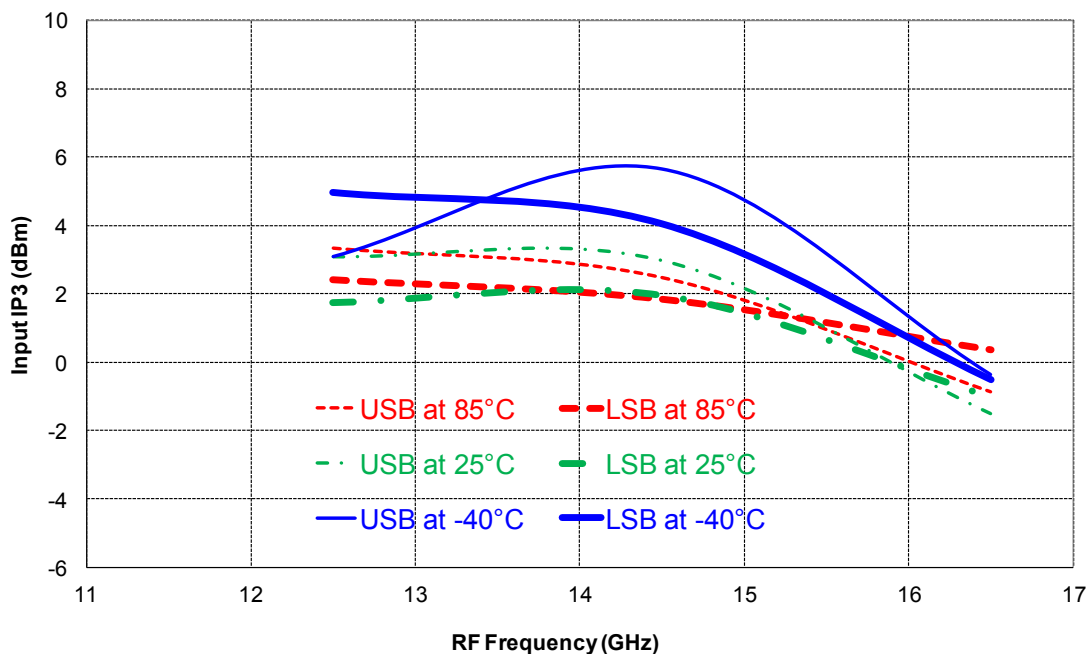

Typical Board Measurements

Tamb.= +25°C, VD1= VD2= VD3= +3V, VG4= -1V, P_LO = +5dBm

Input IP3 versus temperature at RF = 14.5GHz
(USB & LSB modes – RF = -20dBm DCL)

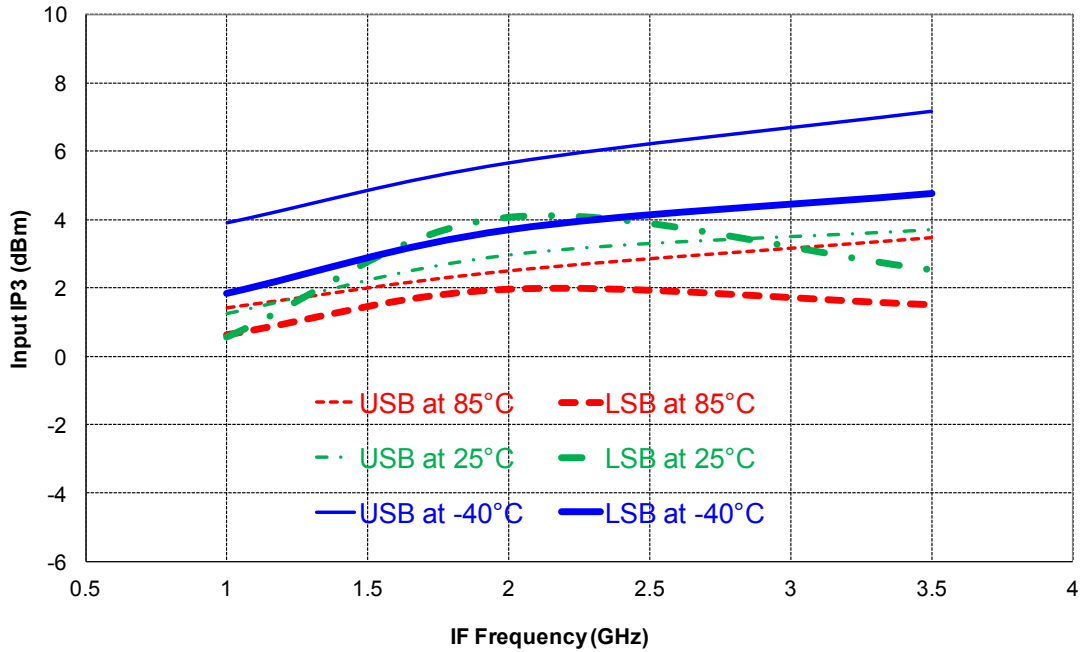

Return Loss LO & RF

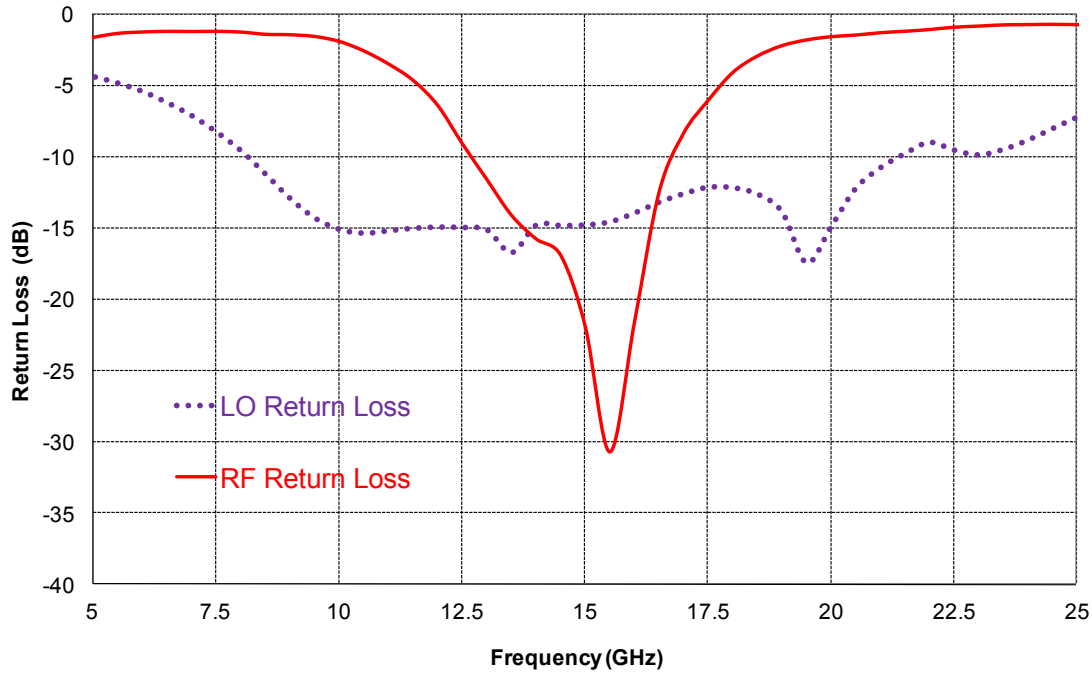

Typical Board Measurements

Tamb.= +25°C, VD1= VD2= VD3= +3V, VG4= -1V, P_LO = +5dBm

Spurious on IF outputs

$$RF = LO + IF$$

$$P_{RF} = -20\text{dBm @ } 14.5\text{GHz} / P_{LO} = +5\text{dBm @ } 12.5\text{GHz}$$

mRF	nLO				
	0	1	2	3	4
0	xx	13	27	47	>90
1	23	0	38	44	>90
2	>90	60	29	50	58
3	>90	>90	>90	53	>90
4	>90	>90	>90	>90	>90

All values in dBc below IF power level (IF = 2GHz).
Data measured without external hybrid coupler.

Definition of the package access planes

The package access planes are symmetrical from the axis of the package (see drawing beside). The input and output reference planes are located at 3.18mm offset (input wise and output wise respectively) from this axis.

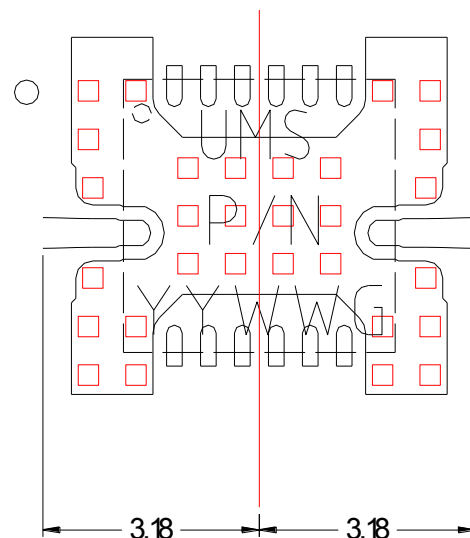

Package outline ⁽¹⁾

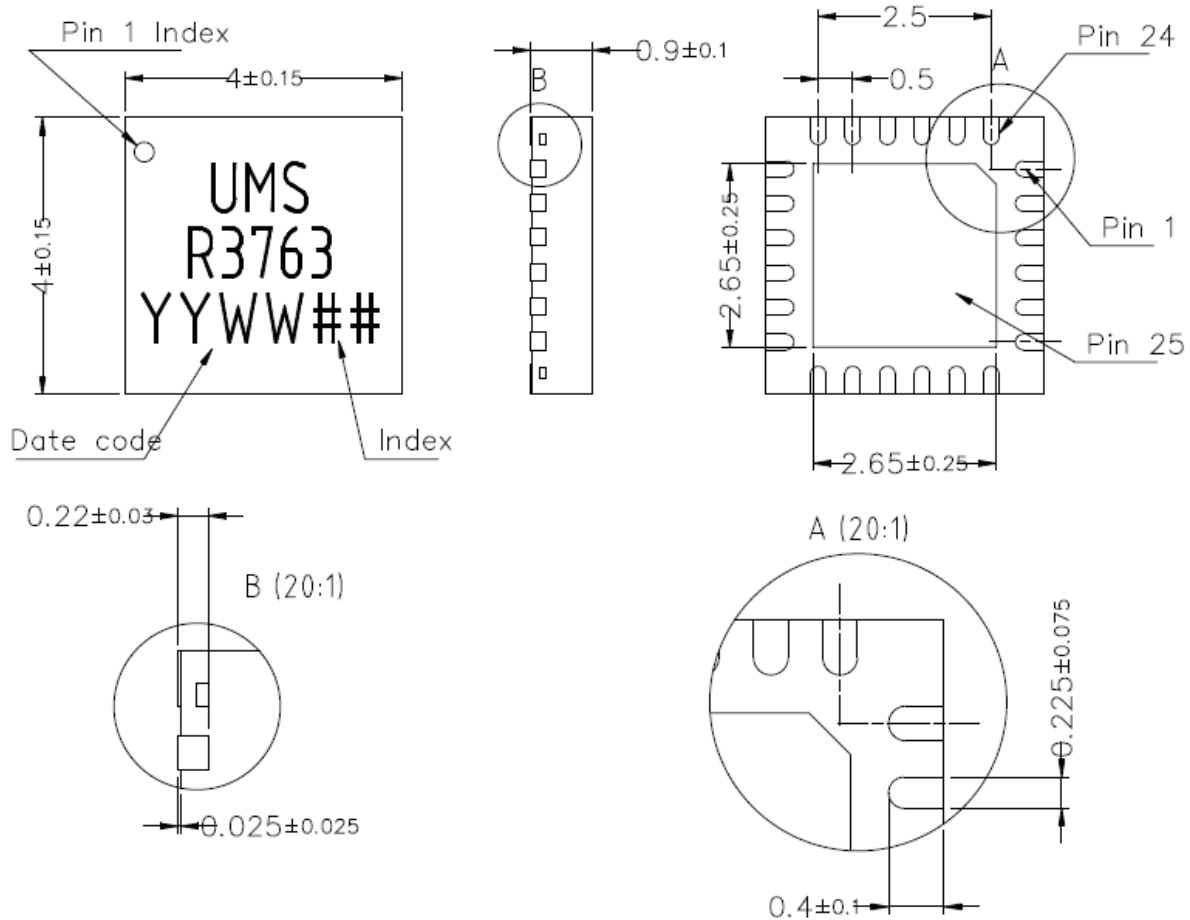

Matt tin, Lead Free	(Green)	1- Nc	9- RF in	17- VG4
Units :	mm	2- IF_Q	10- Gnd ⁽²⁾	18- VD3
From the standard :	JEDEC MO-220	3- Gnd ⁽²⁾	11- Nc	19- VG3
	(VGGD)	4- Gnd ⁽²⁾	12- VG1	20- Nc
	25- GND	5- IF_I	13- VD1	21- Gnd ⁽²⁾
		6- Nc	14- VG2	22- LO in
		7- Nc	15- VD2	23- Gnd ⁽²⁾
		8- Gnd ⁽²⁾	16- Nc	24- Nc

⁽¹⁾ The package outline drawing included in this data-sheet is given for indication. Refer to the application note AN0017 (<http://www.ums-gaas.com>) for exact package dimensions.

⁽²⁾ It is strongly recommended to ground all pins marked "Gnd" through the PCB board. Ensure that the PCB board is designed to provide the best possible ground to the package.

Evaluation mother board

- Compatible with the proposed footprint.
- Based on typically Ro4003 / 8mils or equivalent.
- Using a micro-strip to coplanar transition to access the package.
- Recommended for implementation of this product on a module board.
- Decoupling capacitors of 100pF $\pm 5\%$ and 10nF $\pm 10\%$ are recommended for all DC accesses.
- See application note AN0017 for details.
- Hybrid coupler 90° for 1-2GHz or 2-4GHz.

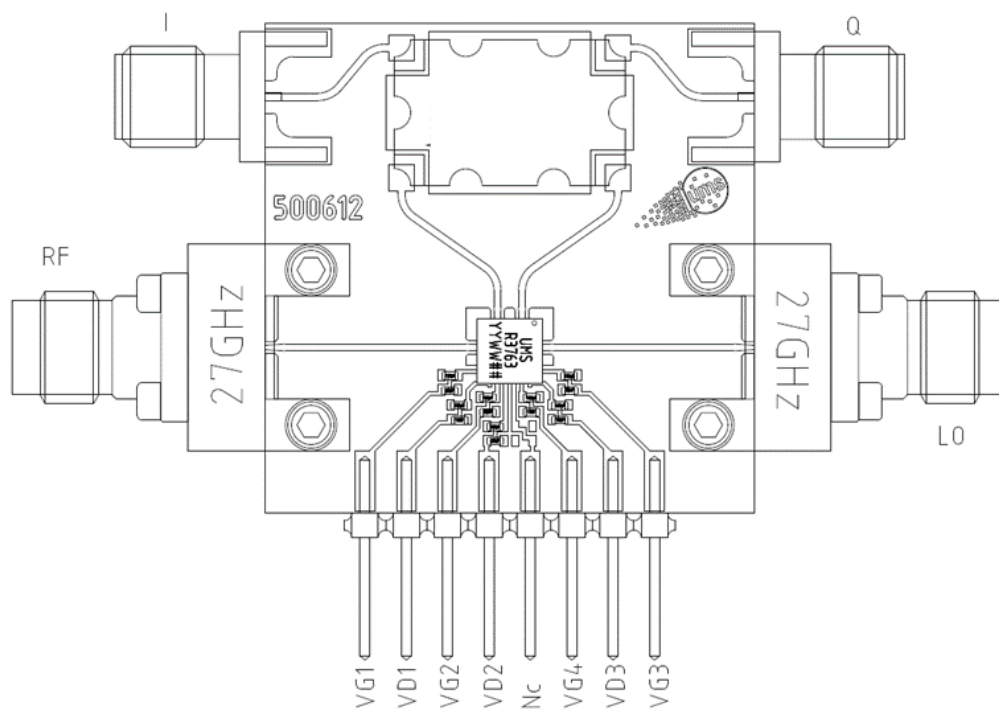

Notes

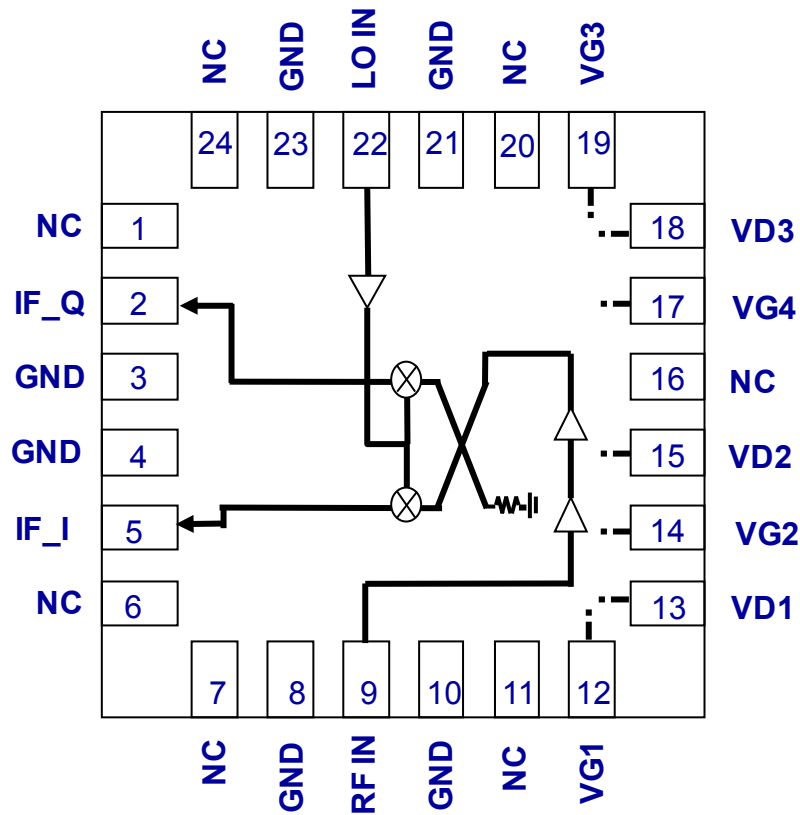

ESD protections are implemented on gate DC bias accesses and RF input.

The DC connections do not include any decoupling capacitor in package, therefore it is mandatory to provide a good external DC decoupling (100pF + 10nF) on the PC board, as close as possible to the package.

DC Schematic

LNA: 3V, 45mA

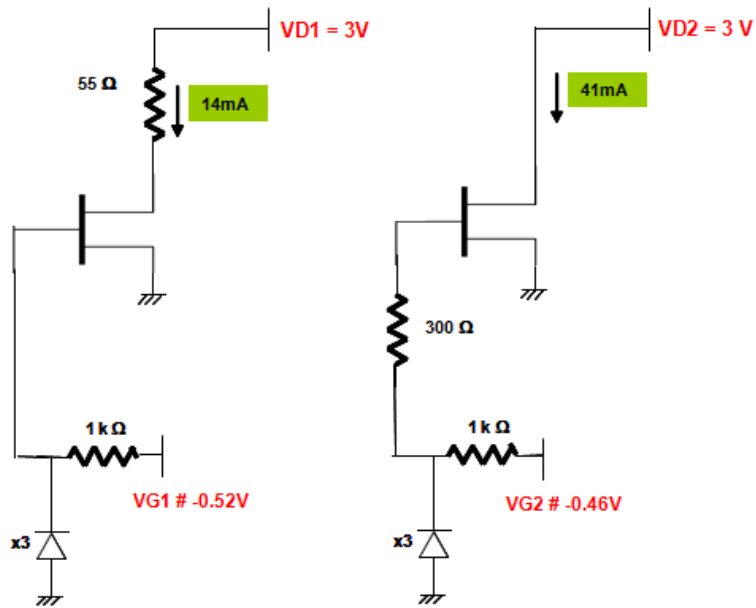

LO Buffer: 3V, 35mA

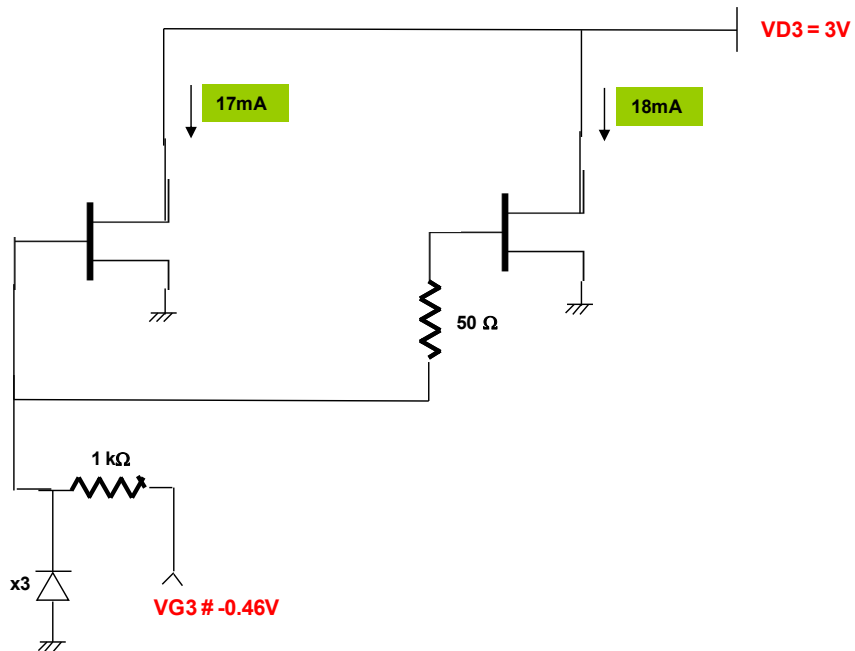

Recommended package footprint

Refer to the application note AN0017 available at <http://www.ums-gaas.com> for package footprint recommendations.

SMD mounting procedure

For the mounting process standard techniques involving solder paste and a suitable reflow process can be used. For further details, see application note AN0017.

Recommended environmental management

UMS products are compliant with the regulation in particular with the directives RoHS N°2011/65 and REACH N°1907/2006. More environmental data are available in the application note AN0019 also available at <http://www.ums-gaas.com>.

Recommended ESD management

Refer to the application note AN0020 available at <http://www.ums-gaas.com> for ESD sensitivity and handling recommendations for the UMS package products.

Ordering Information

QFN 4x4 package:

CHR3763-QDG/XY

Stick: XY = 20

Tape & reel: XY = 21

Information furnished is believed to be accurate and reliable. However **United Monolithic Semiconductors S.A.S.** assumes no responsibility for the consequences of use of such information nor for any infringement of patents or other rights of third parties which may result from its use. No license is granted by implication or otherwise under any patent or patent rights of **United Monolithic Semiconductors S.A.S.** Specifications mentioned in this publication are subject to change without notice. This publication supersedes and replaces all information previously supplied. **United Monolithic Semiconductors S.A.S.** products are not authorised for use as critical components in life support devices or systems without express written approval from **United Monolithic Semiconductors S.A.S.**

X-ON Electronics

Largest Supplier of Electrical and Electronic Components

Click to view similar products for [Up-Down Converters](#) category:

Click to view products by [United Monolithic Semiconductors](#) manufacturer:

Other Similar products are found below :

[HMC7586-SX](#) [HMC8120-SX](#) [HMC8121-SX](#) [HMC7587](#) [HMC8118](#) [HMC8118-SX](#) [HMC7587-SX](#) [MAX2680AUT+T](#) [MAX9996ETP+T](#)
[ADMV4530ACCZ](#) [F1102NBGI8](#) [HMC6147ALC5ATR](#) [MDS-158-PIN](#) [LA8153QA-WH](#) [HMC7912LP5ETR](#) [HMC377QS16GETR](#)
[HMC1090LP3ETR](#) [F1162NBGI](#) [F1178NBGI](#) [MD-123-PIN](#) [ADRF6780ACPZN-R7](#) [MAX9993ETP+](#) [MAX9996ETP+](#) [SM5T](#) [SKY73062-11](#)
[MAX2680EUT+T](#) [MAX2671EUT+T](#) [MAX19997AETX+](#) [MAX19993ETX+](#) [MAX19985AETX+](#) [MAMXSS0012TR-3000](#) [MY63C](#) [MY87C](#)
[M2A](#) [CSM2-10](#) [CSM1-13](#) [CHR3762-QDG](#) [MAX2671EUT-T](#) [MAX19994AETX+](#) [MAX2663EUT+T](#) [MAX19999ETX+](#) [MAX19995ETX+](#)
[TGC4408-SM](#) [TGC4510-SM](#) [TGC4610-SM](#) [TGC4407-SM](#) [TGC2510-SM](#) [MY63H](#) [HMC904LC5TR](#) [ADRF6658BCPZ-RL7](#)