

REACH & RoHS
COMPLIANT

REV.	ECN / DESCRIPTION	BY	DATE
A0	NEW	ZG.Hu	2018.03.03

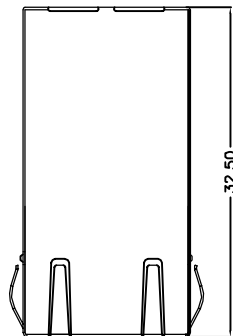

TOP VIEW

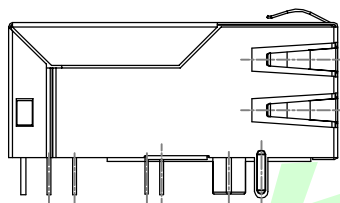

LEFT SIDE VIEW

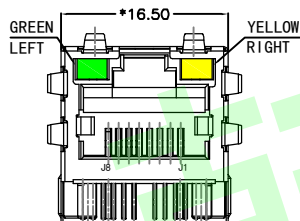

FRONT VIEW

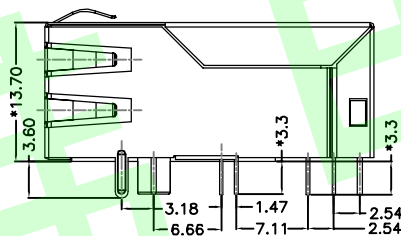

RIGHT SIDE VIEW

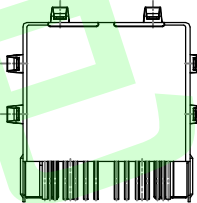

BACK VIEW

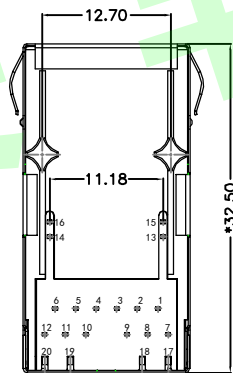

BOTTOM VIEW

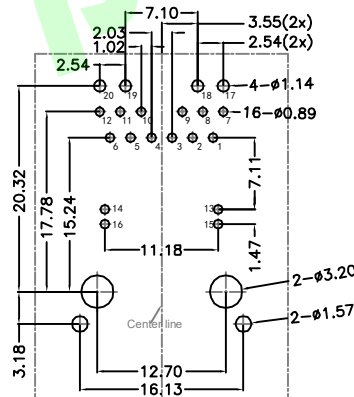

RECOMMENDED PCB LAYOUT
VIEWED FROM COMPONENT SIDE

MATERIAL:

HOUSING: PBT,UL94V-0,BLACK.
TERMINALS BRACKET: PBT,UL94V-0,BLACK.
SHIELD: C2680,T=0.20MM,NICKEL PLATING ON ALL AREA.
TERMINAL: PHOSPHOR BRONZE C5210,T=0.35MM,
6U" GOLD PLATING ON CONTACT AREA.

MECHANICAL:

DURABILITY: 750 CYCLES MIN.
MATING FORCE: 23N MAX.
OPERATING TEMPERATURE: -40°C~+85°C.
STORAGE TEMPERATURE: -40°C~+85°C.
ALL CRITICAL DIMENSIONS WITH "*"



东莞市美韩电子科技有限公司

Dongguan Usakro Electronic Technology Co., Ltd.

Tel : 0769-87869902

http://www.usakro.com

TITLE:
TAB-UP 10/100/1000BASE POE+
PART NO.:
DGUK411Q199DB2A1DP
REMARK:

SIZE
A4
SCALE
1:1
SHEET
1/4

UNITS
MM[INCH]
REV
A0



GENERAL TOLERANCES
UNLESS SPECIFIED

$x \pm 0.35$	$x^\circ \pm 3.0^\circ$
$.x \pm 0.30$	$.x^\circ \pm 2.0^\circ$
$.xx \pm 0.25$	$.xx^\circ \pm 1.5^\circ$
$.xxx \pm 0.10$	$.xxx^\circ \pm 1.0^\circ$

APPROVED BY:
JP.Gong
CHECKED BY:
TW.Xu
DESIGND BY:
ZG.Hu

REACH & RoHS
COMPLIANT

REV.	ECN / DESCRIPTION	BY	DATE
A0	NEW	ZG.Hu	2018.03.03

Suggested Panel Opening:

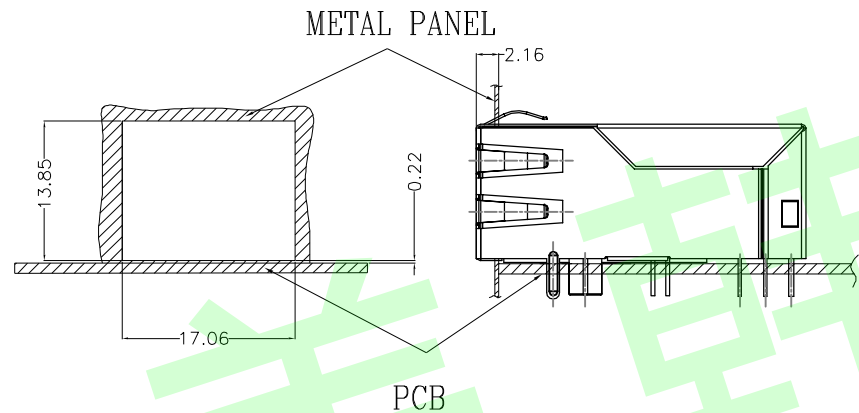

UNIT: mm / inch
Tolerances: ± 0.10 / 0.004

Keep-Out Area (Component Side View):

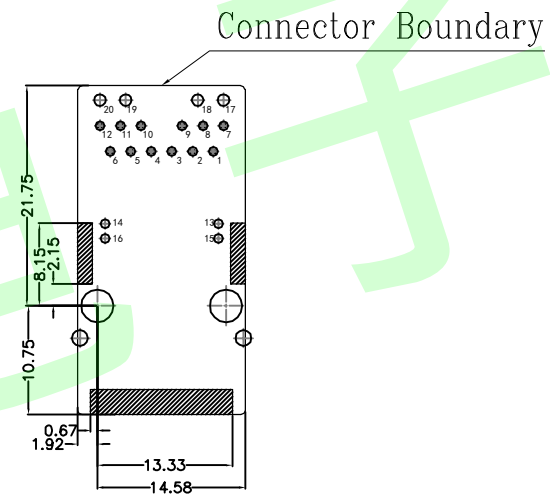

Plug-in side

UNIT: mm / inch
Tolerances: ± 0.10 / 0.004



东莞市美韩电子科技有限公司

Dongguan Usakro Electronic Technology Co., Ltd

Tel : 0769-87869902

<http://www.usakro.com>

TITLE:
TAB-UP 10/100/1000BASE POE+

PART NO.:
DGUK411Q199DB2A1DP

REMARK:

SIZE
A4

SACLE
1:1

SHEET
2/4

UNITS
MM[INCH]

REV
A0

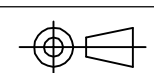

GENERAL TOLERANCES
UNLESS SPECIFIED

$x \pm 0.35$
 $x \pm 0.30$
 $.xx \pm 0.25$
 $.xxx \pm 0.10$

$x^\circ \pm 3.0^\circ$
 $.x^\circ \pm 2.0^\circ$
 $.xx^\circ \pm 1.5^\circ$
 $.xxx^\circ \pm 1.0^\circ$

APPROVED BY:
JP.Gong

CHECKED BY:
TW.Xu

DESIGND BY:
ZG.Hu

REACH & RoHS
COMPLIANT

REV.	ECN / DESCRIPTION	BY	DATE
A0	NEW	ZG.Hu	2018.03.03

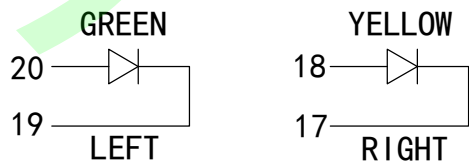
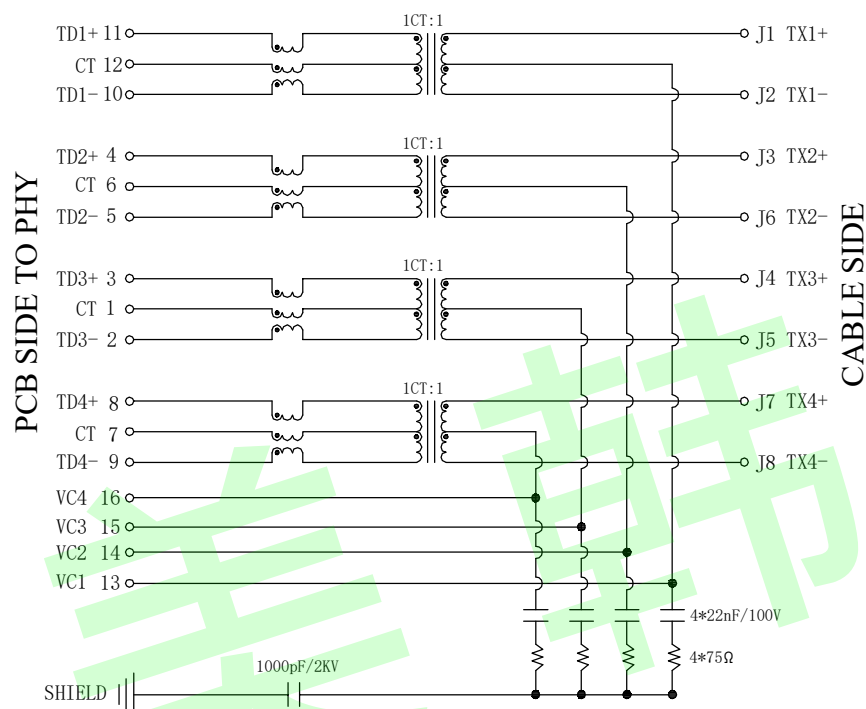

Electrical:

- Turn ratio: 11~10:J1~J2=1CT:1CT(±2%).
4~5:J3~J6=1CT:1CT(±2%).
3~2:J4~J5=1CT:1CT(±2%).
8~9:J7~J8=1CT:1CT(±2%).
- OCL: 350uH Min. @ 100KHz 100mV
RMS(4Channel) 15mA DC BIAS.
- Insertion Loss: -1.0 dB Max 1~100MHz.
- Return loss: -18dB Min 1~30MHz;
-14dB Min 30~60MHz.
-12dB Min 60~80MHz.
-10dB Min 80~100MHz.
- Cross talk: -40dB Min 1~30MHz;
-35dB Min 30~60MHz;
-30dB Min 60~100MHz;
- CMR: -30dB Min 1~100MHz;
- Hi-Pot: 2250V DC 6S 1mA PRI TO SEC
- Single port magnetic jack POE magnetics acc.
To IEEE802.3at for PSE or PD applications.
- 100% of production tested to comply with
IEEE 802.3 isolation requirements balanced DC
line current 720mA max. 57V DC continuous.

LED Specification

Standard LED Color	LED Wavelength	Foward(A)	Foward(V)
Green	568nm	20mA	1.85-2.45V
Yellow	585nm	20mA	1.7-2.2V
Orange	585nm	20mA	1.8-2.8V



东莞市美韩电子科技有限公司
Dongguan Usakro Electronic Technology Co., Ltd.
Tel : 0769-87869902 http://www.usakro.com

TITLE: TAB-UP 10/100/1000BASE POE+	SIZE A4	UNITS MM[INCH]	GENERAL TOLERANCES UNLESS SPECIFIED		APPROVED BY: JP.Gong
PART NO.: DGUK411Q199DB2A1DP	SACLE 1:1	REV A0	x±0.35 .x±0.30	x°±3.0° .x°±2.0°	CHECKED BY: TW.Xu
REMARK:	SHEET 3/4		.xx±0.25 .xxx±0.10	.xx°±1.5° .xxx°±1.0°	DESIGND BY: ZG.Hu

REACH & RoHS
COMPLIANT

PROFILE OF WAVE SOLDER

REV.	ECN / DESCRIPTION	BY	DATE
A0	NEW	ZG.Hu	2018.03.03

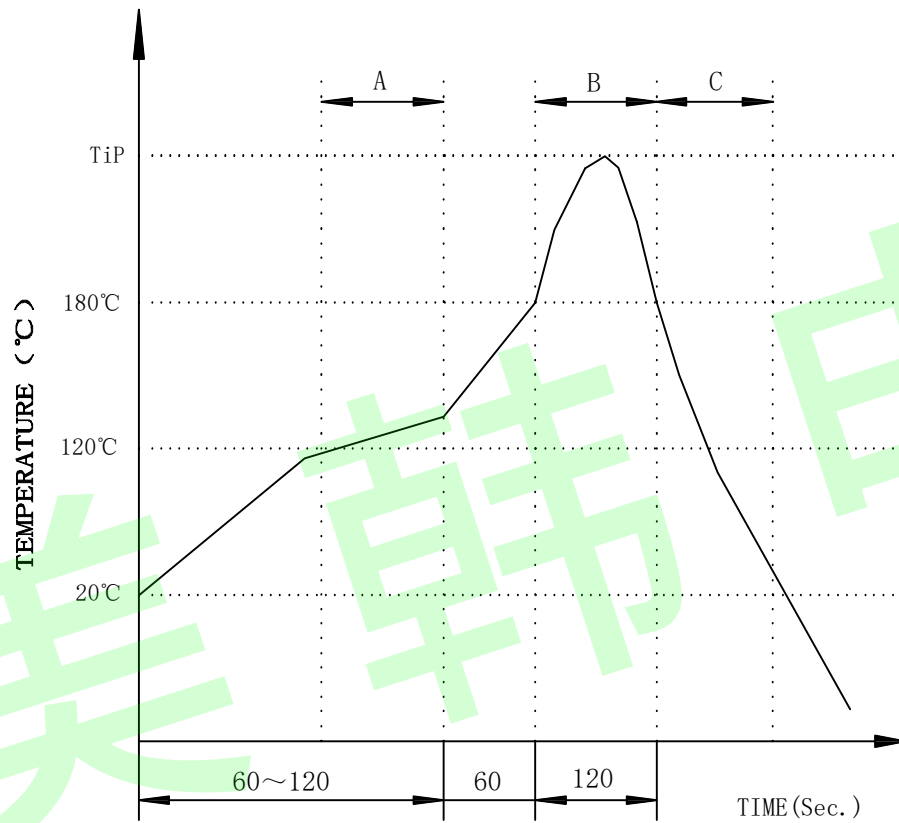

A.Preheating B.Soldering C.Gradual Cooling
 Tip temperature:260±5°C.
 Tip temperature time:5Sec Max.
 Tip melting point of Sn96.5/Ag3/Cu0.5:217°C.

Remarks: after wave soldering, the plastic positioning columns of the product which under the PCB will be slightly melted, but it won't affect its function.



TITLE:
TAB-UP 10/100/1000BASE POE+

SIZE
A4

UNITS
MM[INCH]

GENERAL TOLERANCES
UNLESS SPECIFIED

APPROVED BY:
JP.Gong

PART NO.:
DGUK411Q199DB2A1DP

SACLE
1:1

REV
A0

x±0.35
.x±0.30

x°±3.0°
.x°±2.0°

REMARK:

SHEET
4/4

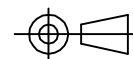

.xx±0.25
.xxx±0.10

DESIGND BY:
ZG.Hu

东莞市美韩电子科技有限公司
 Dongguan Usakro Electronic Technology Co., Ltd.
 Tel : 0769-87869902
<http://www.usakro.com>

X-ON Electronics

Largest Supplier of Electrical and Electronic Components

Click to view similar products for [Modular Connectors](#) / [Ethernet Connectors](#) category:

Click to view products by [USAKRO](#) manufacturer:

Other Similar products are found below :

[8949-H88/06BLKA/SN](#) [74441-0010/BKN](#) [PHP-6P6C-5](#) [GAX-3-66](#) [GDCX-PN-66](#) [GLX-A-44](#) [GLX-N-1010M-BLK](#) [GLX-S-88M-BLK](#)
[GMX-SMT4-N-88](#) [GSGX-N-2-88](#) [GSGX-N-4-88](#) [GSX-NS2-88-3.05](#) [GSX-NS-88-3.68](#) [PT-108A-8C-UL](#) [PTS-J531-8CS-50UL](#) [A-2014-0-4](#)
[GWLX-S9-88-YG](#) [DC-1021-8-WH-6](#) [1300530003](#) [1324640-4](#) [132764-001](#) [1413235](#) [MPS88RX-5000](#) [E5288-S000K3-L](#) [155302-001](#)
[AX101050](#) [AX101063](#) [AX101065](#) [AX101072](#) [AX101307](#) [AX101315](#) [AX101318](#) [AX102271](#) [AX102277](#) [AX102651](#) [AX102660](#) [AX104024](#)
[203475](#) [PC4D0018P](#) [KIT38082NI](#) [8949-B88/6](#) [2-6609208-5](#) [30-8956](#) [30-8964-100](#) [SM85](#) [SM99S01VBNN04G7](#) [17-103540](#) [191587](#) [PDI-68-RV](#) [PHP-8P8C-S-5](#)