

Features

- P-Channel, -5V Logic Level Control
- Low on-resistance RDS(on) @ VGS=-4.5 V
- Fast Switching
- Enhancement mode
- Pb-free lead plating; RoHS compliant

V_{DS}	-30	V
$R_{DS(on),TYP} @ V_{GS}=-10 V$	22	mΩ
$R_{DS(on),TYP} @ V_{GS}=-4.5V$	39	mΩ
I_D	-27	A

PDFN3333

Part ID	Package Type	Marking	Tape and reel information
VS3522AE	PDFN3333	3522AE	5000pcs/Reel

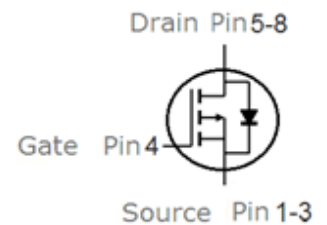

Maximum ratings, at T_A =25°C, unless otherwise specified

Symbol	Parameter	Rating	Unit	
$V_{(BR)DSS}$	Drain-Source breakdown voltage	-30	V	
I_S	Diode continuous forward current	$T_C=25^\circ C$	-27	A
I_D	Continuous drain current @ VGS=-10V	$T_C=25^\circ C$	-27	A
		$T_C=100^\circ C$	-17	A
I_{DM}	Pulse drain current tested ①	$T_C=25^\circ C$	-108	A
EAS	Avalanche energy, single pulsed ②	20	mJ	
P_D	Maximum power dissipation	$T_C=25^\circ C$	29	W
VGS	Gate-Source voltage	±20	V	
$T_{STG} T_J$	Storage and operating temperature range	-55 to 150	°C	

Thermal Characteristics

Symbol	Parameter	Typical	Unit
$R_{\theta JC}$	Thermal Resistance-Junction to Case	4.3	°C/W
$R_{\theta JA}$	Thermal Resistance-Junction to Ambient	35	°C/W

Symbol	Parameter	Condition	Min.	Typ.	Max.	Unit
Static Electrical Characteristics @ T_j = 25°C (unless otherwise stated)						
V _{(BR)DSS}	Drain-Source Breakdown Voltage	V _{GS} =0V, I _D =-250μA	-30	--	--	V
I _{DSS}	Zero Gate Voltage Drain Current	V _{DS} =-30V, V _{GS} =0V	--	--	-1	μA
	Zero Gate Voltage Drain Current(T _j =125°C)	V _{DS} =-30V, V _{GS} =0V	--	--	-100	μA
I _{GSS}	Gate-Body Leakage Current	V _{GS} =±20V, V _{DS} =0V	--	--	±100	nA
V _{GS(TH)}	Gate Threshold Voltage	V _{DS} =V _{GS} , I _D =-250μA	-1.3	-1.9	-2.4	V
R _{DS(ON)}	Drain-Source On-State Resistance ③	V _{GS} =-10V, I _D =-20A	--	22	27	mΩ
R _{DS(ON)}	Drain-Source On-State Resistance ③	V _{GS} =-4.5V, I _D =-10A	--	39	49	mΩ
Dynamic Electrical Characteristics @ T_j = 25°C (unless otherwise stated)						
C _{iss}	Input Capacitance	V _{DS} =-15V, V _{GS} =0V, f=1MHz	--	850	--	pF
C _{oss}	Output Capacitance		--	140	--	pF
C _{rss}	Reverse Transfer Capacitance		--	95	--	pF
R _g	Gate Resistance	f=1MHz	--	9.8	--	Ω
Q _g	Total Gate Charge	V _{DS} =-15V, I _D =-20A, V _{GS} =-10V	--	19	--	nC
Q _{gs}	Gate-Source Charge		--	4.3	--	nC
Q _{gd}	Gate-Drain Charge		--	6.5	--	nC
Switching Characteristics						
t _{d(on)}	Turn-on Delay Time	V _{DD} =-15V, I _D =-20A, R _G =3Ω, V _{GS} =-10V	--	6	--	nS
t _r	Turn-on Rise Time		--	5	--	nS
t _{d(off)}	Turn-Off Delay Time		--	25	--	uS
t _f	Turn-Off Fall Time		--	7	--	uS
Source- Drain Diode Characteristics @ T_j = 25°C (unless otherwise stated)						
V _{SD}	Forward on voltage	I _{SD} =-20A, V _{GS} =0V	--	-1	-1.2	V
t _{rr}	Reverse Recovery Time	T _j =25°C, I _{sd} =-20A, V _{GS} =0V	--	7	--	nS
Q _{rr}	Reverse Recovery Charge	di/dt=-500A/μs		6.3	--	nC

NOTE:

- ① Repetitive rating; pulse width limited by max. junction temperature.
- ② Limited by T_{Jmax}, starting T_J = 25°C, L = 0.5mH, R_G = 25Ω, I_{AS} = -9A, V_{GS} = -10V. Part not recommended for use above this value
- ③ Pulse width ≤ 300μs; duty cycle ≤ 2%.

Typical Characteristics

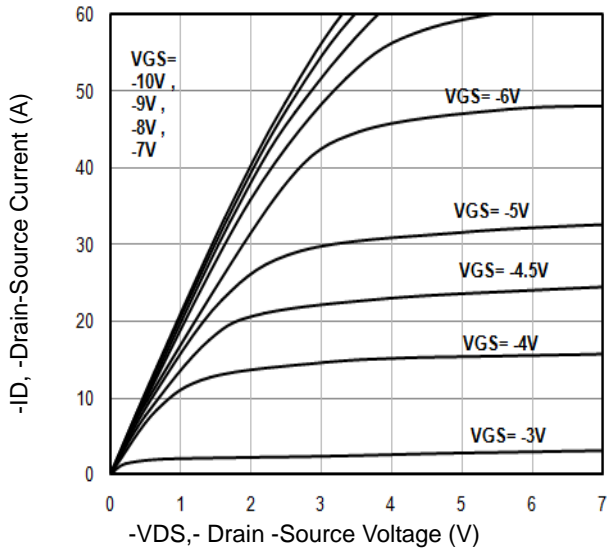

Fig1. Typical Output Characteristics

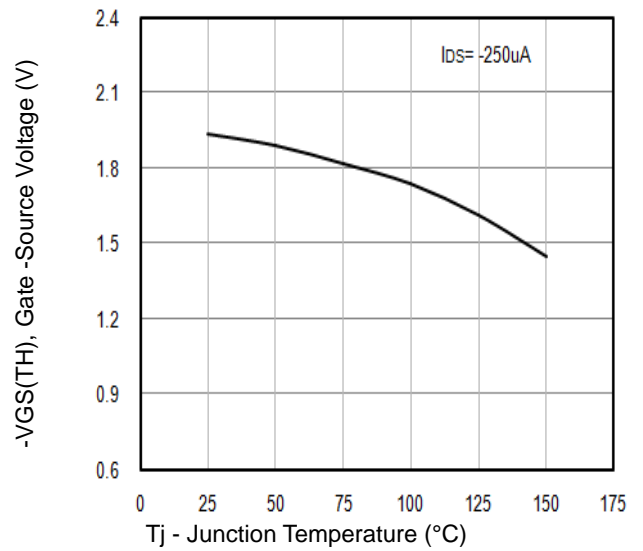

Fig2. $-V_{GS(TH)}$ Gate -Source Voltage Vs. T_j

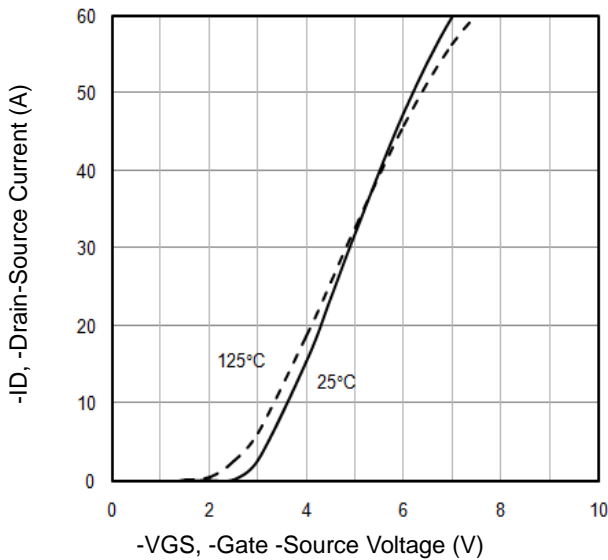

Fig3. Typical Transfer Characteristics

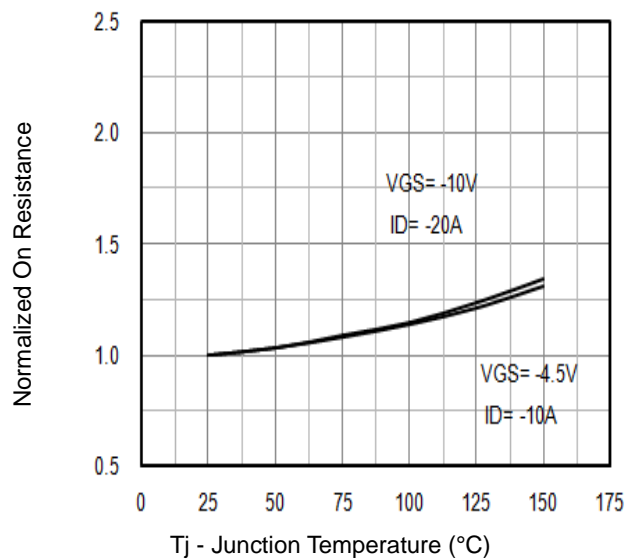

Fig4. Normalized On-Resistance Vs. T_j

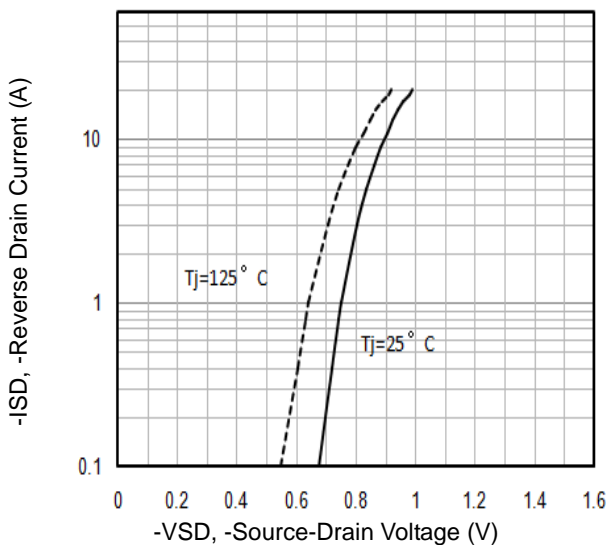

Fig5. Typical Source-Drain Diode Forward Voltage

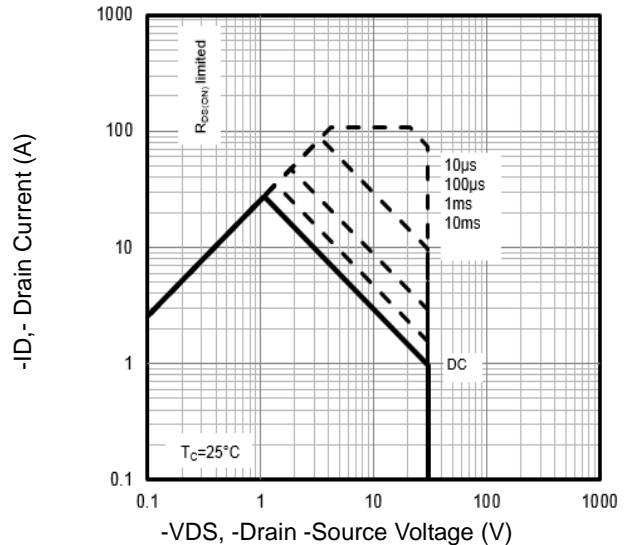

Fig6. Maximum Safe Operating Area

Typical Characteristics

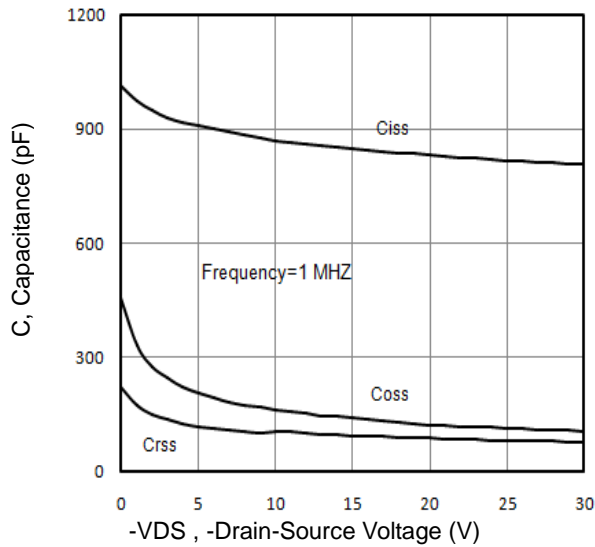

Fig7. Typical Capacitance Vs.Drain-Source Voltage

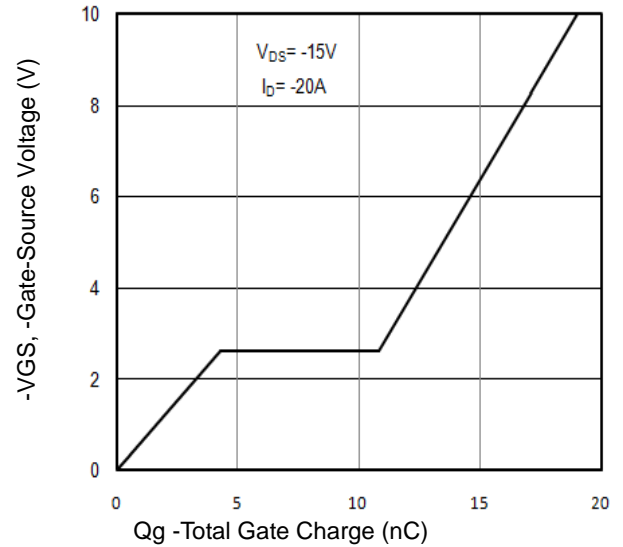

Fig8. Typical Gate Charge Vs.Gate-Source Voltage

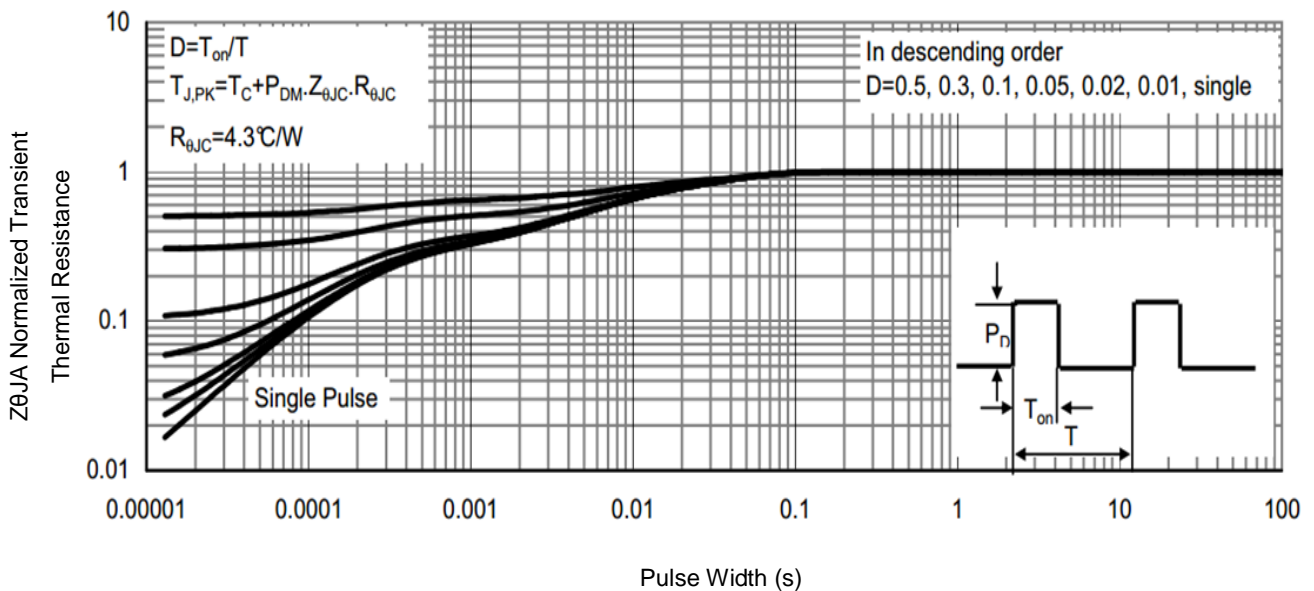

Fig9. Normalized Maximum Transient Thermal Impedance

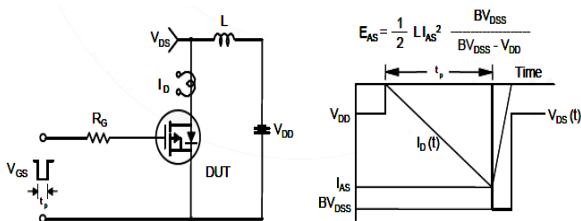

Fig10. Unclamped Inductive Test Circuit and Waveforms

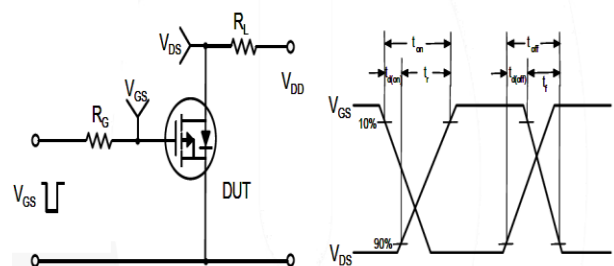
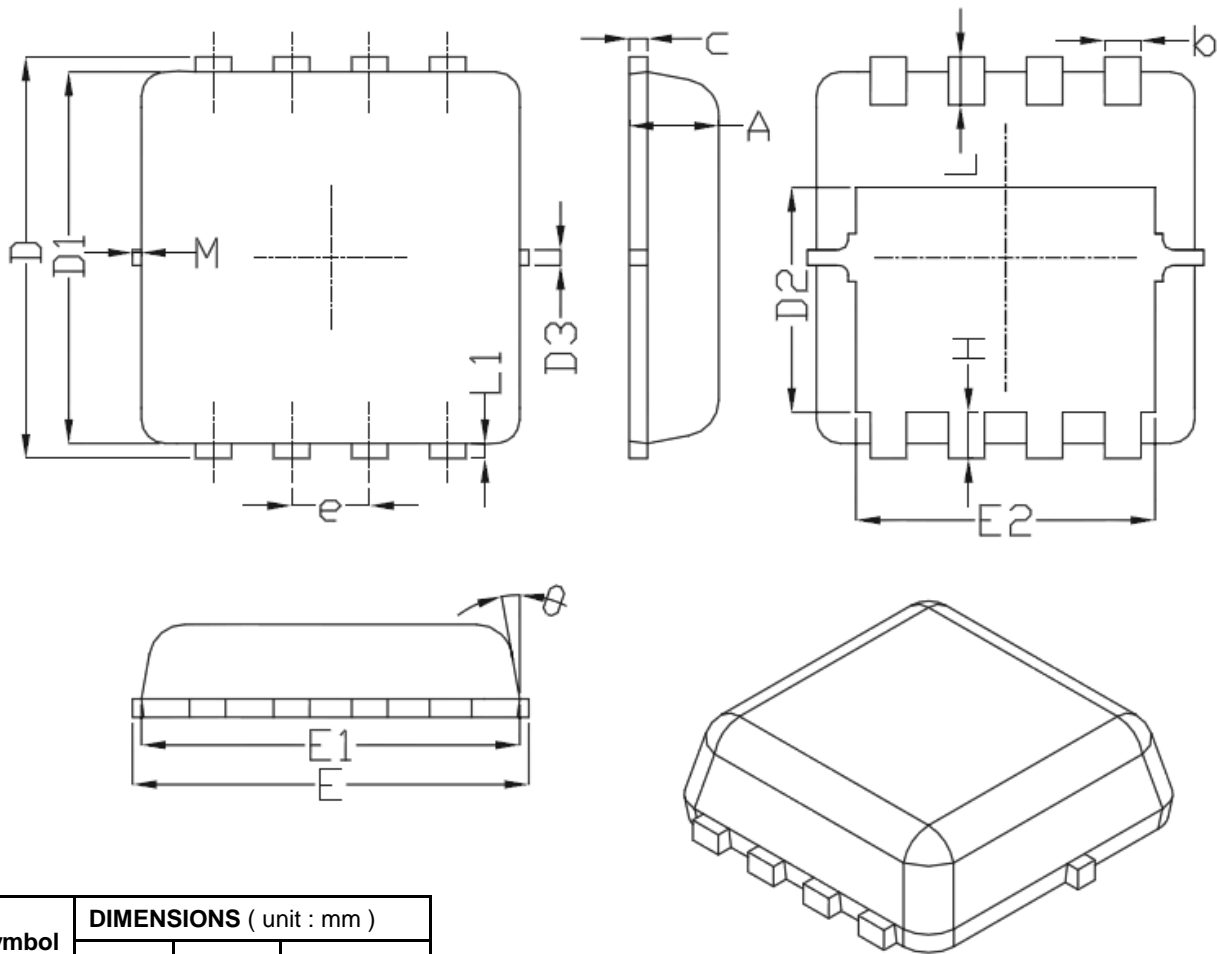

Fig11. Switching Time Test Circuit and waveforms

PDFN3333 Package Outline Data

Symbol	DIMENSIONS (unit : mm)		
	Min	Typ	Max
A	0.7	0.75	0.8
b	0.25	0.3	0.35
C	0.1	0.15	0.25
D	3.25	3.35	3.45
D1	3	3.1	3.2
D2	1.78	1.88	1.98
D3	--	0.13	--
E	3.2	3.3	3.4
E1	3	3.15	3.2
E2	2.39	2.49	2.59
e	0.65 BSC		
H	0.3	0.39	0.5
L	0.3	0.4	0.5
L1	--	0.13	--
θ	--	10°	12°
M	*	*	0.15
* Not specified			

Notes:

1. Follow JEDEC MO-240 variation CA.
2. Dimensions "D1" and "E1" do NOT include mold flash protrusions or gate burrs.
3. Dimensions "D1" and "E1" include interterminal flash or protrusion. Interterminal flash or protrusion shall not exceed 0.25mm per side.

Customer Service
Sales and Service:
sales@vgsemi.com
Vanguard Semiconductor CO., LTD
TEL: (86-755) -26902410

FAX: (86-755) -26907027

WEB: www.vgsemi.com

X-ON Electronics

Largest Supplier of Electrical and Electronic Components

Click to view similar products for [MOSFET](#) category:

Click to view products by [Vanguard](#) manufacturer:

Other Similar products are found below :

[614233C](#) [648584F](#) [MCH3443-TL-E](#) [MCH6422-TL-E](#) [FDPF9N50NZ](#) [FW216A-TL-2W](#) [FW231A-TL-E](#) [APT5010JVR](#) [NTNS3A92PZT5G](#)
[IRF100S201](#) [JANTX2N5237](#) [2SK2464-TL-E](#) [2SK3818-DL-E](#) [FCA20N60_F109](#) [FDZ595PZ](#) [STD6600NT4G](#) [FSS804-TL-E](#) [2SJ277-DL-E](#)
[2SK1691-DL-E](#) [2SK2545\(Q,T\)](#) [D2294UK](#) [405094E](#) [423220D](#) [MCH6646-TL-E](#) [TPCC8103,L1Q\(CM](#) [367-8430-0972-503](#) [VN1206L](#)
[424134F](#) [026935X](#) [051075F](#) [SBVS138LT1G](#) [614234A](#) [715780A](#) [NTNS3166NZT5G](#) [751625C](#) [873612G](#) [IRF7380TRHR](#)
[IPS70R2K0CEAKMA1](#) [RJK60S3DPP-E0#T2](#) [RJK60S5DPK-M0#T0](#) [APT5010JVFR](#) [APT12031JFLL](#) [APT12040JVR](#) [DMN3404LQ-7](#)
[NTE6400](#) [JANTX2N6796U](#) [JANTX2N6784U](#) [JANTXV2N5416U4](#) [SQM110N05-06L-GE3](#) [SIHF35N60E-GE3](#)