

Features

- N-Channel, 5V Logic Level Control
- Enhancement mode
- Very low on-resistance $R_{DS(on)}$ @ $V_{GS}=4.5\text{ V}$
- Fast Switching
- 100% Avalanche test
- Pb-free lead plating; RoHS compliant



Part ID	Package Type	Marking	Tape and reel information
VS3610AE	PDFN3333	3610AE	5000PCS/Reel

V_{DS}	30	V
$R_{DS(on),TYP}@ V_{GS}=10\text{ V}$	4	m Ω
$R_{DS(on),TYP}@ V_{GS}=4.5\text{ V}$	5.7	m Ω
I_D	64	A

PDFN3333

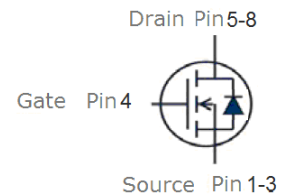
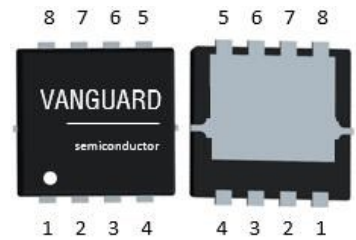

Maximum ratings, at $T_A = 25^\circ\text{C}$, unless otherwise specified

Symbol	Parameter	Rating	Unit
$V_{(BR)DSS}$	Drain-Source breakdown voltage	30	V
I_S	Diode continuous forward current	$T_C = 25^\circ\text{C}$	64 A
I_D	Continuous drain current @ $V_{GS}=10\text{V}$	$T_C = 25^\circ\text{C}$	64 A
		$T_C = 100^\circ\text{C}$	40 A
I_{DM}	Pulse drain current tested ①	$T_C = 25^\circ\text{C}$	256 A
EAS	Avalanche energy, single pulsed ②	49	mJ
P_D	Maximum power dissipation	$T_C = 25^\circ\text{C}$	33 W
V_{GS}	Gate-Source voltage	± 20	V
$T_{STG} T_J$	Storage and operating temperature range	-55 to 150	$^\circ\text{C}$

Thermal Characteristics

Symbol	Parameter	Typical	Unit
$R_{\theta JC}$	Thermal Resistance-Junction to Case	3.8	$^\circ\text{C/W}$
$R_{\theta JA}$	Thermal Resistance Junction-Ambient	35	$^\circ\text{C/W}$



Symbol	Parameter	Condition	Min.	Typ.	Max.	Unit
Static Electrical Characteristics @ T_j=25°C (unless otherwise stated)						
V _{(BR)DSS}	Drain-Source Breakdown Voltage	V _{GS} =0V I _D =250μA	30	--	--	V
I _{DSS}	Zero Gate Voltage Drain Current	V _{DS} =30V, V _{GS} =0V	--	--	0.1	μA
	Zero Gate Voltage Drain Current(T _j =125°C)	V _{DS} =30V, V _{GS} =0V	--	--	100	μA
I _{GSS}	Gate-Body Leakage Current	V _{GS} =±20V, V _{DS} =0V	--	--	±100	nA
V _{GS(TH)}	Gate Threshold Voltage	V _{DS} =V _{GS} , I _D =250μA	1.0	1.7	2.5	V
R _{DS(ON)}	Drain-Source On-State Resistance ^③	V _{GS} =10V, I _D =20A	--	4	5	mΩ
R _{DS(ON)}	Drain-Source On-State Resistance ^③	V _{GS} =4.5V, I _D =16A	--	5.7	7	mΩ
Dynamic Electrical Characteristics @ T_j = 25°C (unless otherwise stated)						
C _{iss}	Input Capacitance	V _{DS} =15V, V _{GS} =0V, f=1MHz	1640	1930	2220	pF
C _{oss}	Output Capacitance		260	310	360	pF
C _{rss}	Reverse Transfer Capacitance		220	260	300	pF
R _g	Gate Resistance	f=1MHz	--	0.85	--	Ω
Q _g (10V)	Total Gate Charge	V _{DS} =15V, I _D =20A, V _{GS} =10V	--	38	--	nC
Q _g (4.5V)	Total Gate Charge		--	22.4	--	nC
Q _{gs}	Gate-Source Charge		--	5.1	--	nC
Q _{gd}	Gate-Drain Charge		--	12	--	nC
Switching Characteristics						
t _{d(on)}	Turn-on Delay Time	V _{DD} =15V, I _D =20A, R _G =3Ω, V _{GS} =10V	--	8.5	--	ns
t _r	Turn-on Rise Time		--	9	--	ns
t _{d(off)}	Turn-Off Delay Time		--	31	--	ns
t _f	Turn-Off Fall Time		--	9	--	ns
Source- Drain Diode Characteristics @ T_j = 25°C (unless otherwise stated)						
V _{SD}	Forward on voltage	I _{SD} =20A, V _{GS} =0V	--	0.8	1.2	V
t _{rr}	Reverse Recovery Time	T _j =25°C, I _{sd} =20A, V _{GS} =0V	--	16	--	ns
Q _{rr}	Reverse Recovery Charge	di/dt=500A/μs		42		nC

NOTE:

- ① Repetitive rating; pulse width limited by max. junction temperature.
- ② Limited by T_{Jmax}, starting T_J = 25°C, L = 0.5mH, R_G = 25Ω, I_{AS} = 14A, V_{GS} = 10V. Part not recommended for use above this value
- ③ Pulse width ≤ 300μs; duty cycle ≤ 2%.

Typical Characteristics

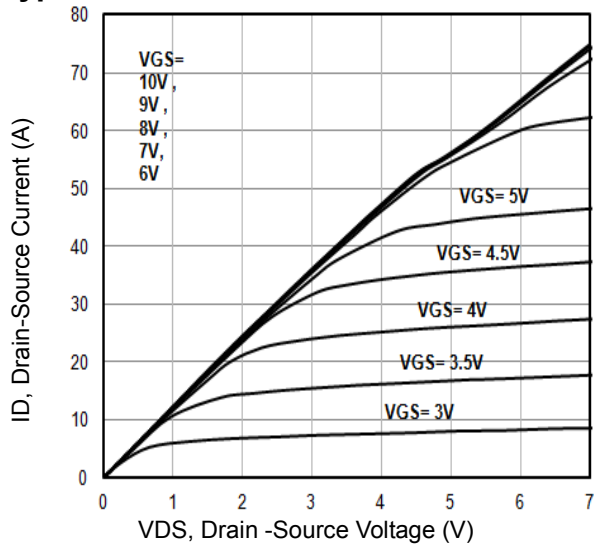

Fig1. Typical Output Characteristics

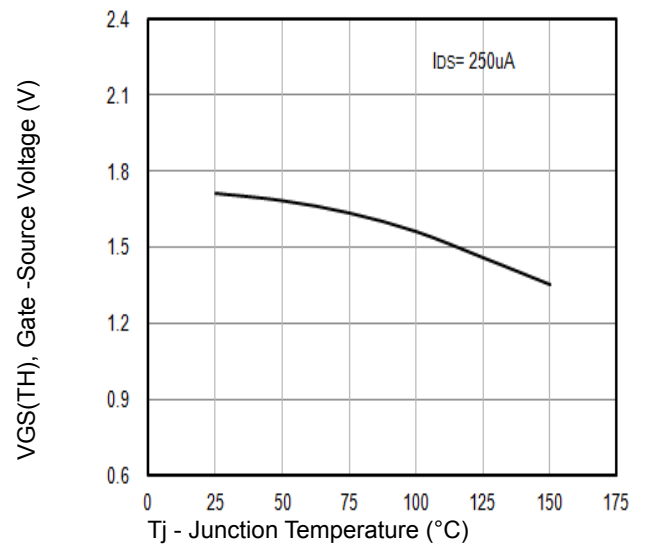

Fig2. $V_{GS(TH)}$ Gate-Source Voltage Vs. T_j

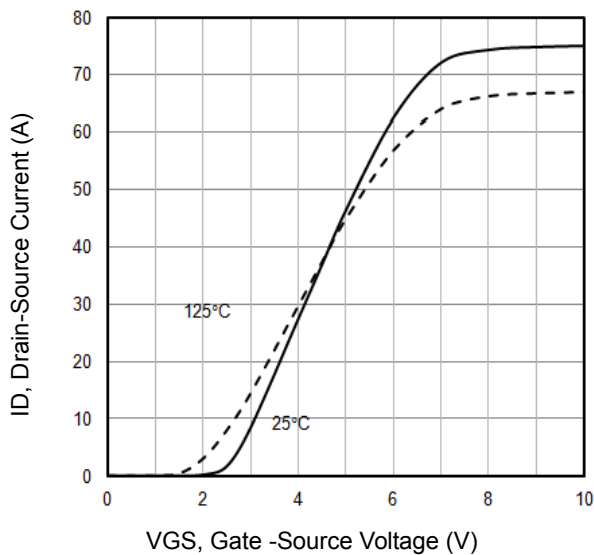

Fig3. Typical Transfer Characteristics

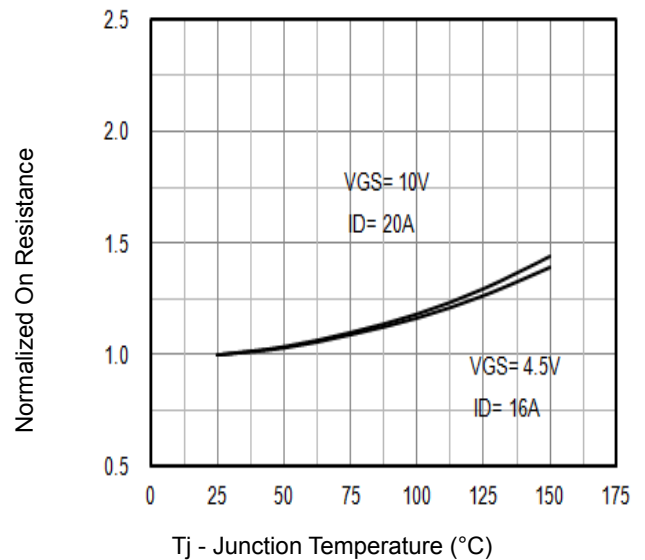

Fig4. Normalized On-Resistance Vs. T_j

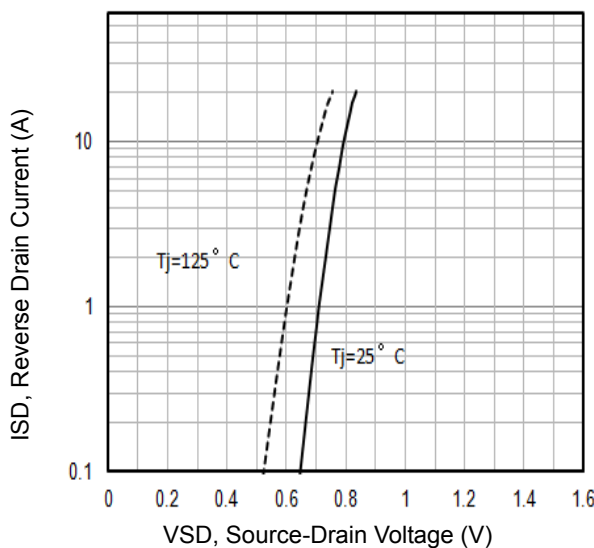

Fig5. Typical Source-Drain Diode Forward Voltage

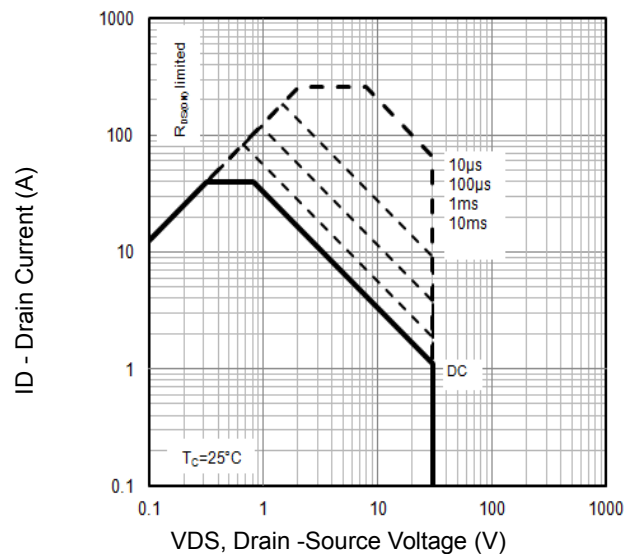

Fig6. Maximum Safe Operating Area

Typical Characteristics

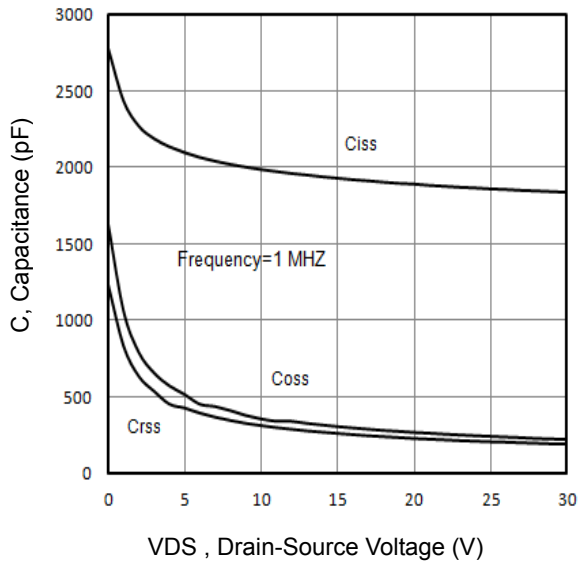

Fig7. Typical Capacitance Vs.Drain-Source Voltage

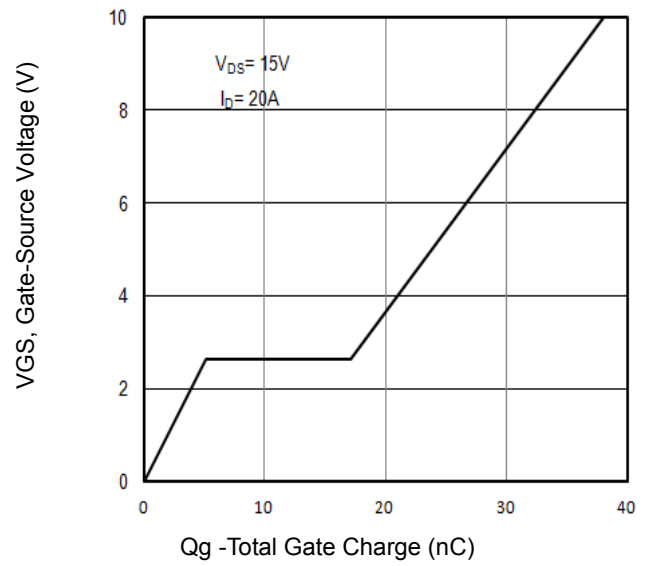

Fig8. Typical Gate Charge Vs.Gate-Source Voltage

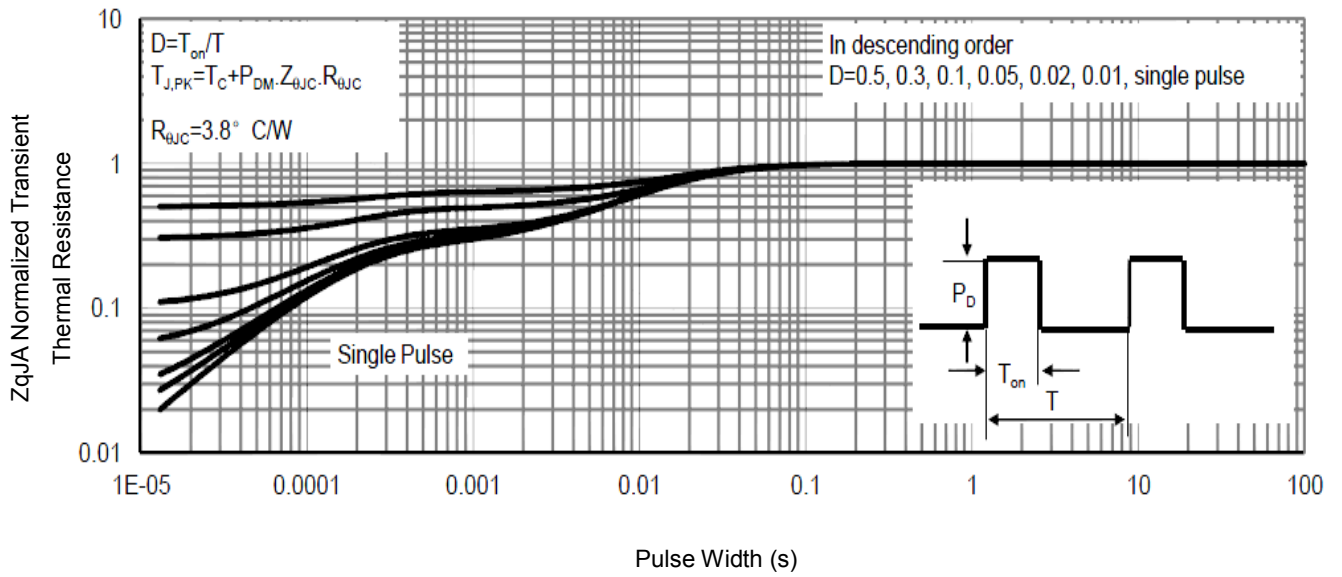

Fig9. Normalized Maximum Transient Thermal Impedance

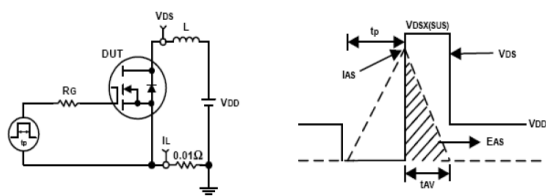

Fig10. Unclamped Inductive Test Circuit and waveforms

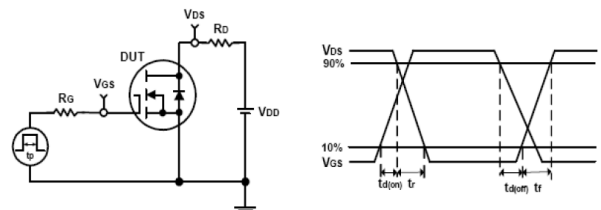
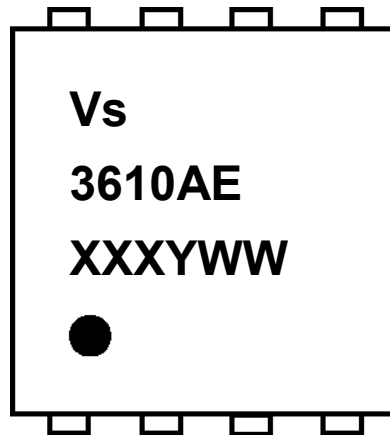

Fig11. Switching Time Test Circuit and waveforms



Marking Information



1st line: Vanguard Code (Vs)

2nd line: Part Number (3610AE)

3rd line: Date code (XXXYWW)

XXX: Wafer Lot Number Code , code changed with Lot Number

Y: Year Code (e.g. E=2017, F=2018, G=2019, H=2020, etc)

WW: Week Code (01 to 53)

PDFN3333 Package Outline Data

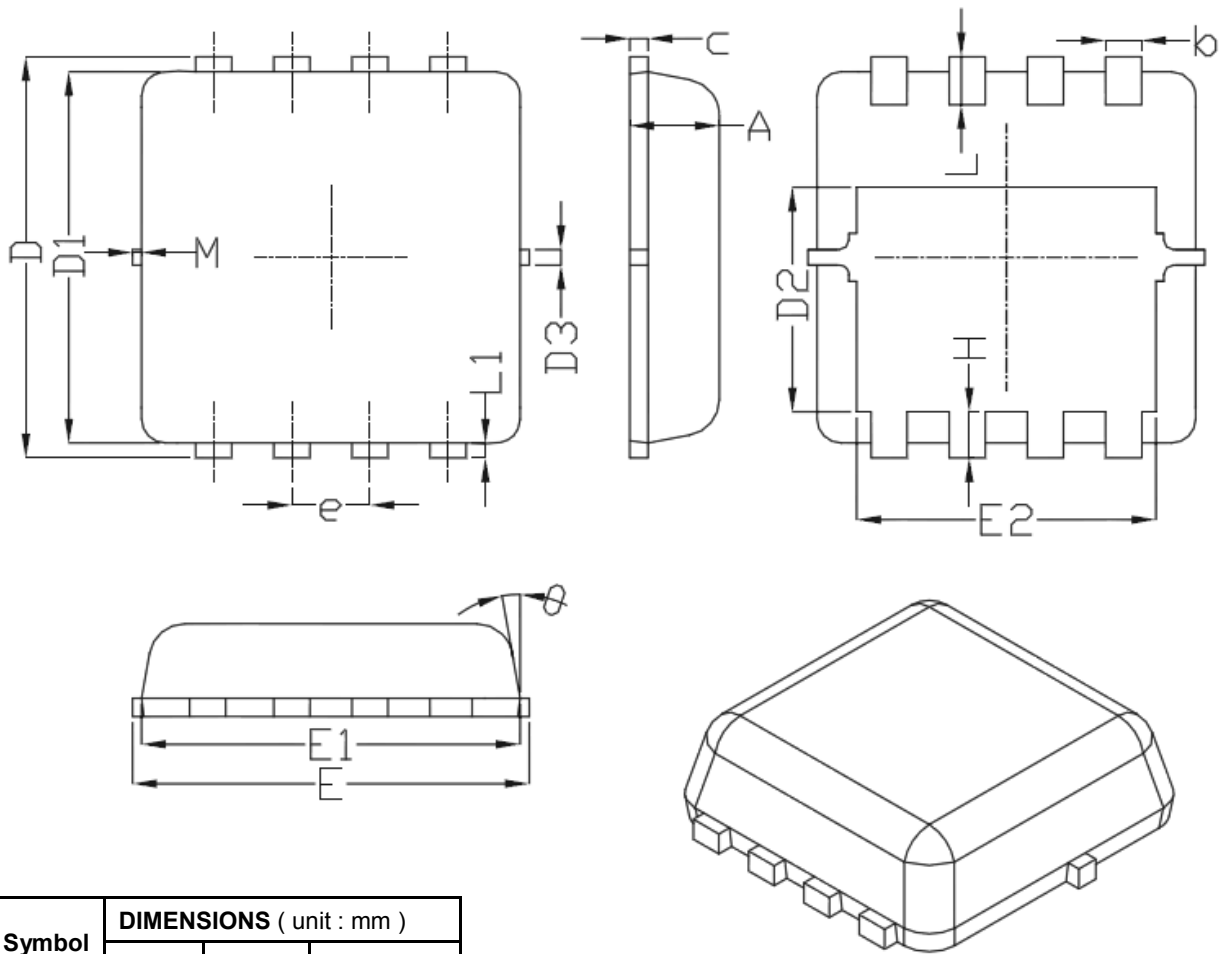

Symbol	DIMENSIONS (unit : mm)		
	Min	Typ	Max
A	0.7	0.75	0.8
b	0.25	0.3	0.35
C	0.1	0.15	0.25
D	3.25	3.35	3.45
D1	3	3.1	3.2
D2	1.78	1.88	1.98
D3	--	0.13	--
E	3.2	3.3	3.4
E1	3	3.15	3.2
E2	2.39	2.49	2.59
e	0.65 BSC		
H	0.3	0.39	0.5
L	0.3	0.4	0.5
L1	--	0.13	--
θ	--	10°	12°
M	*	*	0.15
* Not specified			

Notes:

1. Follow JEDEC MO-240 variation CA.
2. Dimensions "D1" and "E1" do NOT include mold flash protrusions or gate burrs.
3. Dimensions "D1" and "E1" include interterminal flash or protrusion. Interterminal flash or protrusion shall not exceed 0.25mm per side.

Customer Service

Sales and Service:

sales@vgsemi.com

Vanguard Semiconductor CO., LTD

TEL: (86-755) -26902410

FAX: (86-755) -26907027

WEB: www.vgsemi.com

X-ON Electronics

Largest Supplier of Electrical and Electronic Components

Click to view similar products for [MOSFET](#) category:

Click to view products by [Vanguard](#) manufacturer:

Other Similar products are found below :

[614233C](#) [648584F](#) [MCH3443-TL-E](#) [MCH6422-TL-E](#) [FDPF9N50NZ](#) [FW216A-TL-2W](#) [FW231A-TL-E](#) [APT5010JVR](#) [NTNS3A92PZT5G](#)
[IRF100S201](#) [JANTX2N5237](#) [2SK2464-TL-E](#) [2SK3818-DL-E](#) [FCA20N60_F109](#) [FDZ595PZ](#) [STD6600NT4G](#) [FSS804-TL-E](#) [2SJ277-DL-E](#)
[2SK1691-DL-E](#) [2SK2545\(Q,T\)](#) [D2294UK](#) [405094E](#) [423220D](#) [MCH6646-TL-E](#) [TPCC8103,L1Q\(CM](#) [367-8430-0972-503](#) [VN1206L](#)
[424134F](#) [026935X](#) [051075F](#) [SBVS138LT1G](#) [614234A](#) [715780A](#) [NTNS3166NZT5G](#) [751625C](#) [873612G](#) [IRF7380TRHR](#)
[IPS70R2K0CEAKMA1](#) [RJK60S3DPP-E0#T2](#) [RJK60S5DPK-M0#T0](#) [APT5010JVFR](#) [APT12031JFLL](#) [APT12040JVR](#) [DMN3404LQ-7](#)
[NTE6400](#) [JANTX2N6796U](#) [JANTX2N6784U](#) [JANTXV2N5416U4](#) [SQM110N05-06L-GE3](#) [SIHF35N60E-GE3](#)