

Features

- Enhancement mode
- Very low on-resistance
- VitoMOS[®] II Technology
- Fast Switching and High efficiency
- 100% Avalanche test

V_{DS}	30	V
$R_{DS(on),TYP@ V_{GS}=10V}$	4.9	m Ω
$R_{DS(on),TYP@ V_{GS}=4.5V}$	8	m Ω
$I_D(\text{Silicon Limited})$	60	A
$I_D(\text{Package Limited})$	40	A

PDFN3333

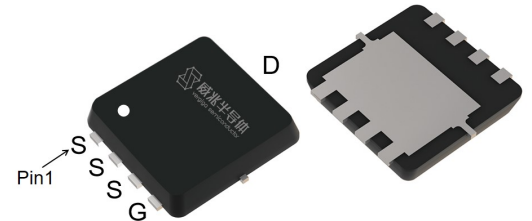

Part ID	Package Type	Marking	Packing
VS3620GEMC	PDFN3333	3620GE	5000PCS/Reel

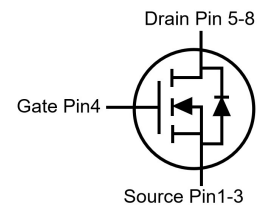

Maximum ratings, at $T_A = 25^\circ\text{C}$, unless otherwise specified

Symbol	Parameter	Rating	Unit	
$V_{(BR)DSS}$	Drain-Source breakdown voltage	30	V	
V_{GS}	Gate-Source voltage	± 20	V	
I_S	Diode continuous forward current	$T_C = 25^\circ\text{C}$	60	A
I_D	Continuous drain current @ $V_{GS}=10V$ (Silicon limited)	$T_C = 25^\circ\text{C}$	60	A
I_D	Continuous drain current @ $V_{GS}=10V$ (Silicon limited)	$T_C = 100^\circ\text{C}$	38	A
I_D	Continuous drain current @ $V_{GS}=10V$ (Package limited)	$T_C = 25^\circ\text{C}$	40	A
I_{DM}	Pulse drain current tested ①	$T_C = 25^\circ\text{C}$	240	A
I_{DSM}	Continuous drain current @ $V_{GS}=10V$	$T_A = 25^\circ\text{C}$	21	A
		$T_A = 70^\circ\text{C}$	17	A
E_{AS}	Avalanche energy, single pulsed ②	20	mJ	
PD	Maximum power dissipation	$T_C = 25^\circ\text{C}$	30	W
		$T_C = 100^\circ\text{C}$	12	W
P_{DSM}	Maximum power dissipation ③	$T_A = 25^\circ\text{C}$	3.6	W
		$T_A = 70^\circ\text{C}$	2.3	W
$T_{STG,TJ}$	Storage and Junction Temperature Range	-55 to 150	$^\circ\text{C}$	

Thermal Characteristics

Symbol	Parameter	Typical	Max	Unit
$R_{\theta JC}$	Thermal Resistance, Junction-to-Case	4.2	5	$^\circ\text{C/W}$
$R_{\theta JA}$	Thermal Resistance, Junction-to-Ambient	35	42	$^\circ\text{C/W}$

Electrical Characteristics

Symbol	Parameter	Condition	Min.	Typ.	Max.	Unit
Static Electrical Characteristics @ T_J=25°C (unless otherwise stated)						
V(BR)DSS	Drain-Source Breakdown Voltage	V _{GS} =0V, I _D =250μA	30	--	--	V
I _{DSS}	Zero Gate Voltage Drain Current(T _J =25°C)	V _{DS} =30V, V _{GS} =0V	--	--	1	μA
	Zero Gate Voltage Drain Current(T _J =125°C)	V _{DS} =30V, V _{GS} =0V	--	--	100	μA
I _{GSS}	Gate-Body Leakage Current	V _{GS} =±20V, V _{DS} =0V	--	--	±100	nA
V _{GS(th)}	Gate Threshold Voltage	V _{DS} =V _{GS} , I _D =250μA	1.3	1.8	2.4	V
R _{DS(on)}	Drain-Source On-State Resistance ④	V _{GS} =10V, I _D =20A	--	4.9	6.4	mΩ
		(T _J =100°C)	--	5.7	--	mΩ
R _{DS(on)}	Drain-Source On-State Resistance ④	V _{GS} =4.5V, I _D =10A	--	8	10.5	mΩ
Dynamic Electrical Characteristics @ T_J = 25°C (unless otherwise stated)						
C _{iss}	Input Capacitance	V _{DS} =15V, V _{GS} =0V, f=1MHz	565	750	1000	pF
C _{oss}	Output Capacitance		415	550	730	pF
C _{rss}	Reverse Transfer Capacitance		55	70	95	pF
R _g	Gate Resistance	f=1MHz	0.2	1.9	5	Ω
Q _{g(10V)}	Total Gate Charge	V _{DS} =15V, I _D =20A, V _{GS} =10V	--	15	20	nC
Q _{g(4.5V)}	Total Gate Charge		--	7.9	10.5	nC
Q _{gs}	Gate-Source Charge		--	2.9	3.9	nC
Q _{gd}	Gate-Drain Charge		--	3.6	5.4	nC
Switching Characteristics						
T _{d(on)}	Turn-on Delay Time	V _{DD} =15V, I _D =20A, R _G =3Ω, V _{GS} =10V	--	5.6	--	ns
T _r	Turn-on Rise Time		--	60	--	ns
T _{d(off)}	Turn-Off Delay Time		--	15	--	ns
T _f	Turn-Off Fall Time		--	9.6	--	ns
Source- Drain Diode Characteristics@ T_J = 25°C (unless otherwise stated)						
V _{SD}	Forward on voltage	I _{SD} =20A, V _{GS} =0V	--	0.9	1.2	V
T _{rr}	Reverse Recovery Time	I _{sd} =20A, V _{GS} =0V di/dt=100A/μs	--	10	20	ns
Q _{rr}	Reverse Recovery Charge		--	1	2	nC

NOTE: ① Single pulse; pulse width ≤ 100μs.

② Limited by T_{Jmax}, starting T_J = 25°C, L = 0.1mH, R_G = 25Ω, I_{AS} = 20A, V_{GS} = 10V. Part not recommended for use above this value

③ The power dissipation P_{DSM} is based on R_{θJA} and the maximum allowed junction temperature of 150°C.

④ Pulse width ≤ 380μs; duty cycle ≤ 2%.

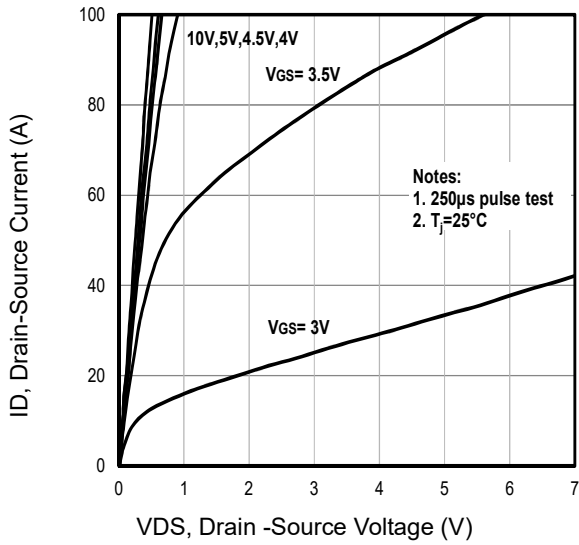
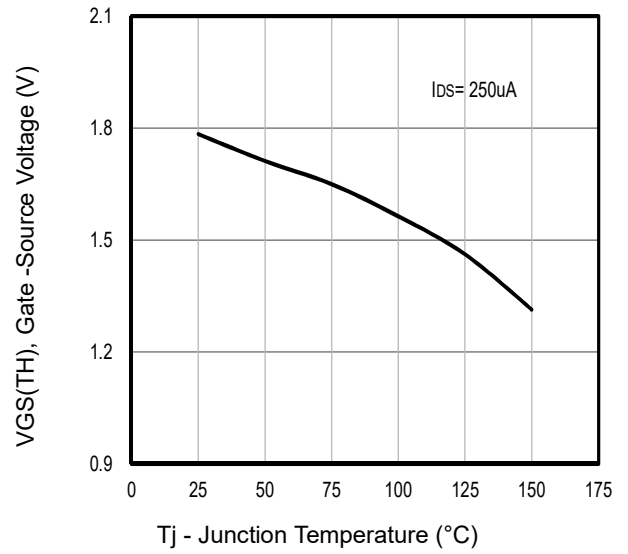
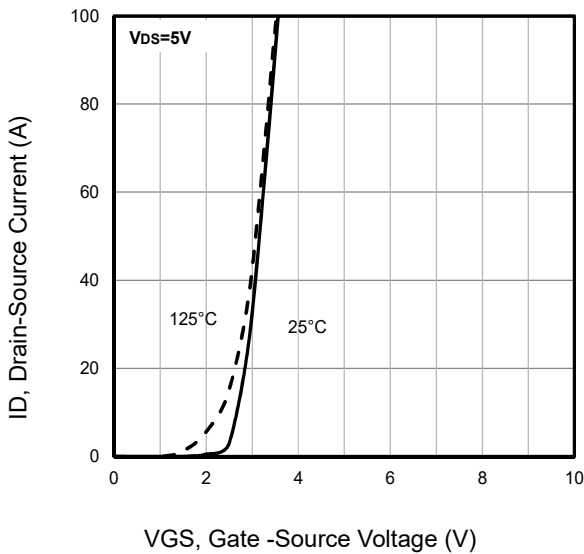
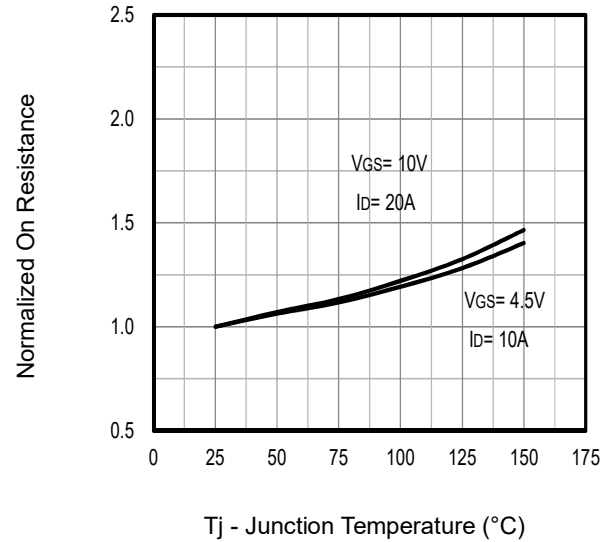
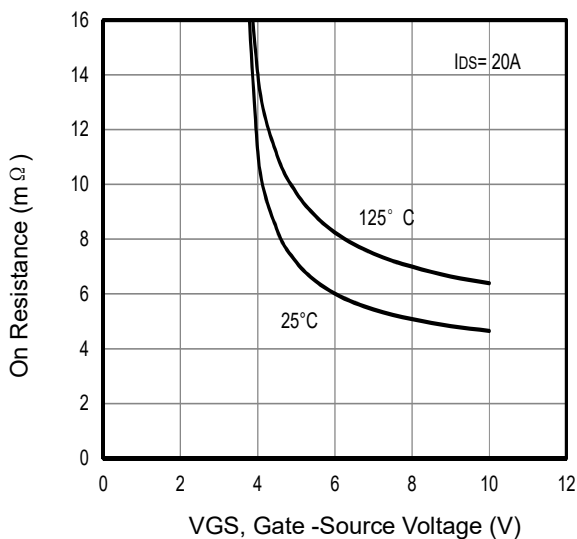
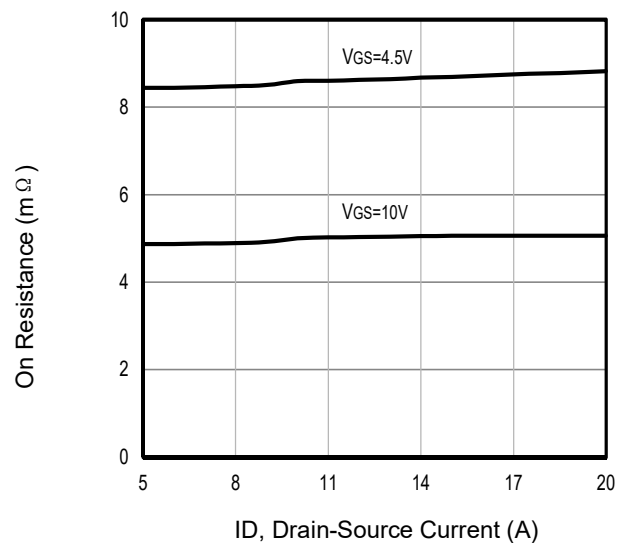
Typical Characteristics

Fig1. Typical Output Characteristics

Fig2. $V_{GS(TH)}$ Gate-Source Voltage Vs. T_j

Fig3. Typical Transfer Characteristics

Fig4. Normalized On-Resistance Vs. T_j

Fig5. On Resistance Vs Gate-Source Voltage

Fig6. On Resistance Vs Drain Current and Gate Voltage

Typical Characteristics

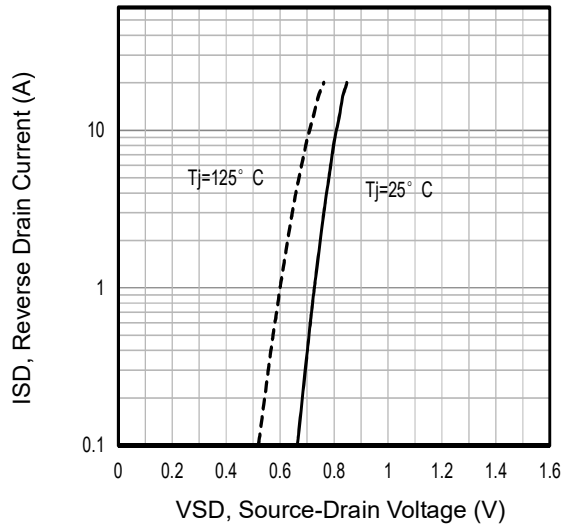

Fig7. Typical Source-Drain Diode Forward Voltage

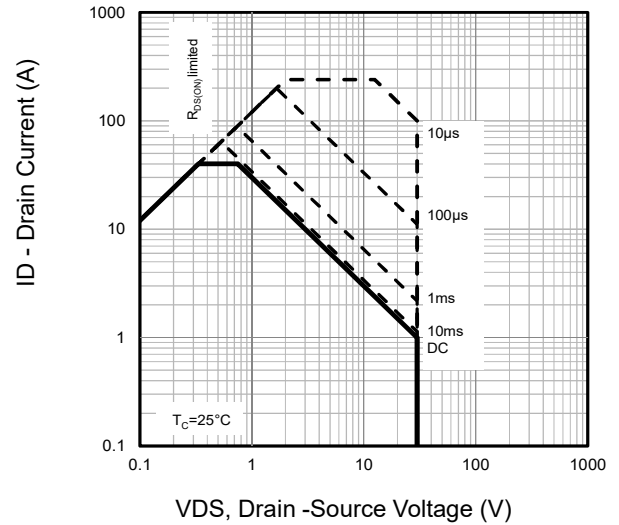

Fig8. Maximum Safe Operating Area

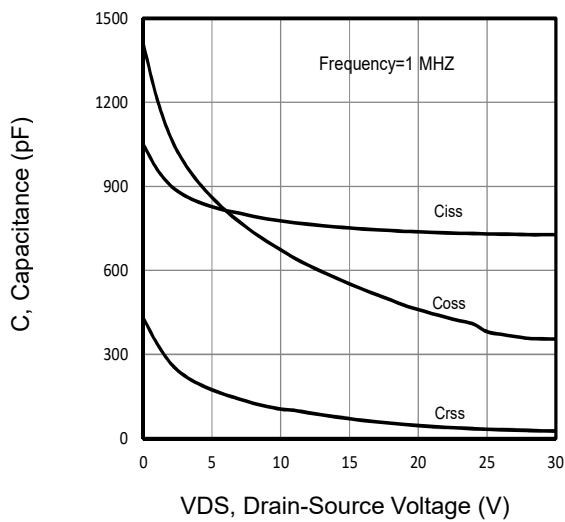

Fig9. Typical Capacitance Vs. Drain-Source Voltage

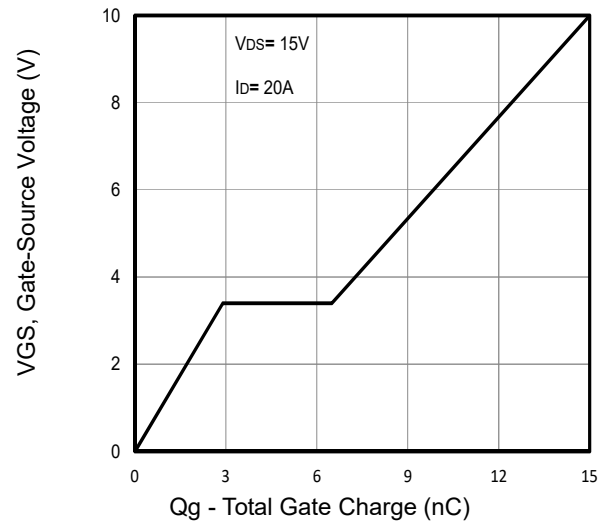

Fig10. Typical Gate Charge Vs. Gate-Source Voltage

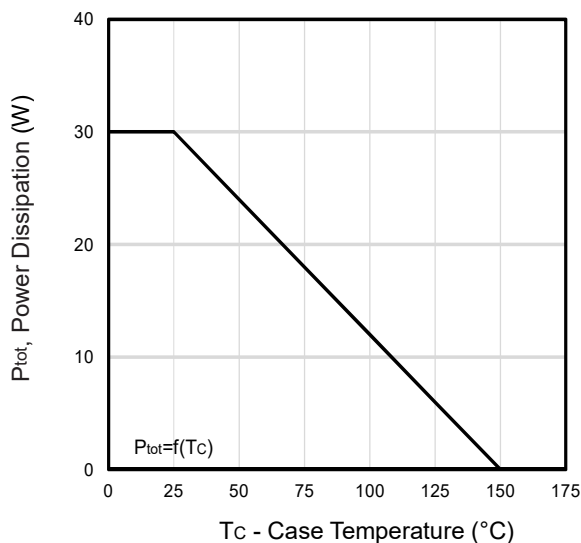

Fig11. Power Dissipation Vs. Case Temperature

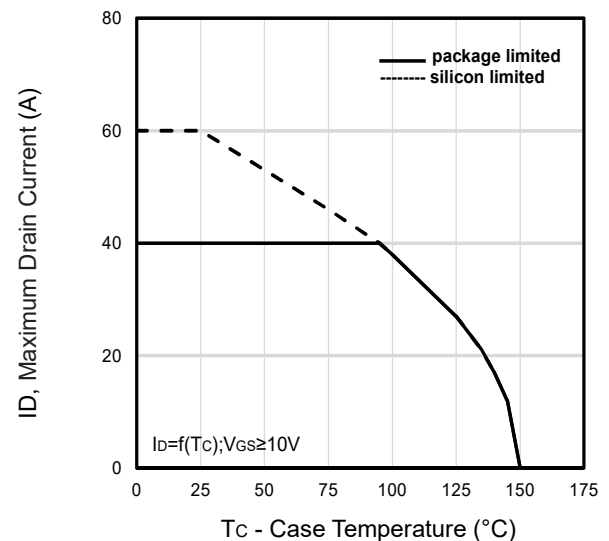

Fig12. Maximum Drain Current Vs. Case Temperature

Typical Characteristics

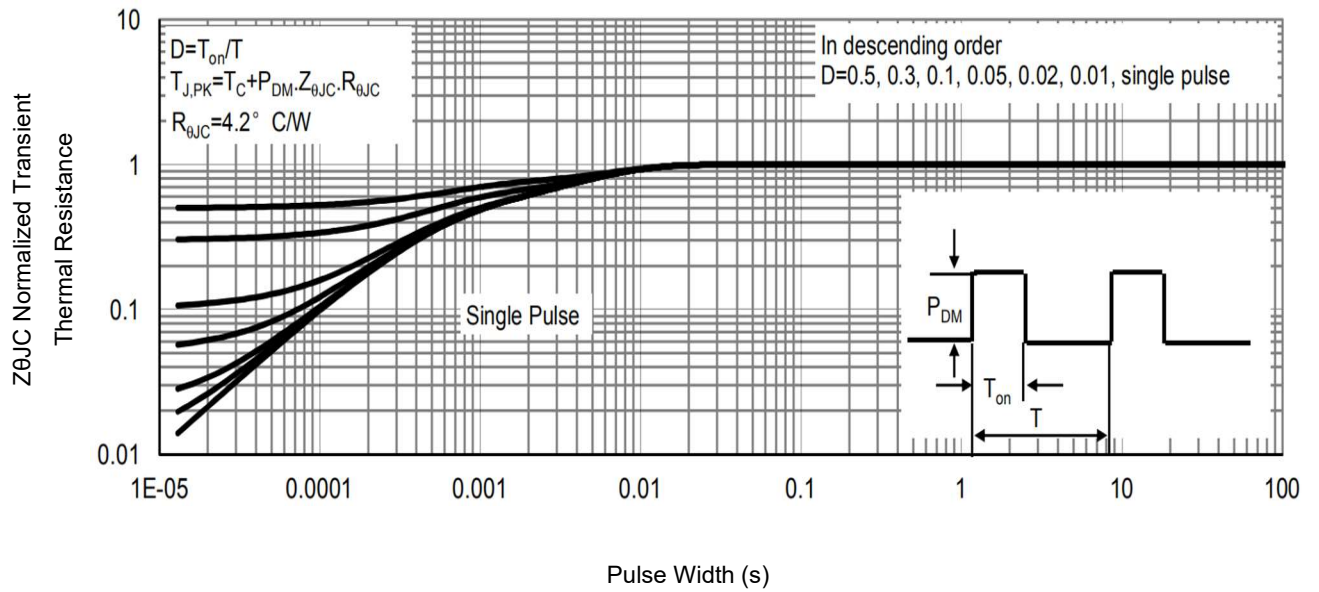

Fig13 . Normalized Maximum Transient Thermal Impedance

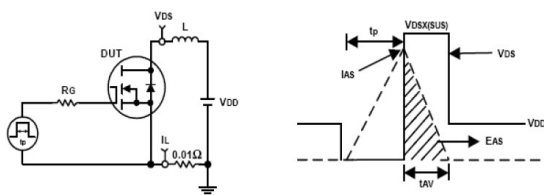

Fig14. Unclamped Inductive Test Circuit and waveforms

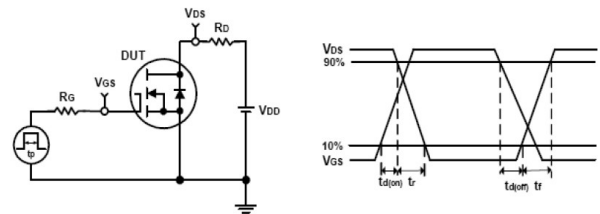
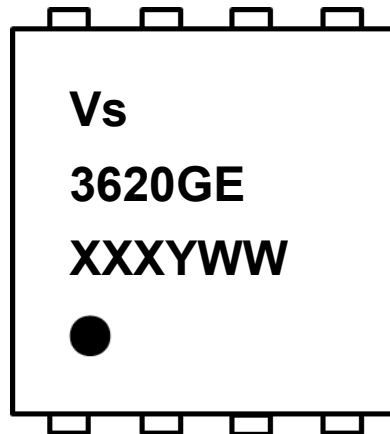

Fig15. Switching Time Test Circuit and waveforms

Marking Information

1st line: Vergiga Code (Vs)

2nd line: Part Number (3620GE)

3rd line: Date code (XXXYWW)

XXX: Wafer Lot Number Code , code changed with Lot Number

Y: Year Code , refer to table below

WW: Week Code (01 to 53)

Code	C	D	E	F	G	H	J	K	L	M	N	P	Q	R	S	T
Year	2015	2016	2017	2018	2019	2020	2021	2022	2023	2024	2025	2026	2027	2028	2029	2030

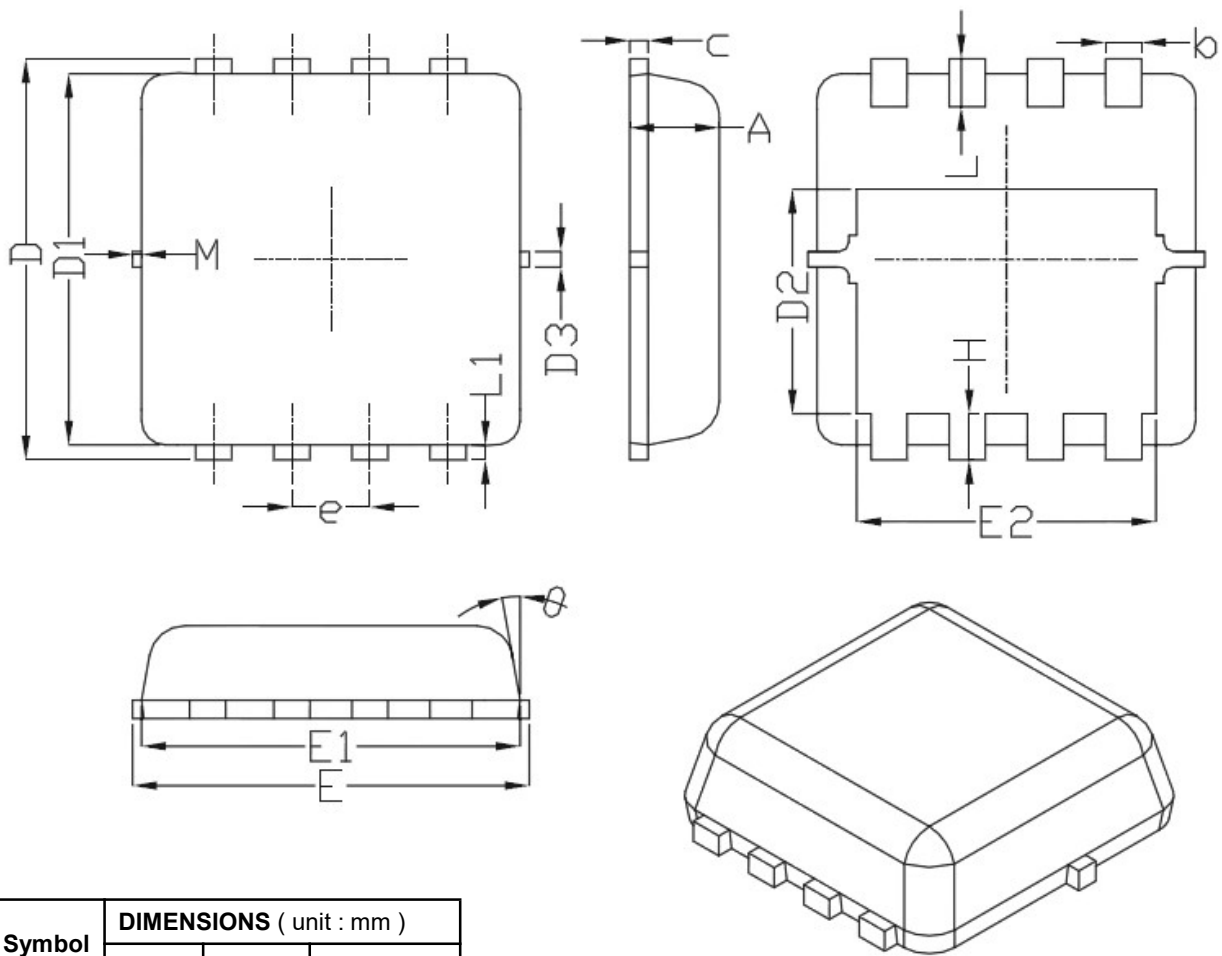
PDFN3333 Package Outline Data

Symbol	DIMENSIONS (unit : mm)		
	Min	Typ	Max
A	0.7	0.75	0.8
b	0.25	0.3	0.35
C	0.1	0.15	0.25
D	3.25	3.35	3.45
D1	3	3.1	3.2
D2	1.78	1.88	1.98
D3	--	0.13	--
E	3.2	3.3	3.4
E1	3	3.15	3.2
E2	2.39	2.49	2.59
e	0.65 BSC		
H	0.3	0.39	0.5
L	0.3	0.4	0.5
L1	--	0.13	--
θ	--	10°	12°
M	*	*	0.15
* Not specified			

Notes:

1. Follow JEDEC MO-240 variation CA.
2. Dimensions "D1" and "E1" do NOT include mold flash protrusions or gate burrs.
3. Dimensions "D1" and "E1" include interterminal flash or protrusion. Interterminal flash or protrusion shall not exceed 0.25mm per side.

Customer Service
Sales and Service:
sales@vgsemi.com
Vergiga Semiconductor CO., LTD
TEL: (86-755) -26902410

FAX: (86-755) -26907027

WEB: www.vgsemi.com

X-ON Electronics

Largest Supplier of Electrical and Electronic Components

Click to view similar products for [MOSFET](#) category:

Click to view products by [Vanguard](#) manufacturer:

Other Similar products are found below :

[614233C](#) [648584F](#) [IRFD120](#) [IRFF430](#) [JANTX2N5237](#) [2N7000](#) [FCA20N60_F109](#) [FDZ595PZ](#) [AOD464](#) [2SK2267\(Q\)](#) [2SK2545\(Q,T\)](#)
[405094E](#) [423220D](#) [MIC4420CM-TR](#) [VN1206L](#) [614234A](#) [715780A](#) [SSM6J414TU,LF\(T](#) [751625C](#) [PSMN4R2-30MLD](#)
[TK31J60W5,S1VQ\(O](#) [2SK2614\(TE16L1,Q\)](#) [DMN1017UCP3-7](#) [EFC2J004NUZTDG](#) [FCAB21350L1](#) [P85W28HP2F-7071](#) [DMN1053UCP4-7](#)
[NTE2384](#) [NTE2969](#) [NTE6400A](#) [DMN2080UCB4-7](#) [DMN61D9UWQ-13](#) [US6M2GTR](#) [DMN31D5UDJ-7](#) [SSM6P54TU,LF](#) [DMP22D4UFO-](#)
[7B](#) [IPS60R3K4CEAKMA1](#) [DMN1006UCA6-7](#) [DMN16M9UCA6-7](#) [STF5N65M6](#) [STU5N65M6](#) [C3M0021120D](#) [DMN13M9UCA6-7](#)
[BSS340NWH6327XTSA1](#) [MCM3400A-TP](#) [DMTH10H4M6SPS-13](#) [IRF40SC240ARMA1](#) [IPS60R1K0PFD7SAKMA1](#)
[IPS60R360PFD7SAKMA1](#) [IPS60R600PFD7SAKMA1](#)