

## Features

- N-Channel, 5V Logic Level Control
- Enhancement mode
- Low on-resistance  $R_{DS(on)}$  @  $V_{GS}=4.5\text{ V}$
- Fast Switching
- 100% Avalanche test
- Pb-free lead plating; RoHS compliant



| Part ID  | Package Type | Marking | Tape and reel information |
|----------|--------------|---------|---------------------------|
| VS3622AE | PDFN3333     | 3622AE  | 5000PCS/Reel              |

|  |     |            |
|--|-----|------------|
| $V_{DS}$                               | 30  | V          |
| $R_{DS(on),TYP} @ V_{GS}=10\text{ V}$  | 7.9 | m $\Omega$ |
| $R_{DS(on),TYP} @ V_{GS}=4.5\text{ V}$ | 12  | m $\Omega$ |
| $I_D$                                  | 45  | A          |

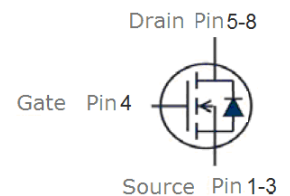
**PDFN3333**

## Maximum ratings, at $T_A = 25^\circ\text{C}$ , unless otherwise specified

| Symbol         | Parameter                                      | Rating                    | Unit             |
|----------------|--|---------------------------|------------------|
| $V_{(BR)DSS}$  | Drain-Source breakdown voltage                 | 30                        | V                |
| $I_S$          | Diode continuous forward current               | $T_C = 25^\circ\text{C}$  | 45 A             |
| $I_D$          | Continuous drain current @ $V_{GS}=10\text{V}$ | $T_C = 25^\circ\text{C}$  | 45 A             |
|                |  | $T_C = 100^\circ\text{C}$ | 28 A             |
| $I_{DM}$       | Pulse drain current tested ①                   | $T_C = 25^\circ\text{C}$  | 180 A            |
| EAS            | Avalanche energy, single pulsed ②              | 20                        | mJ               |
| $P_D$          | Maximum power dissipation                      | $T_C = 25^\circ\text{C}$  | 28 W             |
| $V_{GS}$       | Gate-Source voltage                            | $\pm 20$                  | V                |
| $T_{STG}, T_J$ | Storage and Junction Temperature Range         | -55 to 150                | $^\circ\text{C}$ |

## Thermal Characteristics

| Symbol          | Parameter                               | Typical | Unit               |
|-----------------|---|---------|--------------------|
| $R_{\theta JC}$ | Thermal Resistance, Junction-to-Case    | 4.5     | $^\circ\text{C/W}$ |
| $R_{\theta JA}$ | Thermal Resistance, Junction-to-Ambient | 35      | $^\circ\text{C/W}$ |

**Electrical Characteristics**

| Symbol  | Parameter  | Condition  | Min. | Typ. | Max. | Unit |
|---|--|--|------|------|------|------|
| <b>Static Electrical Characteristics @ T<sub>j</sub>=25°C (unless otherwise stated)</b>     |  |  |      |      |      |      |
| V <sub>(BR)DSS</sub>  | Drain-Source Breakdown Voltage                         | V <sub>GS</sub> =0V, I <sub>D</sub> =250μA   | 30   | --   | --   | V    |
| I <sub>DSS</sub>  | Zero Gate Voltage Drain Current                        | V <sub>DS</sub> =30V, V <sub>GS</sub> =0V  | --   | --   | 1    | μA   |
|   | Zero Gate Voltage Drain Current(T <sub>j</sub> =125°C) | V <sub>DS</sub> =30V, V <sub>GS</sub> =0V  | --   | --   | 100  | μA   |
| I <sub>GSS</sub>  | Gate-Body Leakage Current                              | V <sub>GS</sub> =±20V, V <sub>DS</sub> =0V   | --   | --   | ±100 | nA   |
| V <sub>GS(TH)</sub>   | Gate Threshold Voltage                                 | V <sub>DS</sub> =V <sub>GS</sub> , I <sub>D</sub> =250μA                                       | 1.3  | 1.9  | 2.5  | V    |
| R <sub>DS(ON)</sub>   | Drain-Source On-State Resistance <sup>③</sup>          | V <sub>GS</sub> =10V, I <sub>D</sub> =20A  | --   | 7.9  | 10   | mΩ   |
| R <sub>DS(ON)</sub>   | Drain-Source On-State Resistance <sup>③</sup>          | V <sub>GS</sub> =4.5V, I <sub>D</sub> =10A   | --   | 12   | 15   | mΩ   |
| <b>Dynamic Electrical Characteristics @ T<sub>j</sub> = 25°C (unless otherwise stated)</b>  |  |  |      |      |      |      |
| C <sub>iss</sub>  | Input Capacitance                                      | V <sub>DS</sub> =15V, V <sub>GS</sub> =0V,<br>f=1MHz   | --   | 860  | --   | pF   |
| C <sub>oss</sub>  | Output Capacitance                                     |  | --   | 140  | --   | pF   |
| C <sub>rss</sub>  | Reverse Transfer Capacitance                           |  | --   | 105  | --   | pF   |
| R <sub>g</sub>  | Gate Resistance  | f=1MHz   | --   | 2.7  | --   | Ω    |
| Q <sub>g</sub> (10V)  | Total Gate Charge                                      | V <sub>DS</sub> =15V, I <sub>D</sub> =20A,<br>V <sub>GS</sub> =10V                             | --   | 19   | --   | nC   |
| Q <sub>g</sub> (4.5V)   | Total Gate Charge                                      |  | --   | 13   | --   | nC   |
| Q <sub>gs</sub>   | Gate-Source Charge                                     |  | --   | 4.3  | --   | nC   |
| Q <sub>gd</sub>   | Gate-Drain Charge                                      |  | --   | 6.5  | --   | nC   |
| <b>Switching Characteristics</b>  |  |  |      |      |      |      |
| t <sub>d(on)</sub>  | Turn-on Delay Time                                     | V <sub>DD</sub> =15V,<br>I <sub>D</sub> =20A,<br>R <sub>G</sub> =3.0Ω,<br>V <sub>GS</sub> =10V | --   | 6    | --   | ns   |
| t <sub>r</sub>  | Turn-on Rise Time                                      |  | --   | 5    | --   | ns   |
| t <sub>d(off)</sub>   | Turn-Off Delay Time                                    |  | --   | 25   | --   | ns   |
| t <sub>f</sub>  | Turn-Off Fall Time                                     |  | --   | 7    | --   | ns   |
| <b>Source- Drain Diode Characteristics @ T<sub>j</sub> = 25°C (unless otherwise stated)</b> |  |  |      |      |      |      |
| V <sub>SD</sub>   | Forward on voltage                                     | I <sub>SD</sub> =20A, V <sub>GS</sub> =0V  | --   | 0.9  | 1.2  | V    |
| t <sub>rr</sub>   | Reverse Recovery Time                                  | T <sub>j</sub> =25°C, I <sub>sd</sub> =20A,<br>V <sub>GS</sub> =0V<br>di/dt=500A/μs            | --   | 7    | --   | ns   |
| Q <sub>rr</sub>   | Reverse Recovery Charge                                |  | --   | 6.3  | --   | nC   |

**NOTE:**

- ① Repetitive rating; pulse width limited by max junction temperature.
- ② Limited by T<sub>Jmax</sub>, starting T<sub>J</sub> = 25°C, L = 0.5mH, R<sub>G</sub> = 25Ω, I<sub>AS</sub> = 9A, V<sub>GS</sub> = 10V. Part not recommended for use above this value
- ③ Pulse width ≤ 300μs; duty cycles ≤ 2%.

**Typical Characteristics**

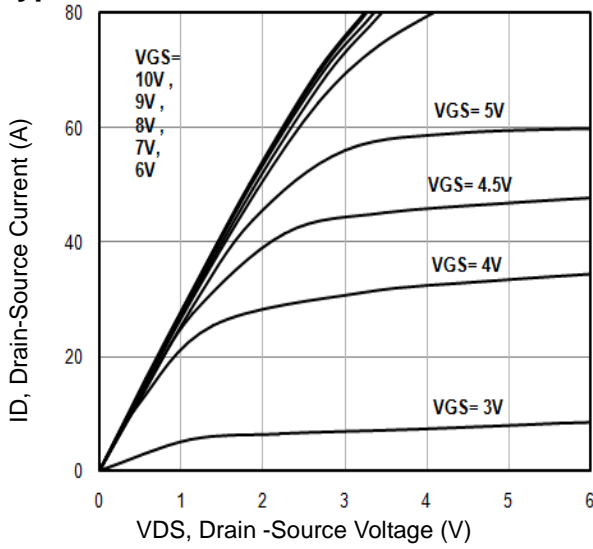

**Fig1.** Typical Output Characteristics

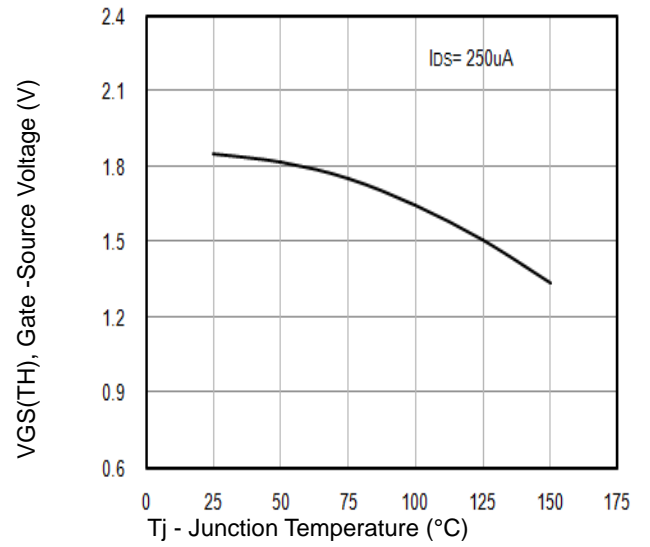

**Fig2.**  $V_{GS(TH)}$  Gate -Source Voltage Vs.  $T_j$

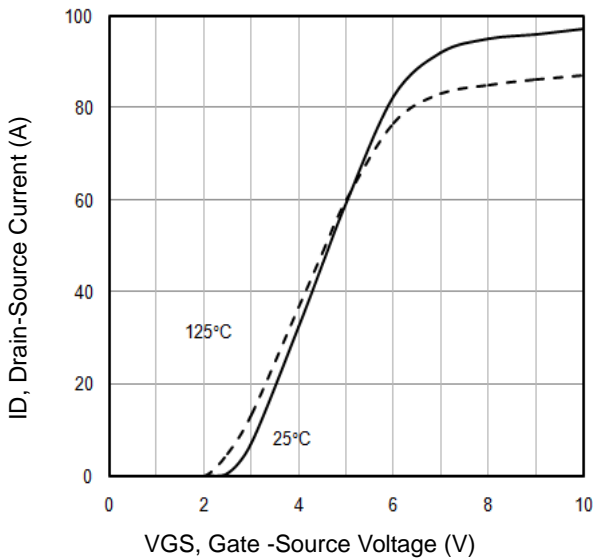

**Fig3.** Typical Transfer Characteristics

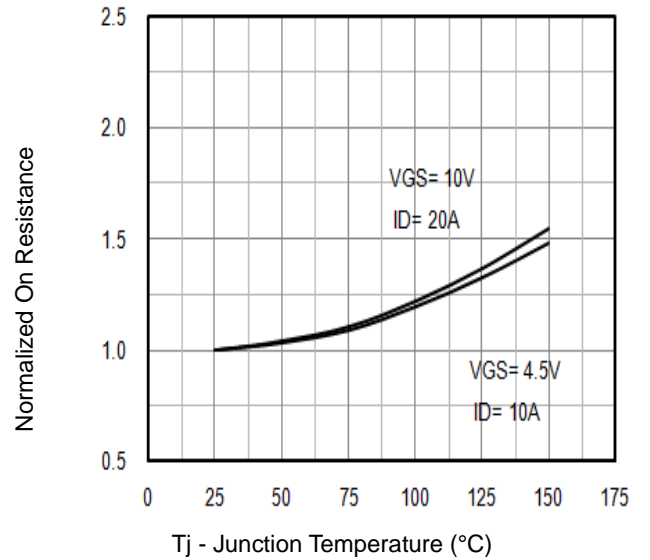

**Fig4.** Normalized On-Resistance Vs.  $T_j$

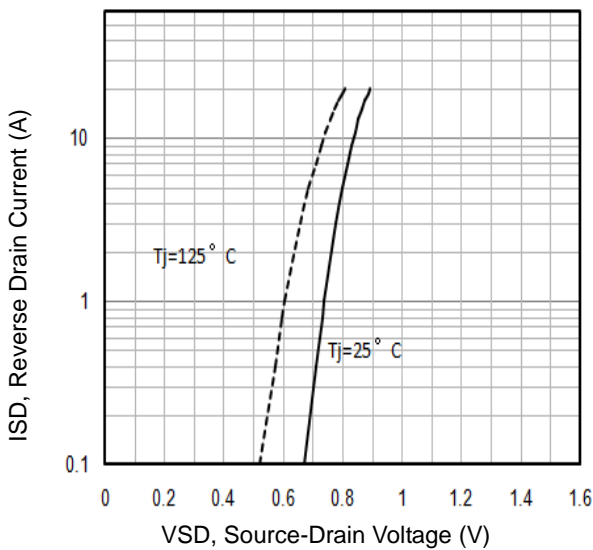

**Fig5.** Typical Source-Drain Diode Forward Voltage

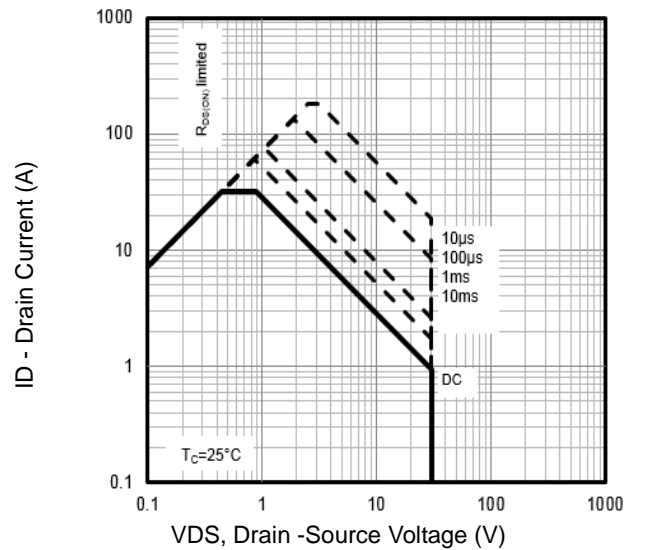

**Fig6.** Maximum Safe Operating Area

Typical Characteristics

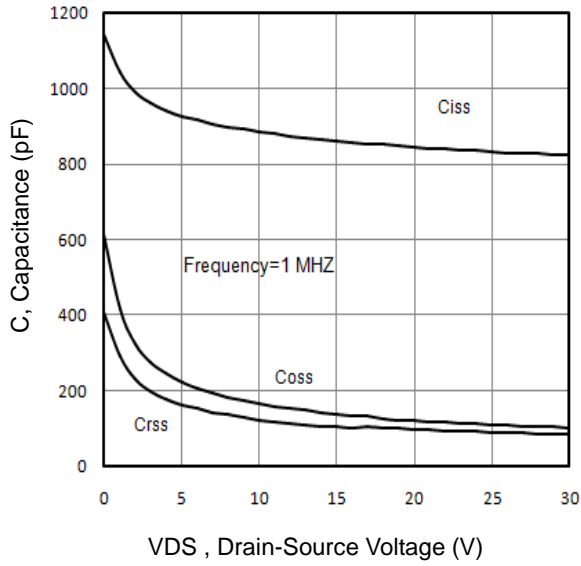

Fig7. Typical Capacitance Vs.Drain-Source Voltage

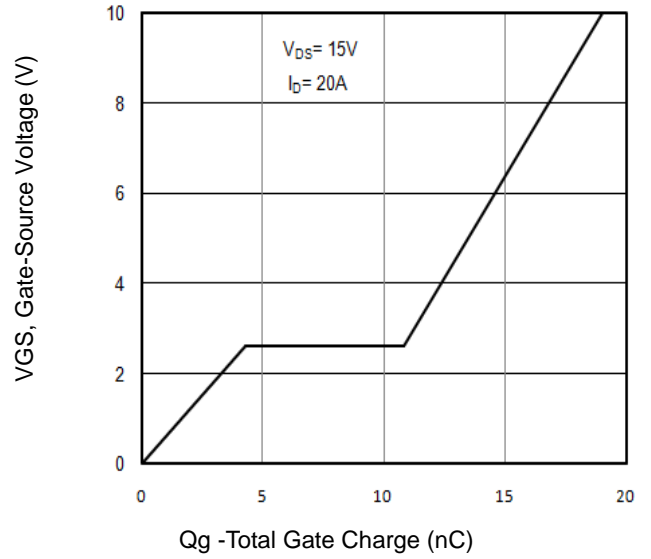

Fig8. Typical Gate Charge Vs.Gate-Source Voltage

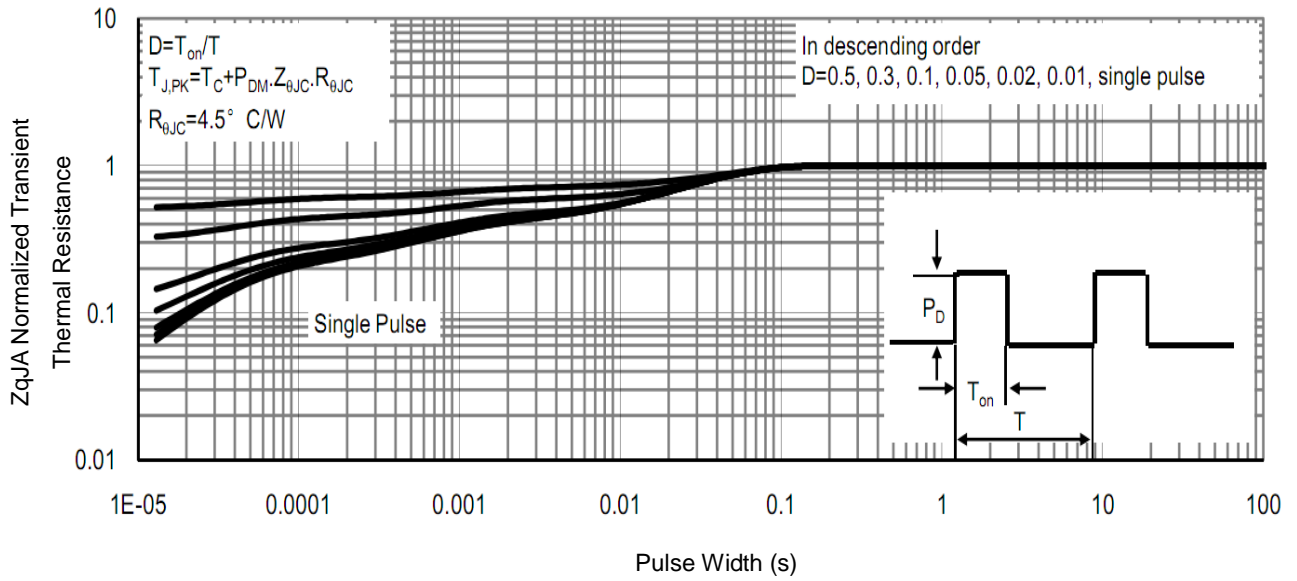

Fig9. Normalized Maximum Transient Thermal Impedance

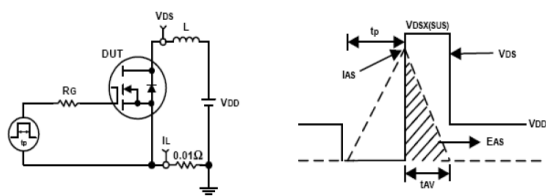

Fig10. Unclamped Inductive Test Circuit and waveforms

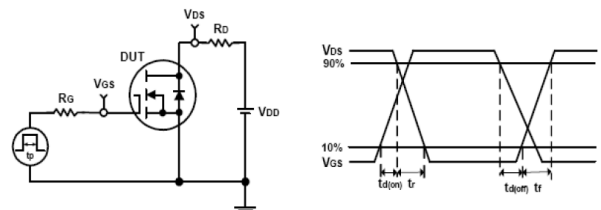
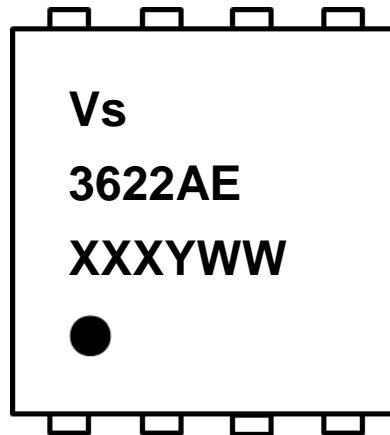

Fig11. Switching Time Test Circuit and waveforms



**Marking Information (Laser)**



1<sup>st</sup> line: Vanguard Code (Vs)

2<sup>nd</sup> line: Part Number (3622AE)

3<sup>rd</sup> line: Date code (XXXYWW)

XXX: Wafer Lot Number

Y: Year Code, e.g. E means 2017

WW: Week Code

Dot: pin 1 identification

PDFN3333 Package Outline Data

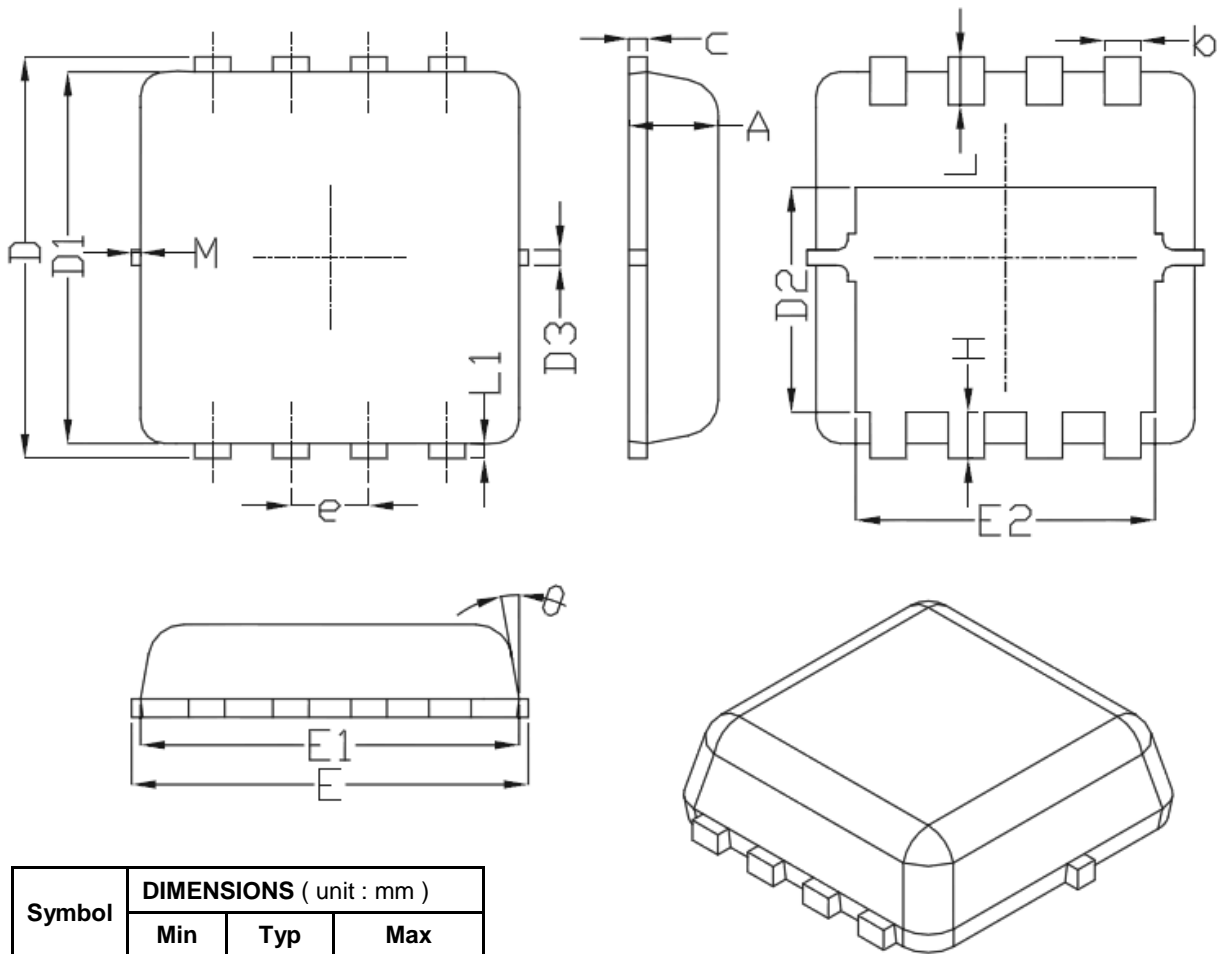

| Symbol          | DIMENSIONS ( unit : mm ) |      |      |
|-----------------|--------------------------|------|------|
|                 | Min                      | Typ  | Max  |
| A               | 0.7                      | 0.75 | 0.8  |
| b               | 0.25                     | 0.3  | 0.35 |
| C               | 0.1                      | 0.15 | 0.25 |
| D               | 3.25                     | 3.35 | 3.45 |
| D1              | 3                        | 3.1  | 3.2  |
| D2              | 1.78                     | 1.88 | 1.98 |
| D3              | --                       | 0.13 | --   |
| E               | 3.2                      | 3.3  | 3.4  |
| E1              | 3                        | 3.15 | 3.2  |
| E2              | 2.39                     | 2.49 | 2.59 |
| e               | 0.65 BSC                 |      |      |
| H               | 0.3                      | 0.39 | 0.5  |
| L               | 0.3                      | 0.4  | 0.5  |
| L1              | --                       | 0.13 | --   |
| θ               | --                       | 10°  | 12°  |
| M               | *                        | *    | 0.15 |
| * Not specified |                          |      |      |

Notes:

1. Follow JEDEC MO-240 variation CA.
2. Dimensions "D1" and "E1" do NOT include mold flash protrusions or gate burrs.
3. Dimensions "D1" and "E1" include interterminal flash or protrusion. Interterminal flash or protrusion shall not exceed 0.25mm per side.

Customer Service

Sales and Service:

[sales@vgsemi.com](mailto:sales@vgsemi.com)

Vanguard Semiconductor CO., LTD

TEL: (86-755) -26902410

FAX: (86-755) -26907027

## X-ON Electronics

Largest Supplier of Electrical and Electronic Components

*Click to view similar products for [MOSFET](#) category:*

*Click to view products by [Vanguard](#) manufacturer:*

Other Similar products are found below :

[614233C](#) [648584F](#) [MCH3443-TL-E](#) [MCH6422-TL-E](#) [FDPF9N50NZ](#) [FW216A-TL-2W](#) [FW231A-TL-E](#) [APT5010JVR](#) [NTNS3A92PZT5G](#)  
[IRF100S201](#) [JANTX2N5237](#) [2SK2464-TL-E](#) [2SK3818-DL-E](#) [FCA20N60\\_F109](#) [FDZ595PZ](#) [STD6600NT4G](#) [FSS804-TL-E](#) [2SJ277-DL-E](#)  
[2SK1691-DL-E](#) [2SK2545\(Q,T\)](#) [D2294UK](#) [405094E](#) [423220D](#) [MCH6646-TL-E](#) [TPCC8103,L1Q\(CM](#) [367-8430-0972-503](#) [VN1206L](#)  
[424134F](#) [026935X](#) [051075F](#) [SBVS138LT1G](#) [614234A](#) [715780A](#) [NTNS3166NZT5G](#) [751625C](#) [873612G](#) [IRF7380TRHR](#)  
[IPS70R2K0CEAKMA1](#) [RJK60S3DPP-E0#T2](#) [RJK60S5DPK-M0#T0](#) [APT5010JVFR](#) [APT12031JFLL](#) [APT12040JVR](#) [DMN3404LQ-7](#)  
[NTE6400](#) [JANTX2N6796U](#) [JANTX2N6784U](#) [JANTXV2N5416U4](#) [SQM110N05-06L-GE3](#) [SIHF35N60E-GE3](#)