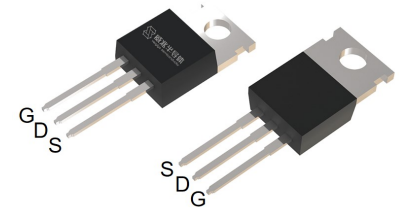

Features

- Enhancement mode
- Very low on-resistance
- Fast Switching and High efficiency
- 100% Avalanche test

V_{DS}	40	V
$R_{DS(on),TYP@ V_{GS}=10V}$	1.4	mΩ
$I_D(\text{Silicon Limited})$	400	A
$I_D(\text{Package Limited})$	130	A

TO-220AB

Part ID	Package Type	Marking	Packing
VS4401ATH	TO-220AB	4401ATH	50pcs/Tube

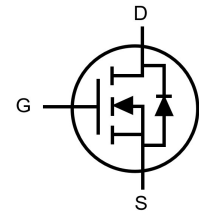

Maximum ratings, at $T_A = 25^\circ\text{C}$, unless otherwise specified

Symbol	Parameter	Rating	Unit
$V_{(BR)DSS}$	Drain-Source breakdown voltage	40	V
V_{GS}	Gate-Source voltage	± 25	V
I_S	Diode continuous forward current	$T_C = 25^\circ\text{C}$	400 A
I_D	Continuous drain current @ $V_{GS}=10V$ (Silicon limited)	$T_C = 25^\circ\text{C}$	400 A
I_D	Continuous drain current @ $V_{GS}=10V$ (Silicon limited)	$T_C = 100^\circ\text{C}$	283 A
I_D	Continuous drain current @ $V_{GS}=10V$ (Wire bond limited)	$T_C = 25^\circ\text{C}$	130 A
I_{DM}	Pulse drain current tested ①	$T_C = 25^\circ\text{C}$	1000 A
I_{DSM}	Continuous drain current @ $V_{GS}=10V$	$T_A = 25^\circ\text{C}$	29 A
		$T_A = 70^\circ\text{C}$	23 A
E_{AS}	Avalanche energy, single pulsed ②	900	mJ
P_D	Maximum power dissipation	$T_C = 25^\circ\text{C}$	375 W
		$T_C = 100^\circ\text{C}$	188 W
P_{DSM}	Maximum power dissipation ③	$T_A = 25^\circ\text{C}$	2 W
		$T_A = 70^\circ\text{C}$	1.3 W
$T_{STG,TJ}$	Storage and Junction Temperature Range	-55 to 175	$^\circ\text{C}$

Thermal Characteristics

Symbol	Parameter	Typical	Max	Unit
$R_{\theta JC}$	Thermal Resistance, Junction-to-Case	0.4	0.5	$^\circ\text{C/W}$
$R_{\theta JA}$	Thermal Resistance, Junction-to-Ambient	62.5	75	$^\circ\text{C/W}$

Electrical Characteristics

Symbol	Parameter	Condition	Min.	Typ.	Max.	Unit
Static Electrical Characteristics @ T_J=25°C (unless otherwise stated)						
V(BR)DSS	Drain-Source Breakdown Voltage	V _{GS} =0V, I _D =250μA	40	--	--	V
I _{DSS}	Zero Gate Voltage Drain Current(T _J =25°C)	V _{DS} =40V, V _{GS} =0V	--	--	1	μA
	Zero Gate Voltage Drain Current(T _J =125°C)	V _{DS} =40V, V _{GS} =0V	--	--	100	μA
I _{GSS}	Gate-Body Leakage Current	V _{GS} =±25V, V _{DS} =0V	--	--	±100	nA
V _{GS(th)}	Gate Threshold Voltage	V _{DS} =V _{GS} , I _D =250μA	2.6	3.1	3.6	V
R _{DS(on)}	Drain-Source On-State Resistance ④	V _{GS} =10V, I _D =80A	--	1.4	1.8	mΩ
		(T _J =100°C)	--	1.7	--	mΩ
Dynamic Electrical Characteristics @ T_J = 25°C (unless otherwise stated)						
C _{iss}	Input Capacitance	V _{DS} =20V, V _{GS} =0V, f=1MHz	9635	12845	17085	pF
C _{oss}	Output Capacitance		1275	1700	2260	pF
C _{rss}	Reverse Transfer Capacitance		1070	1425	1895	pF
R _g	Gate Resistance	f=1MHz	0.2	1.3	5	Ω
Q _g	Total Gate Charge	V _{DS} =20V, I _D =80A, V _{GS} =10V	--	237	315	nC
Q _{gs}	Gate-Source Charge		--	67	89	nC
Q _{gd}	Gate-Drain Charge		--	70	105	nC
Switching Characteristics						
T _{d(on)}	Turn-on Delay Time	V _{DD} =20V, I _D =80A, R _G =3Ω, V _{GS} =10V	--	45	--	ns
T _r	Turn-on Rise Time		--	200	--	ns
T _{d(off)}	Turn-Off Delay Time		--	116	--	ns
T _f	Turn-Off Fall Time		--	112	--	ns
Source- Drain Diode Characteristics@ T_J = 25°C (unless otherwise stated)						
V _{SD}	Forward on voltage	I _{SD} =80A, V _{GS} =0V	--	0.8	1.2	V
T _{rr}	Reverse Recovery Time	I _{sd} =80A, V _{GS} =0V	--	39	78	ns
Q _{rr}	Reverse Recovery Charge	di/dt=100A/μs	--	32	64	nC

NOTE: ① Single pulse; pulse width ≤ 100μs.

② Limited by T_{Jmax}, starting T_J = 25°C, L = 0.5mH, R_G = 25Ω, I_{AS} = 60A, V_{GS} = 10V. Part not recommended for use above this value

③ The power dissipation P_{DSM} is based on R_{θJA} and the maximum allowed junction temperature of 150°C.

④ Pulse width ≤ 380μs; duty cycles ≤ 2%.

Typical Characteristics

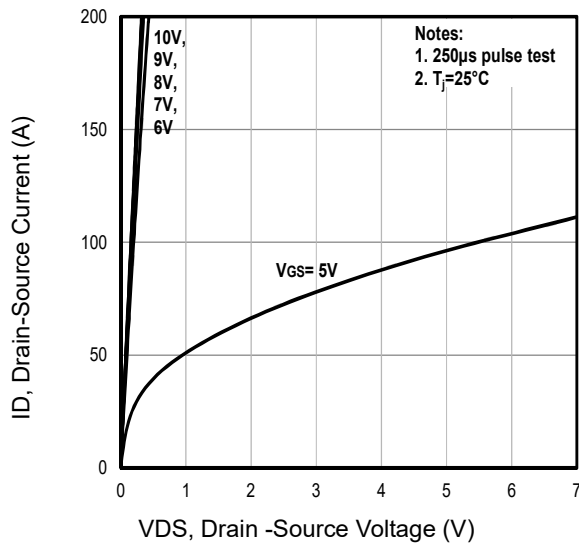

Fig1. Typical Output Characteristics

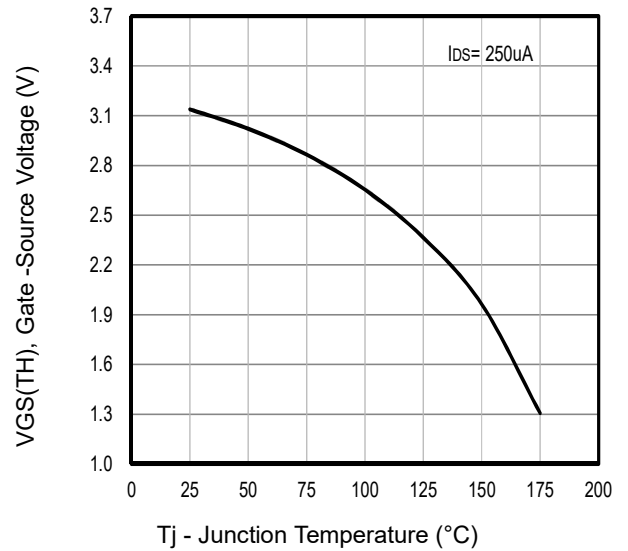

Fig2. $V_{GS(TH)}$ Gate-Source Voltage Vs. T_j

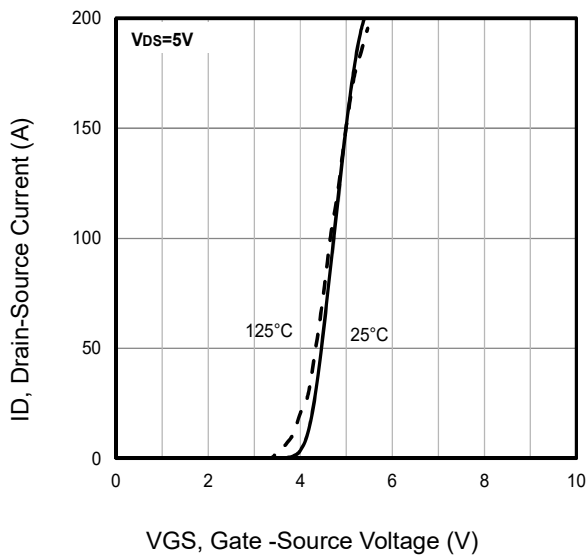

Fig3. Typical Transfer Characteristics

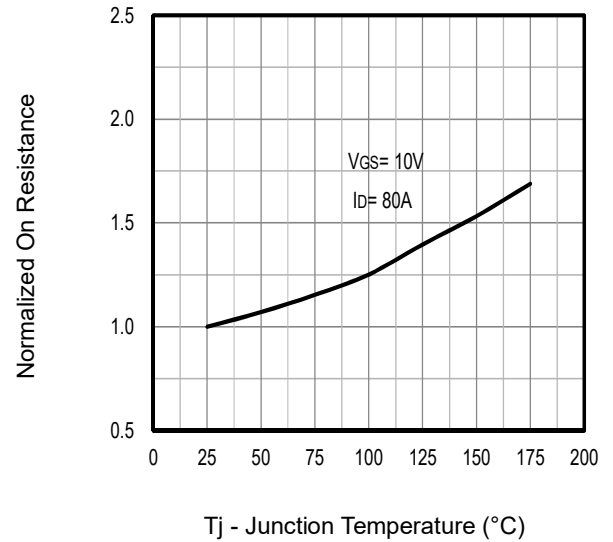

Fig4. Normalized On-Resistance Vs. T_j

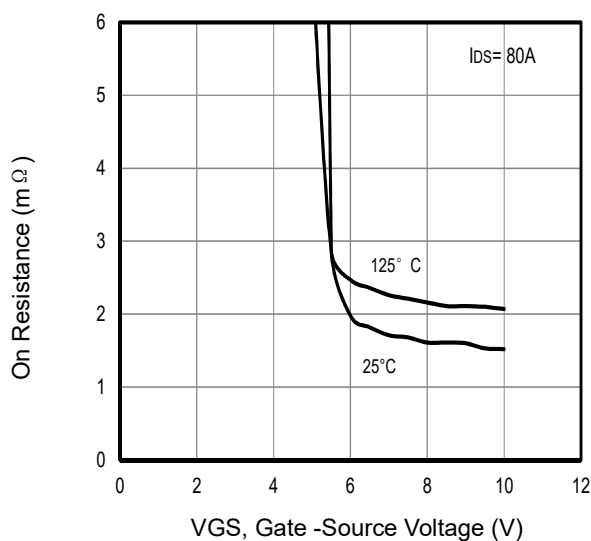

Fig5. On Resistance Vs Gate-Source Voltage

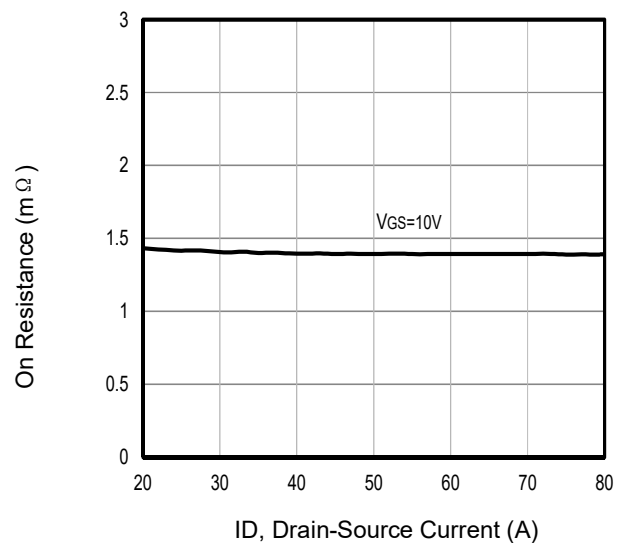

Fig6. On Resistance Vs Drain Current and Gate Voltage

Typical Characteristics

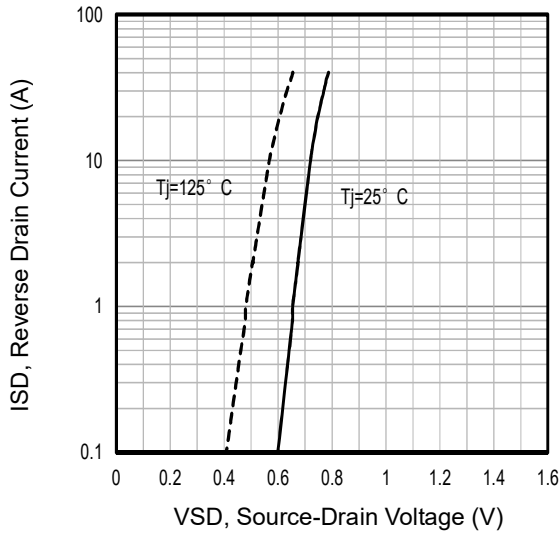

Fig7. Typical Source-Drain Diode Forward Voltage

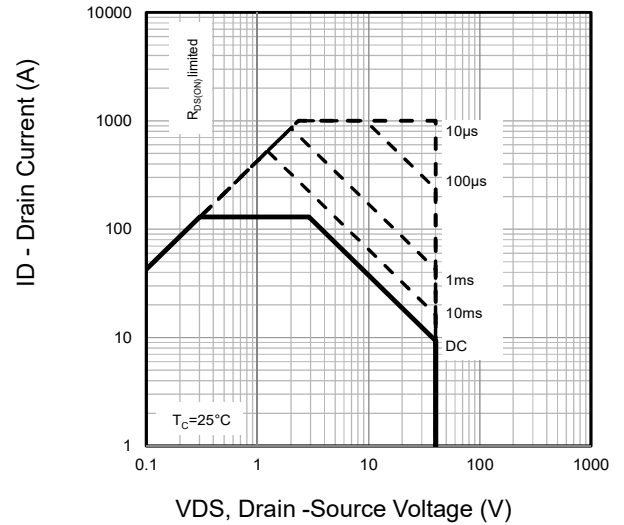

Fig8. Maximum Safe Operating Area

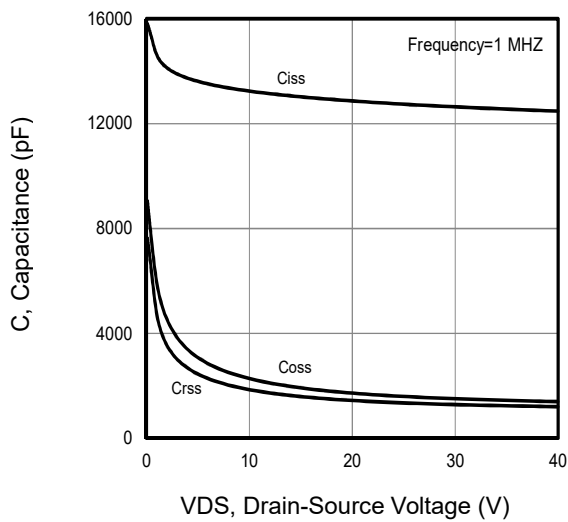

Fig9. Typical Capacitance Vs. Drain-Source Voltage

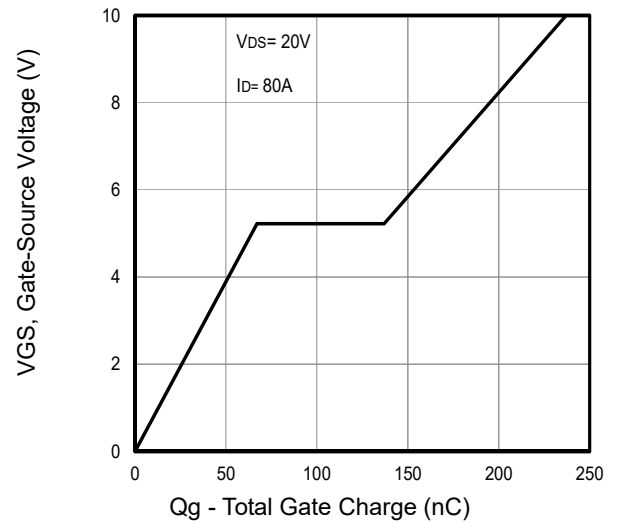

Fig10. Typical Gate Charge Vs. Gate-Source Voltage

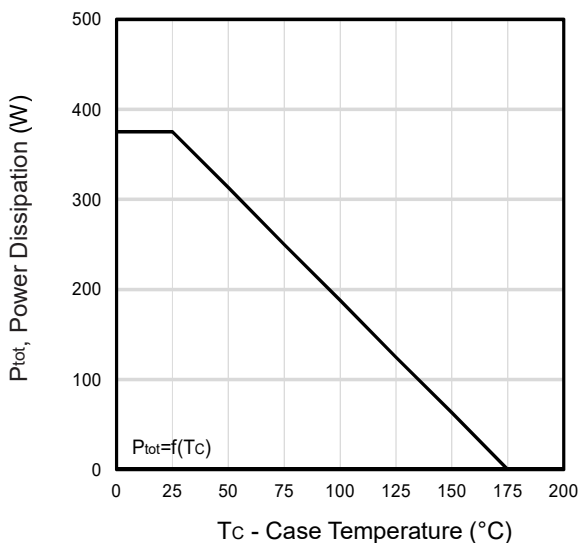

Fig11. Power Dissipation Vs. Case Temperature

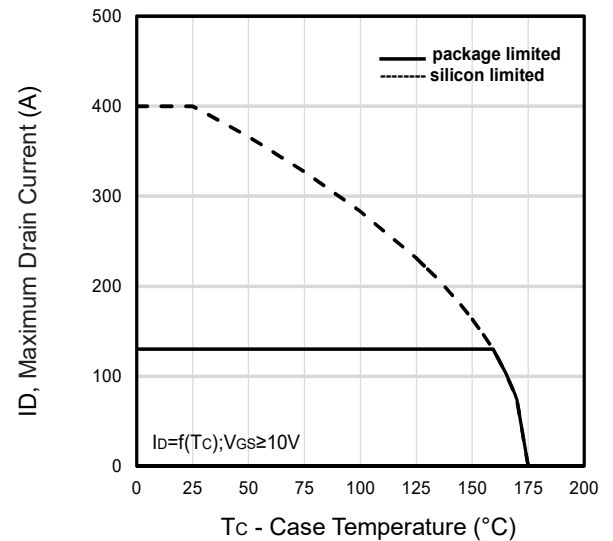

Fig12. Maximum Drain Current Vs. Case Temperature

Typical Characteristics

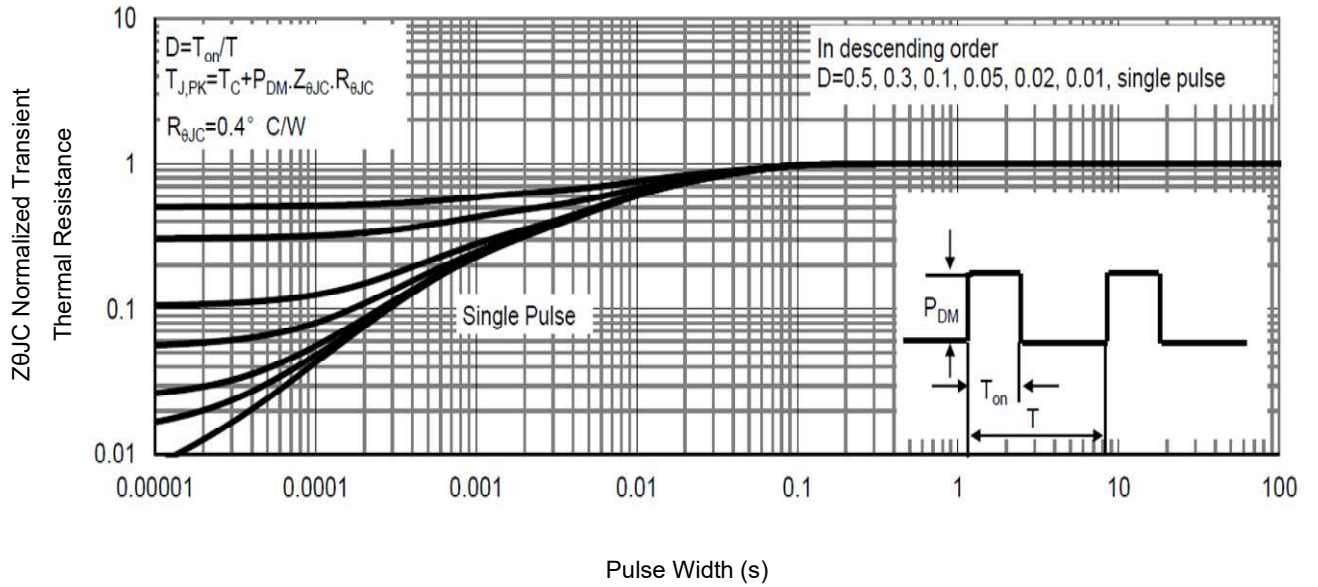

Fig13 . Normalized Maximum Transient Thermal Impedance

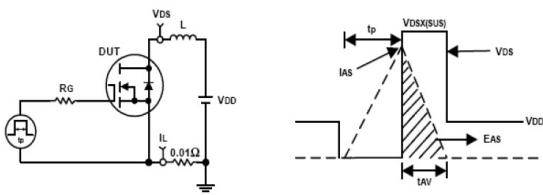

Fig14. Unclamped Inductive Test Circuit and waveforms

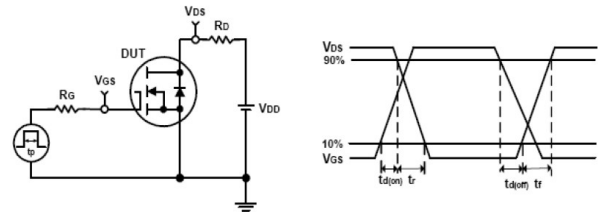
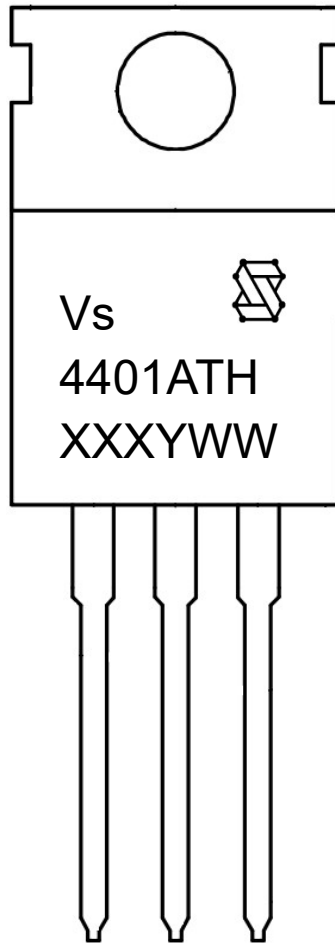

Fig15. Switching Time Test Circuit and waveforms

Marking Information



1st line: Vergiga Code (Vs) ,Vergiga Logo

2nd line: Part Number (4401ATH)

3rd line: Date code (XXXYWW)

XXX: Wafer Lot Number Code , code changed with Lot Number

Y: Year Code, refer to table below

WW: Week Code (01 to 53)

Code	C	D	E	F	G	H	J	K	L	M	N	P	Q	R	S	T
Year	2015	2016	2017	2018	2019	2020	2021	2022	2023	2024	2025	2026	2027	2028	2029	2030

TO-220AB Package Outline Data

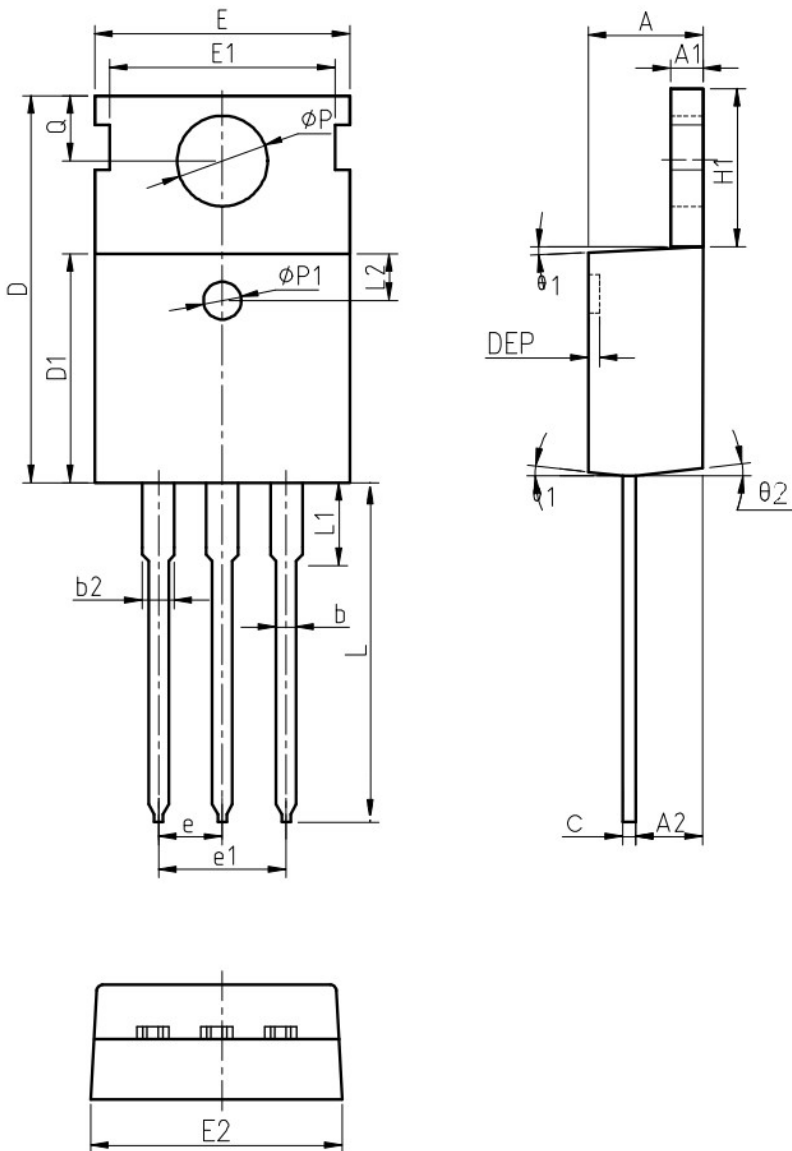

Symbol	Dimensions (unit: mm)		
	Min	Typ	Max
A	4.30	4.52	4.70
A1	1.15	1.30	1.40
A2	2.20	2.40	2.60
b	0.70	0.80	1.00
b2	1.17	1.32	1.50
c	0.45	0.50	0.61
D	15.30	15.65	15.90
D1	9.00	9.20	9.40
DEP	0.05	0.10	0.25
E	9.66	9.90	10.28
E1	-	8.70	-
E2	9.80	10.00	10.20
φP1	1.40	1.50	1.60
e	2.54 BSC		
e1	5.08 BSC		
H1	6.40	6.50	6.80
L	12.70	-	14.27
L1	-	-	3.95
L2	2.40	2.50	2.60
φP	3.53	3.60	3.70
Q	2.70	2.80	2.90
θ1	5 °	7 °	9 °
θ2	1 °	3 °	5 °

Notes:

1. Refer to JEDEC TO-220 variation AB
2. Dimension "D" and "E" do NOT include mold flash. Mold flash shall not exceed 0.127mm per side.

Customer Service

Sales and Service:
sales@vgsemi.com
Vergiga Semiconductor CO., LTD
TEL: (86-755) -26902410

FAX: (86-755) -26907027

WEB: www.vgsemi.com

X-ON Electronics

Largest Supplier of Electrical and Electronic Components

Click to view similar products for [MOSFET](#) category:

Click to view products by [Vanguard](#) manufacturer:

Other Similar products are found below :

[614233C](#) [648584F](#) [IRFD120](#) [IRFF430](#) [JANTX2N5237](#) [2N7000](#) [FCA20N60_F109](#) [FDZ595PZ](#) [AOD464](#) [2SK2267\(Q\)](#) [2SK2545\(Q,T\)](#)
[405094E](#) [423220D](#) [MIC4420CM-TR](#) [VN1206L](#) [614234A](#) [715780A](#) [SSM6J414TU,LF\(T](#) [751625C](#) [PSMN4R2-30MLD](#)
[TK31J60W5,S1VQ\(O](#) [2SK2614\(TE16L1,Q\)](#) [DMN1017UCP3-7](#) [EFC2J004NUZTDG](#) [FCAB21350L1](#) [P85W28HP2F-7071](#) [DMN1053UCP4-7](#)
[NTE2384](#) [NTE2969](#) [NTE6400A](#) [DMN2080UCB4-7](#) [DMN61D9UWQ-13](#) [US6M2GTR](#) [DMN31D5UDJ-7](#) [SSM6P54TU,LF](#) [DMP22D4UFO-](#)
[7B](#) [IPS60R3K4CEAKMA1](#) [DMN1006UCA6-7](#) [DMN16M9UCA6-7](#) [STF5N65M6](#) [STU5N65M6](#) [C3M0021120D](#) [DMN13M9UCA6-7](#)
[BSS340NWH6327XTSA1](#) [MCM3400A-TP](#) [DMTH10H4M6SPS-13](#) [IRF40SC240ARMA1](#) [IPS60R1K0PFD7SAKMA1](#)
[IPS60R360PFD7SAKMA1](#) [IPS60R600PFD7SAKMA1](#)