

Features

- ◆ Low On-Resistance
- ◆ Fast Switching
- ◆ 100% Avalanche Tested
- ◆ Repetitive Avalanche Allowed up to T_{jmax}
- ◆ Lead-Free, RoHS Compliant

Description

VS4410AT designed by the trench processing techniques to achieve extremely low on-resistance. Additional features of this design are a 175°C junction operating temperature, fast switching speed and improved repetitive avalanche rating . These features combine to make this design an extremely efficient and reliable device for use in Motor applications and a wide variety of other applications.

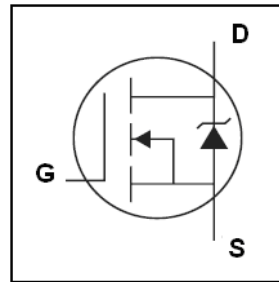

V_{DSS}	100V
$R_{DS(on)}$	6.5m Ω
I_D	110A

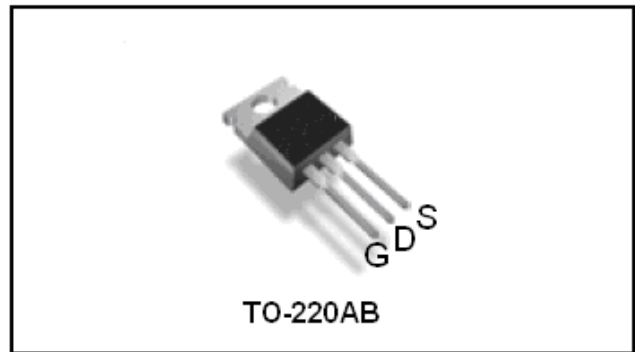
Absolute Maximum Ratings

Stresses beyond those listed under "Absolute Maximum Ratings" may cause permanent damage to the device. These are stress ratings only; and functional operation of the device at these or any other condition beyond those indicated in the specifications is not implied. Exposure to absolute-maximum-rated conditions for extended periods may affect device reliability. The thermal resistance and power dissipation ratings are measured under board mounted and still air conditions. Ambient temperature (T_A) is 25°C, unless otherwise specified.

Symbol	Parameter	Rating	Unit
Common Ratings ($T_C=25^\circ\text{C}$ Unless Otherwise Noted)			
V_{GS}	Gate-Source Voltage	± 20	V
$V_{(BR)DSS}$	Drain-Source Breakdown Voltage	100	V
T_J	Maximum Junction Temperature	175	$^\circ\text{C}$
T_{STG}	Storage Temperature Range	-55 to 175	$^\circ\text{C}$
I_S	Maxium Diode Continuous Forward Current	$T_C=25^\circ\text{C}$ 110	A
Mounted on Large Heat Sink			
I_{DM}	Pulse Drain Current Tested ①	$T_C=25^\circ\text{C}$ 370	A
I_D	Continuous Drain current@ $V_{GS}=10\text{V}$	$T_C=25^\circ\text{C}$ 110	A
P_D	Maximum Power Dissipation	$T_C=25^\circ\text{C}$ 250	W
$R_{\theta JC}$	Thermal Resistance-Junction to Case	0.58	$^\circ\text{C/W}$
$R_{\theta JA}$	Thermal Resistance Junction-Ambient	62.5	$^\circ\text{C/W}$
Drain-Source Avalanche Ratings			
EAS	Avalanche Energy, Single Pulsed ②	900	mJ

Symbol	Parameter	Condition	Min.	Typ.	Max.	Unit
Static Electrical Characteristics @ T_J = 25°C (unless otherwise stated)						
V _{(BR)DSS}	Drain-Source Breakdown Voltage	V _{GS} =0V, I _D =250μA	100	110	--	V
I _{DSS}	Zero Gate Voltage Drain Current(Tc=25°C)	V _{DS} =100V, V _{GS} =0V	--	--	1	μA
	Zero Gate Voltage Drain Current(Tc=125°C)	V _{DS} =100V, V _{GS} =0V	--	--	100	μA
I _{GSS}	Gate-Body Leakage Current	V _{GS} =±20V, V _{DS} =0V	--	--	±100	nA
V _{GS(TH)}	Gate Threshold Voltage	V _{DS} =V _{GS} , I _D =250μA	2	--	4	V
R _{DS(ON)}	Drain-Source On-State Resistance ^③	V _{GS} =10V, I _D =60A	--	6.5	8	mΩ
Dynamic Electrical Characteristics @ T_J = 25°C (unless otherwise stated)						
C _{iss}	Input Capacitance	V _{DS} =50V, V _{GS} =0V, f=1MHz	--	6050	--	pF
C _{oss}	Output Capacitance		--	560	--	pF
C _{rss}	Reverse Transfer Capacitance		--	205	--	pF
Q _g	Total Gate Charge	V _{DS} =50V, I _D =75A, V _{GS} =10V	--	120	--	nC
Q _{gs}	Gate-Source Charge		--	26	--	nC
Q _{gd}	Gate-Drain Charge		--	30	--	nC
Switching Characteristics						
t _{d(on)}	Turn-on Delay Time	V _{DD} =60V, I _D =30A, R _G =2.8Ω, V _{GS} =10V	--	21	--	nS
t _r	Turn-on Rise Time		--	50	--	nS
t _{d(off)}	Turn-Off Delay Time		--	46	--	nS
t _f	Turn-Off Fall Time		--	60	--	nS
Source- Drain Diode Characteristics @ T_J = 25°C (unless otherwise stated)						
I _{SD}	Source-drain current(Body Diode)	T _c =25°C	--	--	110	A
V _{SD}	Forward on voltage	I _{SD} =50A, V _{GS} =0V	--	0.86	1.3	V
t _{rr}	Reverse Recovery Time	T _J =25°C, I _{SD} =75A, V _{GS} =0V	--	50	--	nS
Q _{rr}	Reverse Recovery Charge	di/dt=100A/μs		105		nC

NOTE:

① Pulse width ≤ 300μs; duty cycle ≤ 2%; pulse width limited by max. junction temperature.

② Limited by T_{Jmax}, starting T_J = 25°C, L = 0.5mH, R_G = 25Ω, I_{AS} = 50A, V_{GS} = 10V.



Typical Characteristics

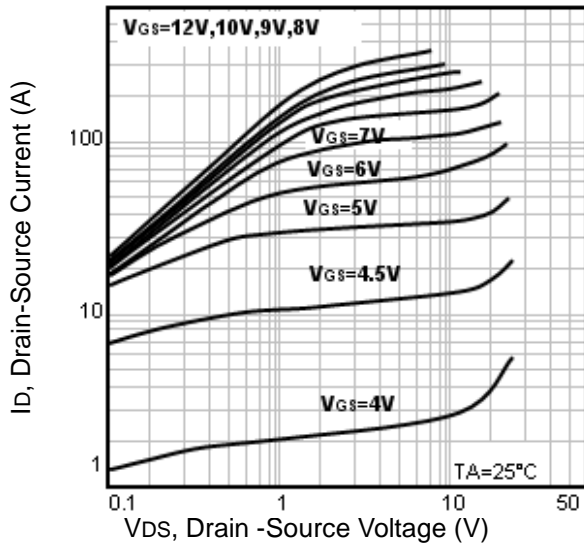

Fig1. Typical Output Characteristics

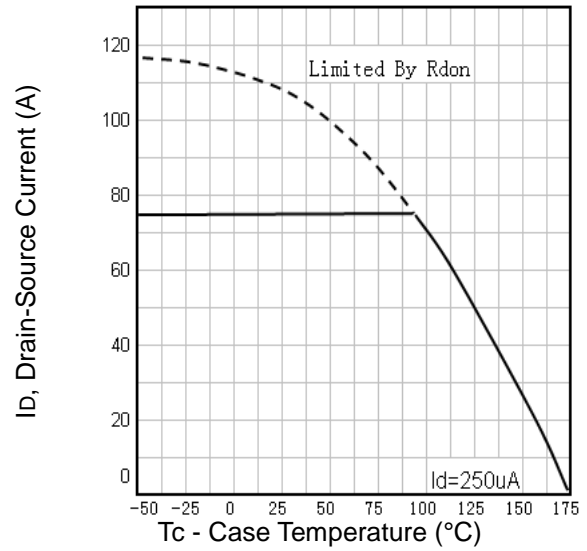

Fig2. Maximum Drain Current Vs. Case Temperature

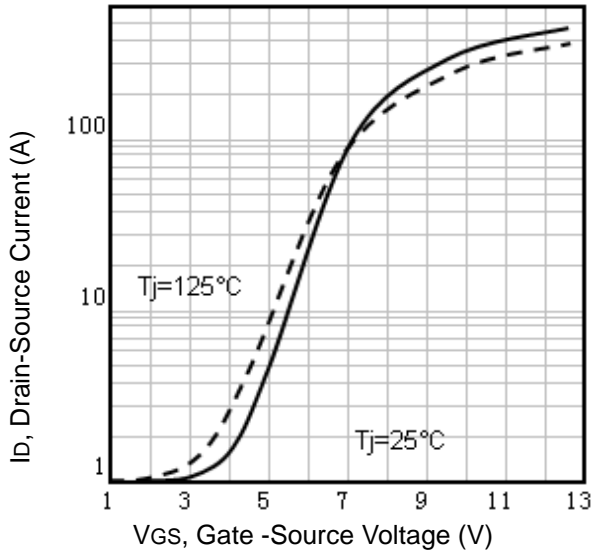

Fig3. Typical Transfer Characteristics

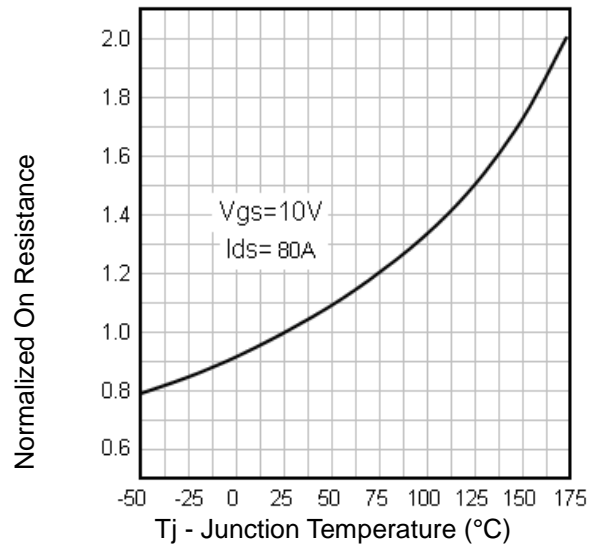

Fig4. Normalized On-Resistance Vs. Temperature

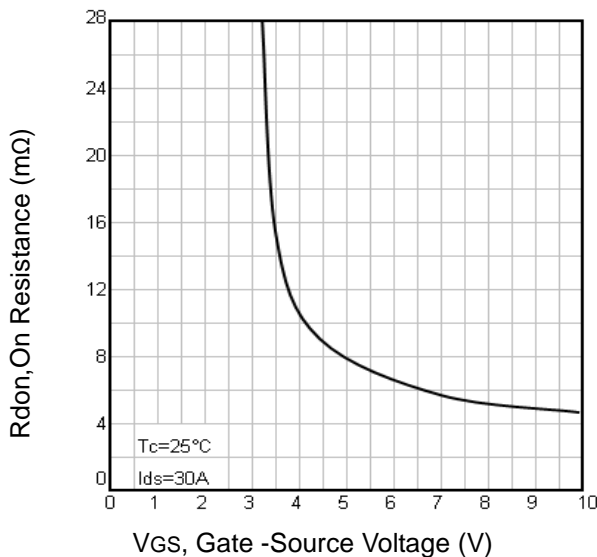

Fig5. Typical On-Resistance Vs. Gate-Source Voltage

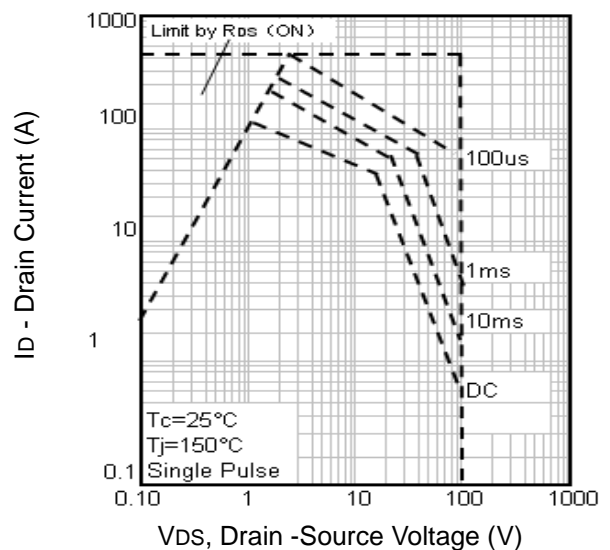

Fig6. Maximum Safe Operating Area

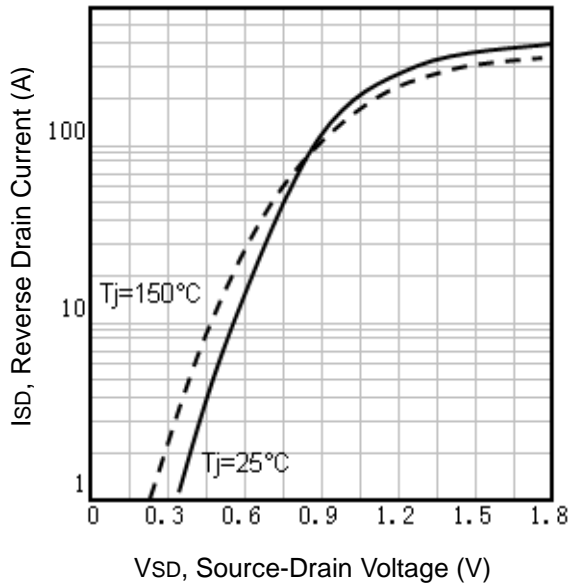

Fig7. Typical Source-Drain Diode Forward Voltage

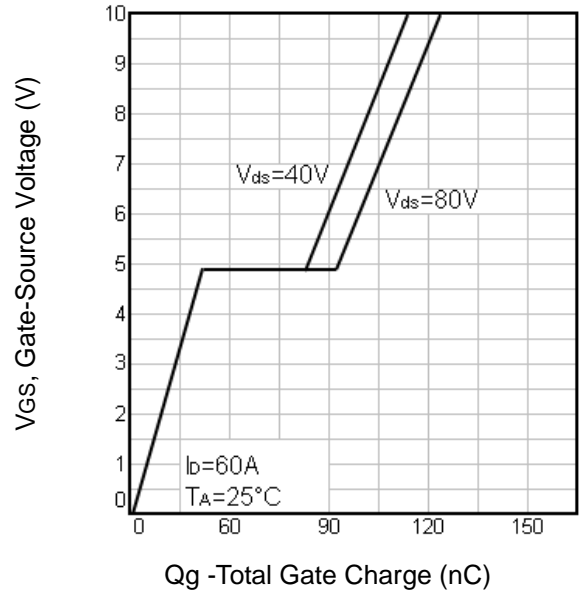

Fig8. Typical Gate Charge Vs. Gate-Source Voltage

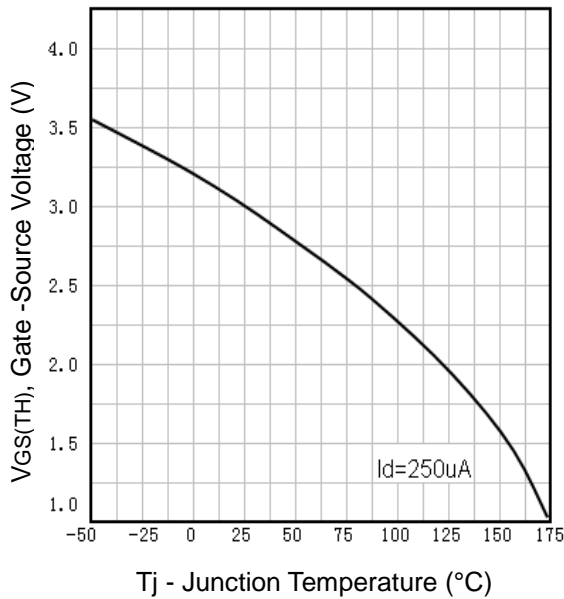

Fig9. Threshold Voltage Vs. Temperature

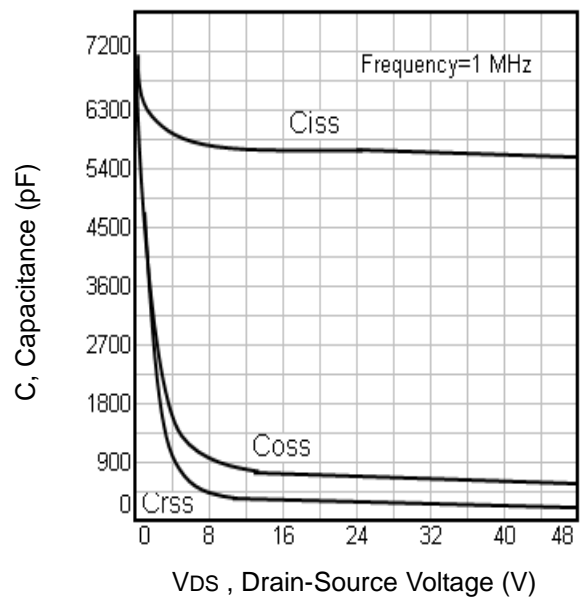

Fig10. Typical Capacitance Vs. Drain-Source Voltage

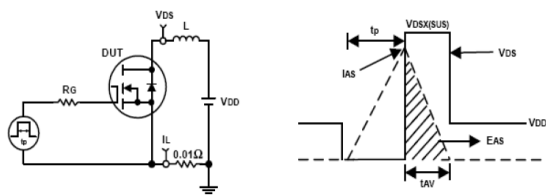

Fig11. Unclamped Inductive Test Circuit and waveforms

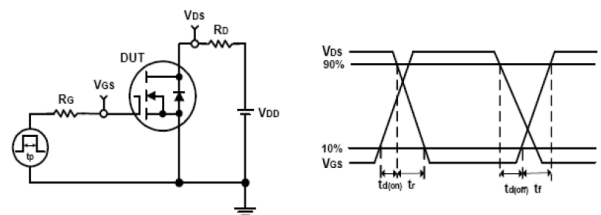
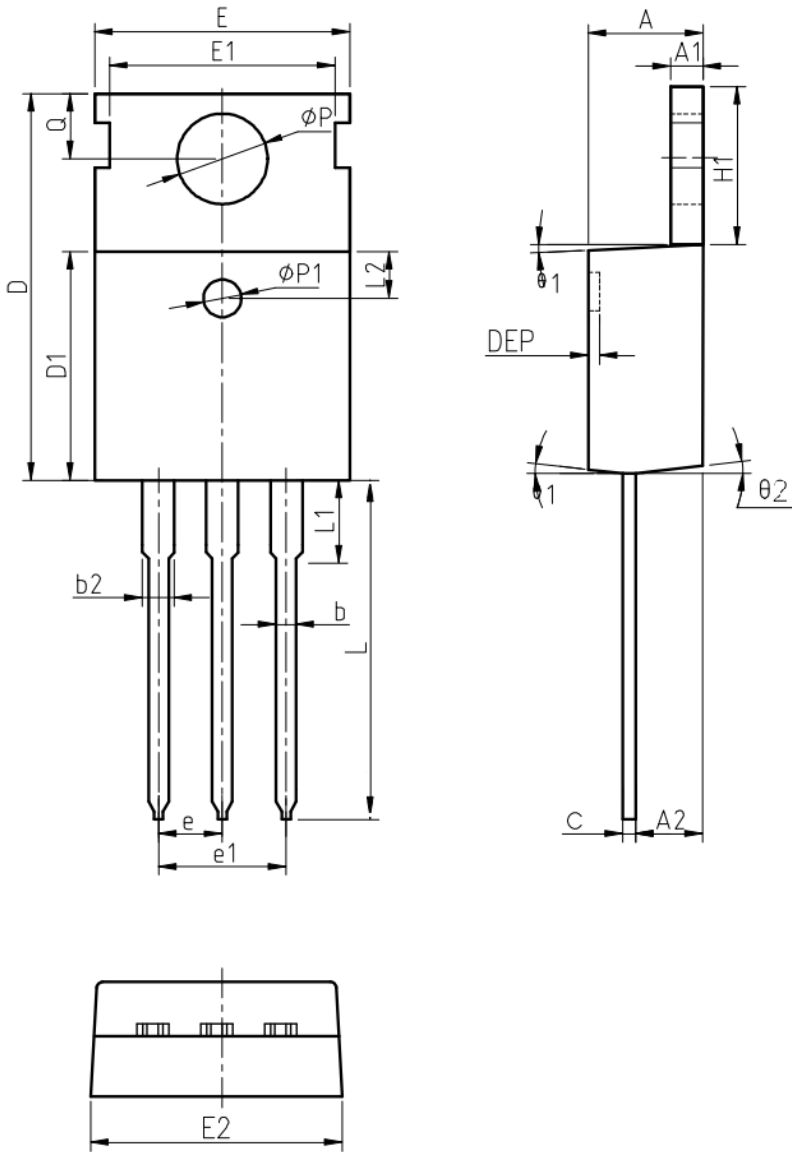

Fig12. Switching Time Test Circuit and waveforms

TO-220AB Package Outline Data



Symbol	Dimensions (unit: mm)		
	Min	Typ	Max
A	4.30	4.52	4.70
A1	1.15	1.30	1.40
A2	2.20	2.40	2.60
b	0.70	0.80	1.00
b2	1.17	1.32	1.50
c	0.45	0.50	0.61
D	15.30	15.65	15.90
D1	9.00	9.20	9.40
DEP	0.05	0.10	0.25
E	9.66	9.90	10.28
E1	-	8.70	-
E2	9.80	10.00	10.20
$\phi P1$	1.40	1.50	1.60
e	2.54 BSC		
e1	5.08 BSC		
H1	6.40	6.50	6.80
L	12.70	-	14.27
L1	-	-	3.95
L2	2.40	2.50	2.60
ϕP	3.53	3.60	3.70
Q	2.70	2.80	2.90
$\theta1$	5 °	7 °	9 °
$\theta2$	1 °	3 °	5 °

Notes:

1. Refer to JEDEC TO-220 variation AB
2. Dimension "D" and "E" do NOT include mold flash. Mold flash shall not exceed 0.127mm per side.

Customer Service

Sales and Service:

sales@vgsemi.com

Vanguard Semiconductor CO., LTD

TEL: (86-755) -26902410

FAX: (86-755) -26907027

WEB: www.vgsemi.com

X-ON Electronics

Largest Supplier of Electrical and Electronic Components

Click to view similar products for [MOSFET](#) category:

Click to view products by [Vanguard](#) manufacturer:

Other Similar products are found below :

[614233C](#) [648584F](#) [MCH3443-TL-E](#) [MCH6422-TL-E](#) [FDPF9N50NZ](#) [FW216A-TL-2W](#) [FW231A-TL-E](#) [APT5010JVR](#) [NTNS3A92PZT5G](#)
[IRF100S201](#) [JANTX2N5237](#) [2SK2464-TL-E](#) [2SK3818-DL-E](#) [FCA20N60_F109](#) [FDZ595PZ](#) [STD6600NT4G](#) [FSS804-TL-E](#) [2SJ277-DL-E](#)
[2SK1691-DL-E](#) [2SK2545\(Q,T\)](#) [D2294UK](#) [405094E](#) [423220D](#) [MCH6646-TL-E](#) [TPCC8103,L1Q\(CM](#) [367-8430-0972-503](#) [VN1206L](#)
[424134F](#) [026935X](#) [051075F](#) [SBVS138LT1G](#) [614234A](#) [715780A](#) [NTNS3166NZT5G](#) [751625C](#) [873612G](#) [IRF7380TRHR](#)
[IPS70R2K0CEAKMA1](#) [RJK60S3DPP-E0#T2](#) [RJK60S5DPK-M0#T0](#) [APT5010JVFR](#) [APT12031JFLL](#) [APT12040JVR](#) [DMN3404LQ-7](#)
[NTE6400](#) [JANTX2N6796U](#) [JANTX2N6784U](#) [JANTXV2N5416U4](#) [SQM110N05-06L-GE3](#) [SIHF35N60E-GE3](#)