

Features

- N-Channel, 5V Logic Level Control
- Enhancement mode
- Very low on-resistance $R_{DS(on)}$ @ $V_{GS}=4.5\text{ V}$
- 100% Avalanche test
- Pb-free lead plating; RoHS compliant

V_{DS}	40	V
$R_{DS(on),TYP} @ V_{GS}=10\text{ V}$	2.7	m Ω
$R_{DS(on),TYP} @ V_{GS}=4.5\text{ V}$	3.7	m Ω
I_D	125	A



PDFN5x6



Drain Pin 5-8



Source Pin 1-3

Part ID	Package Type	Marking	Tape and reel information
VS4604AP	PDFN5x6	4604AP	3000PCS/Reel

Maximum ratings, at $T_A = 25^\circ\text{C}$, unless otherwise specified

Symbol	Parameter	Rating	Unit
$V_{(BR)DSS}$	Drain-Source breakdown voltage	40	V
V_{GS}	Gate-Source voltage	± 20	V
I_S	Diode continuous forward current	$T_C = 25^\circ\text{C}$	125 A
I_D	Continuous drain current @ $V_{GS}=10\text{V}$	$T_C = 25^\circ\text{C}$	125 A
		$T_C = 100^\circ\text{C}$	79 A
I_{DSM}	Continuous drain current @ $V_{GS}=10\text{V}$	$T_A = 25^\circ\text{C}$	32 A
		$T_A = 70^\circ\text{C}$	26 A
I_{DM}	Pulse drain current tested ①	$T_C = 25^\circ\text{C}$	500 A
EAS	Avalanche energy, single pulsed ②	72	mJ
P_D	Maximum power dissipation	$T_C = 25^\circ\text{C}$	63 W
P_{DSM}	Maximum power dissipation ③	$T_A = 25^\circ\text{C}$	4 W
MSL		Level 1	
T_{STG}, T_J	Storage and Junction Temperature Range	-55 to 150	$^\circ\text{C}$

Thermal Characteristics

Symbol	Parameter	Typical	Unit
$R_{\theta JC}$	Thermal Resistance, Junction-to-Case	2	$^\circ\text{C/W}$
$R_{\theta JA}$	Thermal Resistance, Junction-to-Ambient	30	$^\circ\text{C/W}$

Symbol	Parameter	Condition	Min.	Typ.	Max.	Unit
Static Electrical Characteristics @ T_j=25°C (unless otherwise stated)						
V _{(BR)DSS}	Drain-Source Breakdown Voltage	V _{GS} =0V, I _D =250μA	40	--	--	V
I _{DSS}	Zero Gate Voltage Drain Current	V _{DS} =40V, V _{GS} =0V	--	--	1	μA
	Zero Gate Voltage Drain Current(T _j =125°C)	V _{DS} =40V, V _{GS} =0V	--	--	100	μA
I _{GSS}	Gate-Body Leakage Current	V _{GS} =±20V, V _{DS} =0V	--	--	±100	nA
V _{GS(TH)}	Gate Threshold Voltage	V _{DS} =V _{GS} , I _D =250μA	1.3	1.6	2.4	V
R _{DS(ON)}	Drain-Source On-State Resistance④	V _{GS} =10V, I _D =20A	--	2.7	4	mΩ
R _{DS(ON)}	Drain-Source On-State Resistance④	V _{GS} =4.5V, I _D =15A	--	3.7	5	mΩ
Dynamic Electrical Characteristics @ T_j = 25°C (unless otherwise stated)						
C _{iss}	Input Capacitance	V _{DS} =20V, V _{GS} =0V, f=1MHz	4500	5015	5500	pF
C _{oss}	Output Capacitance		350	440	550	pF
C _{rss}	Reverse Transfer Capacitance		300	380	450	pF
R _g	Gate Resistance	f=1MHz	--	2.3	--	Ω
Q _g	Total Gate Charge	V _{DS} =20V, I _D =20A, V _{GS} =10V	--	83	--	nC
Q _{gs}	Gate-Source Charge		--	16	--	nC
Q _{gd}	Gate-Drain Charge		--	17	--	nC
Switching Characteristics						
t _{d(on)}	Turn-on Delay Time	V _{DD} =20V, I _D =20A, R _G =3Ω, V _{GS} =10V	--	15.7	--	nS
t _r	Turn-on Rise Time		--	6.5	--	nS
t _{d(off)}	Turn-Off Delay Time		--	56	--	nS
t _f	Turn-Off Fall Time		--	12	--	nS
Source- Drain Diode Characteristics @ T_j = 25°C (unless otherwise stated)						
V _{SD}	Forward on voltage	I _{SD} =20A, V _{GS} =0V	--	0.8	1.2	V
t _{rr}	Reverse Recovery Time	T _j =25°C, I _{sd} =20A, V _{GS} =0V di/dt=500A/μs	--	18	--	nS
Q _{rr}	Reverse Recovery Charge		40	--	--	nC

NOTE:

- ① Repetitive rating; pulse width limited by max junction temperature.
- ② Limited by T_{Jmax}, starting T_J = 25°C, L = 0.5mH, R_G = 25Ω, I_{AS} = 17A, V_{GS} = 10V. Part not recommended for use above this value
- ③ The power dissipation P_{DSM} is based on R_{θJA} and the maximum allowed junction temperature of 150°C.
- ④ Pulse width ≤ 300μs; duty cycles ≤ 2%.

Typical Characteristics

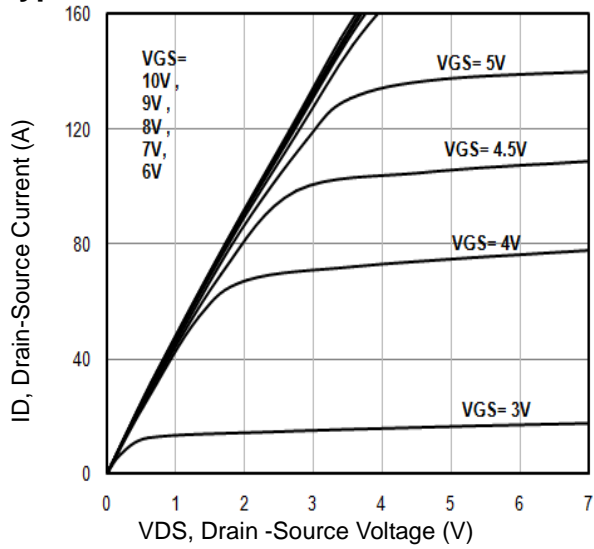

Fig1. Typical Output Characteristics

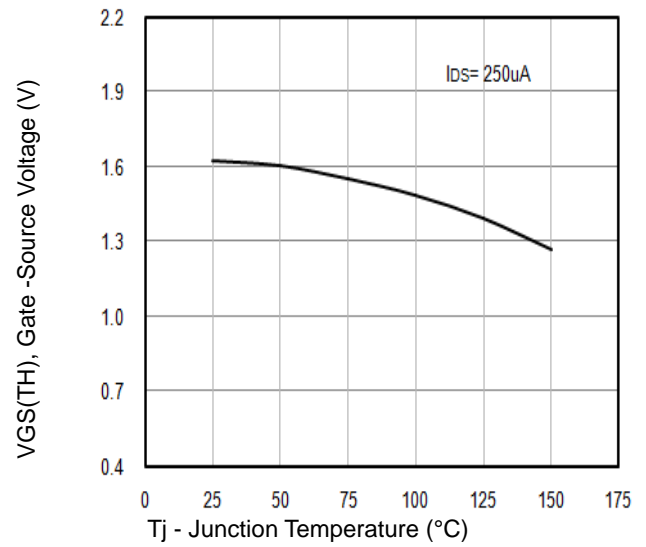

Fig2. $V_{GS(TH)}$ Gate -Source Voltage Vs. T_j

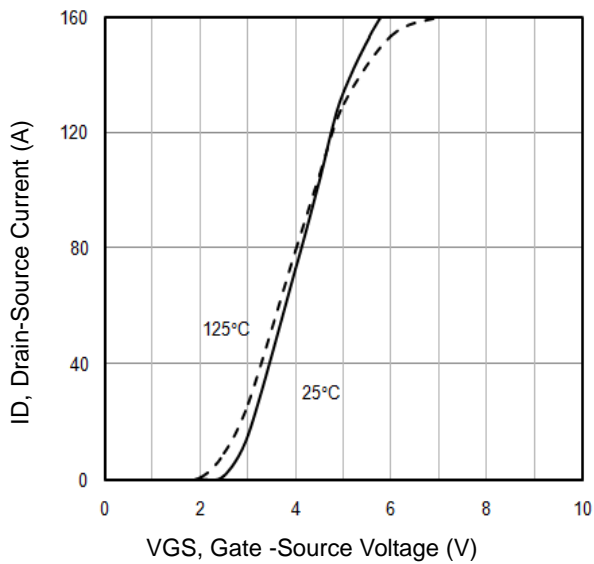

Fig3. Typical Transfer Characteristics

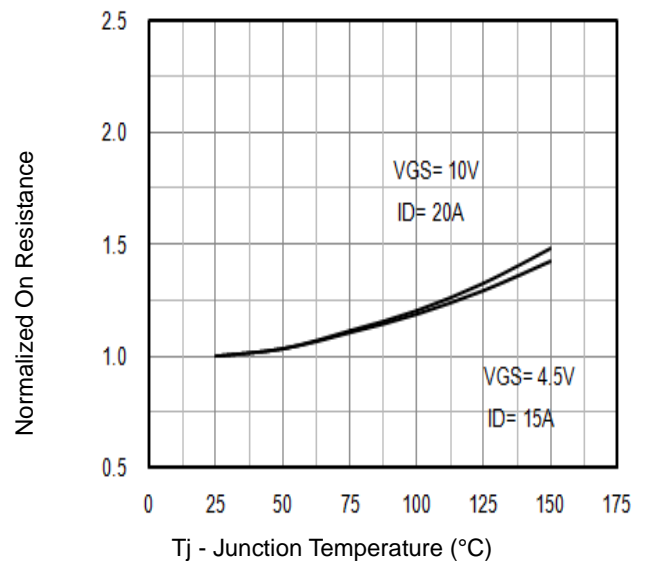

Fig4. Normalized On-Resistance Vs. T_j

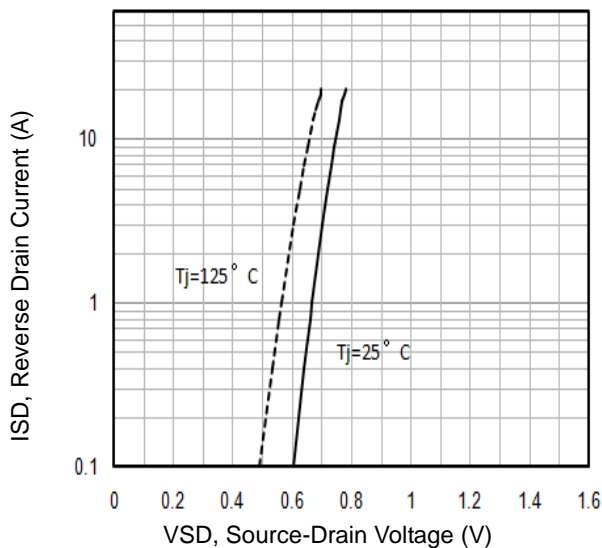

Fig5. Typical Source-Drain Diode Forward Voltage

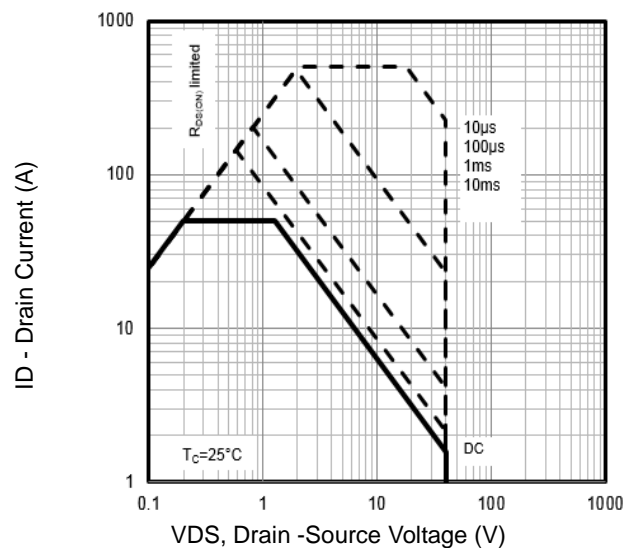

Fig6. Maximum Safe Operating Area

Typical Characteristics

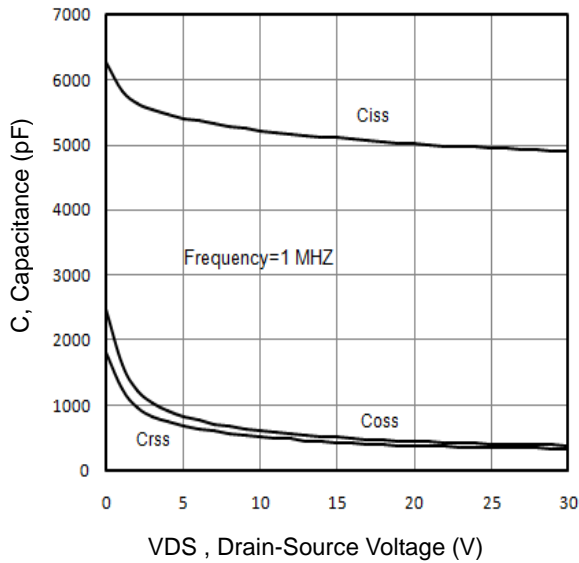

Fig7. Typical Capacitance Vs.Drain-Source Voltage

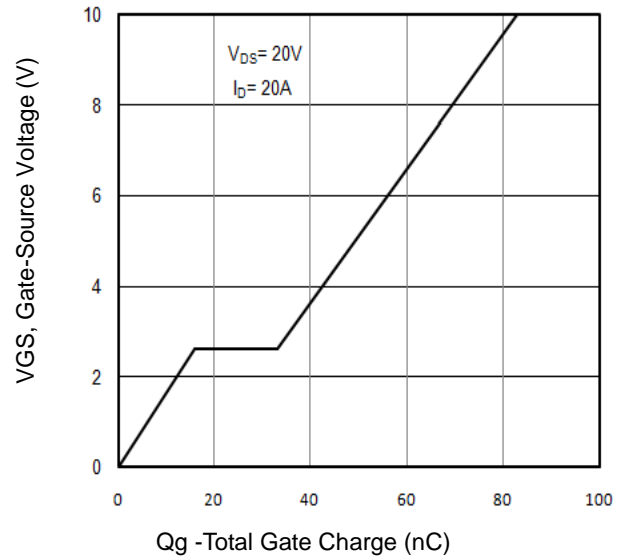

Fig8. Typical Gate Charge Vs.Gate-Source Voltage

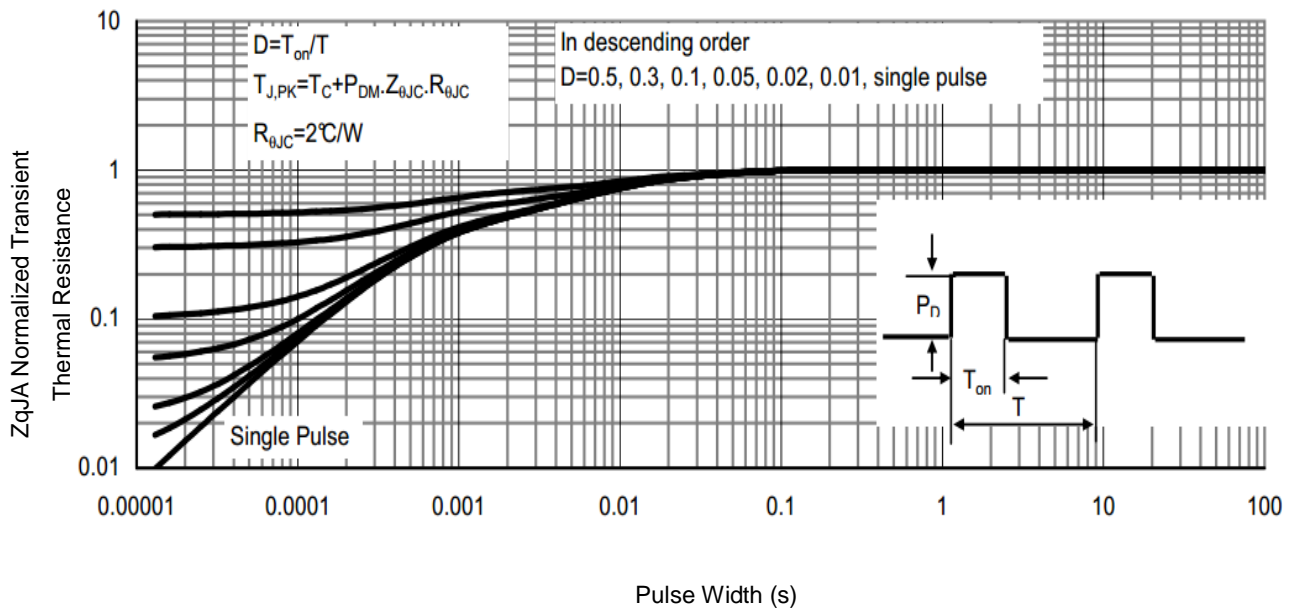

Fig9. Normalized Maximum Transient Thermal Impedance

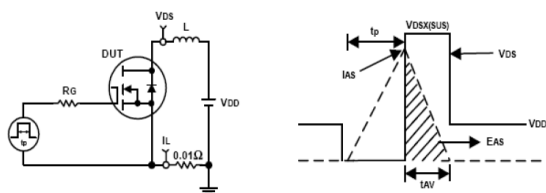

Fig10. Unclamped Inductive Test Circuit and waveforms

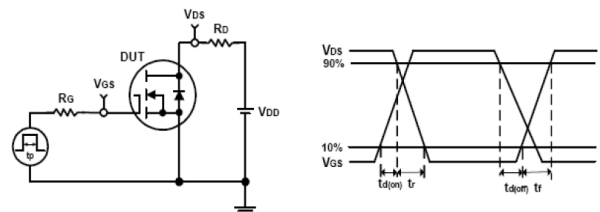
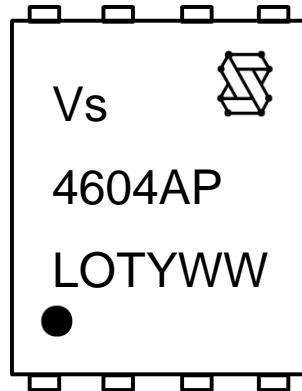

Fig11. Switching Time Test Circuit and waveforms

Marking Information



- 1st line: Vanguard Code (Vs), Vanguard Logo
2nd line: Part Number (4604AP)
3rd line: Date code (LOTYWW)
LOT: Wafer Lot Number
Y: Year Code, e.g. E means 2017
WW: Week Code

PDFN5×6 Package Outline Data

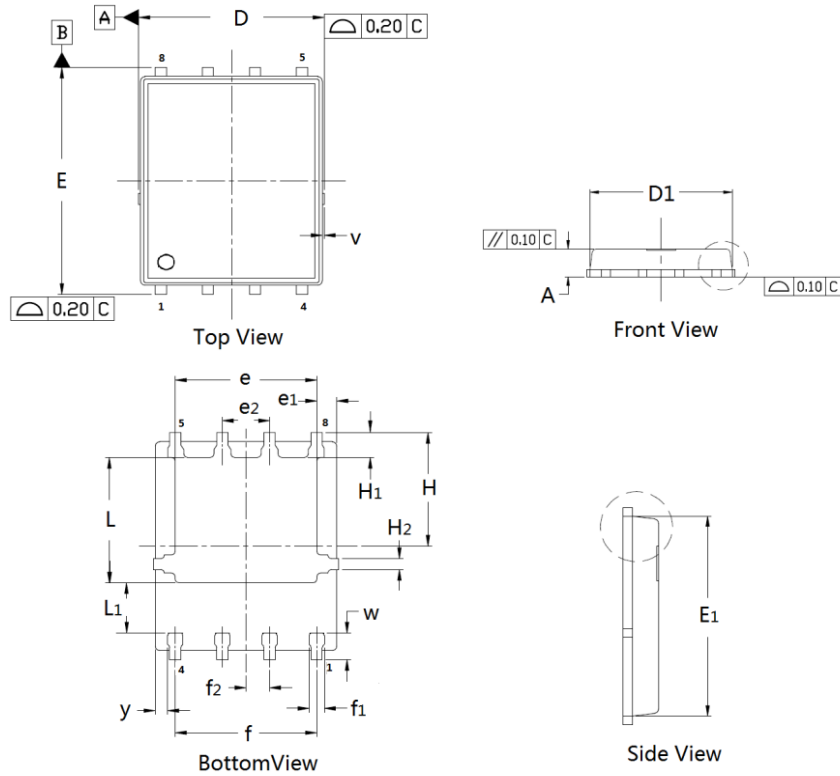

DIMENSIONS (unit : mm)

Symbol	Min	Typ	Max	Symbol	Min	Typ	Max
A	0.90	1.02	1.10	D	4.90	4.98	5.10
D ₁	4.80	4.89	5.00	E	6.00	6.11	6.20
E ₁	5.65	5.74	5.85	e	3.72	3.80	3.92
e ₁	--	0.54	--	e ₂	--	1.27	--
f	--	3.82	--	f ₁	0.31	0.37	0.51
f ₂	--	0.64	--	H	--	3.15	--
H ₁	0.59	0.63	0.79	H ₂	0.26	0.28	0.32
L	3.38	3.45	3.58	L ₁	--	1.39	--
v	--	0.13	--	w	0.64	0.68	0.84
y	--	0.34	--		--		--

Customer Service

Sales and Service:

sales@vgsemi.com

Vanguard Semiconductor CO., LTD

TEL: (86-755) -26902410

FAX: (86-755) -26907027

WEB: www.vgsemi.com

X-ON Electronics

Largest Supplier of Electrical and Electronic Components

Click to view similar products for [MOSFET](#) category:

Click to view products by [Vanguard](#) manufacturer:

Other Similar products are found below :

[614233C](#) [648584F](#) [MCH3443-TL-E](#) [MCH6422-TL-E](#) [FDPF9N50NZ](#) [FW216A-TL-2W](#) [FW231A-TL-E](#) [APT5010JVR](#) [NTNS3A92PZT5G](#)
[IRF100S201](#) [JANTX2N5237](#) [2SK2464-TL-E](#) [2SK3818-DL-E](#) [FCA20N60_F109](#) [FDZ595PZ](#) [STD6600NT4G](#) [FSS804-TL-E](#) [2SJ277-DL-E](#)
[2SK1691-DL-E](#) [2SK2545\(Q,T\)](#) [D2294UK](#) [405094E](#) [423220D](#) [MCH6646-TL-E](#) [TPCC8103,L1Q\(CM](#) [367-8430-0972-503](#) [VN1206L](#)
[424134F](#) [026935X](#) [051075F](#) [SBVS138LT1G](#) [614234A](#) [715780A](#) [NTNS3166NZT5G](#) [751625C](#) [873612G](#) [IRF7380TRHR](#)
[IPS70R2K0CEAKMA1](#) [RJK60S3DPP-E0#T2](#) [RJK60S5DPK-M0#T0](#) [APT5010JVFR](#) [APT12031JFLL](#) [APT12040JVR](#) [DMN3404LQ-7](#)
[NTE6400](#) [JANTX2N6796U](#) [JANTX2N6784U](#) [JANTXV2N5416U4](#) [SQM110N05-06L-GE3](#) [SIHF35N60E-GE3](#)