

Features

- Enhancement mode
- VitoMOS[®] II Technology
- Fast Switching and High efficiency
- 100% Avalanche test

V_{DS}	40	V
$R_{DS(on),TYP@ V_{GS}=10V}$	6.4	mΩ
$R_{DS(on),TYP@ V_{GS}=4.5V}$	10	mΩ
$I_{D(Silicon Limited)}$	54	A
$I_{D(Package Limited)}$	36	A

PDFN3333

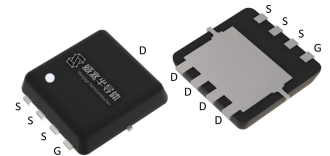

Part ID	Package Type	Marking	Packing
VS4620GEMC	PDFN3333	4620GE	5000PCS/Reel

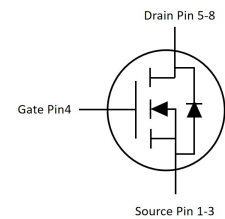

Maximum ratings, at $T_A = 25^\circ\text{C}$, unless otherwise specified

Symbol	Parameter	Rating	Unit
$V_{(BR)DSS}$	Drain-Source breakdown voltage	40	V
V_{GS}	Gate-Source voltage	± 20	V
I_S	Diode continuous forward current	$T_C = 25^\circ\text{C}$ 54	A
I_D	Continuous drain current @ $V_{GS}=10V$ (Silicon limited)	$T_C = 25^\circ\text{C}$ 54	A
I_D	Continuous drain current @ $V_{GS}=10V$ (Silicon limited)	$T_C = 100^\circ\text{C}$ 34	A
I_D	Continuous drain current @ $V_{GS}=10V$ (Wire bond limited)	$T_C = 25^\circ\text{C}$ 36	A
I_{DM}	Pulse drain current tested ①	$T_C = 25^\circ\text{C}$ 150	A
I_{DSM}	Continuous drain current @ $V_{GS}=10V$	$T_A = 25^\circ\text{C}$ 19	A
		$T_A = 70^\circ\text{C}$ 15	A
E_{AS}	Avalanche energy, single pulsed ②	16	mJ
PD	Maximum power dissipation	$T_C = 25^\circ\text{C}$ 30	W
		$T_C = 100^\circ\text{C}$ 12	W
P_{DSM}	Maximum power dissipation ③	$T_A = 25^\circ\text{C}$ 3.6	W
		$T_A = 70^\circ\text{C}$ 2.3	W
$T_{STG,TJ}$	Storage and Junction Temperature Range	-55 to 150	$^\circ\text{C}$

Thermal Characteristics

Symbol	Parameter	Typical	Max	Unit
$R_{\theta JC}$	Thermal Resistance, Junction-to-Case	4.2	5	$^\circ\text{C/W}$
$R_{\theta JA}$	Thermal Resistance, Junction-to-Ambient	35	42	$^\circ\text{C/W}$

Electrical Characteristics

Symbol	Parameter	Condition	Min.	Typ.	Max.	Unit
Static Electrical Characteristics @ T_j=25°C (unless otherwise stated)						
V(BR)DSS	Drain-Source Breakdown Voltage	V _{GS} =0V, I _D =250μA	40	45	--	V
I _{DSS}	Zero Gate Voltage Drain Current(T _j =25°C)	V _{DS} =40V, V _{GS} =0V	--	--	1	μA
	Zero Gate Voltage Drain Current(T _j =125°C)	V _{DS} =40V, V _{GS} =0V	--	--	100	μA
I _{GSS}	Gate-Body Leakage Current	V _{GS} =±20V, V _{DS} =0V	--	--	±100	nA
V _{GS(th)}	Gate Threshold Voltage	V _{DS} =V _{GS} , I _D =250μA	1.1	1.65	2.3	V
R _{DS(on)}	Drain-Source On-State Resistance ④	V _{GS} =10V, I _D =20A	--	6.4	8.3	mΩ
		(T _j =100°C)	--	7.8	--	mΩ
R _{DS(on)}	Drain-Source On-State Resistance ④	V _{GS} =4.5V, I _D =10A	--	10	13	mΩ
Dynamic Electrical Characteristics @ T_j = 25°C (unless otherwise stated)						
C _{iss}	Input Capacitance	V _{DS} =20V, V _{GS} =0V, f=1MHz	550	735	980	pF
C _{oss}	Output Capacitance		215	285	380	pF
C _{rss}	Reverse Transfer Capacitance		15	25	60	pF
R _g	Gate Resistance	f=1MHz	0.2	1.7	5	Ω
Q _{g(10V)}	Total Gate Charge	V _{DS} =20V, I _D =20A, V _{GS} =10V	--	15	20	nC
Q _{g(4.5V)}	Total Gate Charge		--	7.6	10	nC
Q _{gs}	Gate-Source Charge		--	3	4	nC
Q _{gd}	Gate-Drain Charge		--	3.3	5	nC
Switching Characteristics						
T _{d(on)}	Turn-on Delay Time	V _{DD} =20V, I _D =20A, R _G =3Ω, V _{GS} =10V	--	5.6	--	ns
T _r	Turn-on Rise Time		--	47	--	ns
T _{d(off)}	Turn-Off Delay Time		--	15	--	ns
T _f	Turn-Off Fall Time		--	6.4	--	ns
Source- Drain Diode Characteristics@ T_j = 25°C (unless otherwise stated)						
V _{SD}	Forward on voltage	I _{SD} =20A, V _{GS} =0V	--	0.9	1.2	V
T _{rr}	Reverse Recovery Time	I _{sd} =20A, V _{GS} =0V di/dt=100A/μs	--	6.1	12	ns
Q _{rr}	Reverse Recovery Charge		--	0.6	1.2	nC

NOTE: ① Single pulse; pulse width ≤ 100μs.

② Limited by T_{Jmax}, starting T_J = 25°C, L = 0.5mH, R_G = 25Ω, I_{AS} = 8A, V_{GS} = 10V. Part not recommended for use above this value

③ The power dissipation P_{DSM} is based on R_{θJA} and the maximum allowed junction temperature of 150°C.

④ Pulse width ≤ 380μs; duty cycle ≤ 2%.

Typical Characteristics

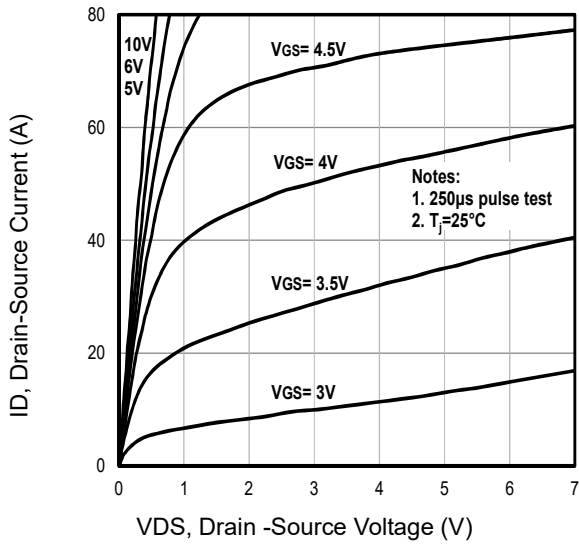

Fig1. Typical Output Characteristics

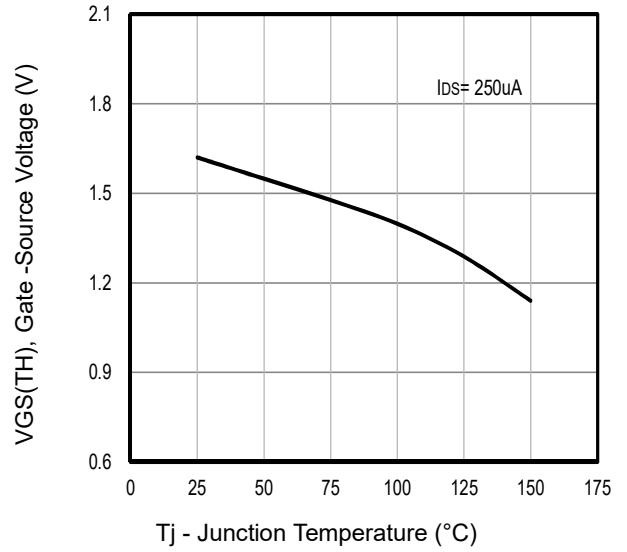

Fig2. VGS(TH) Gate-Source Voltage Vs. Tj

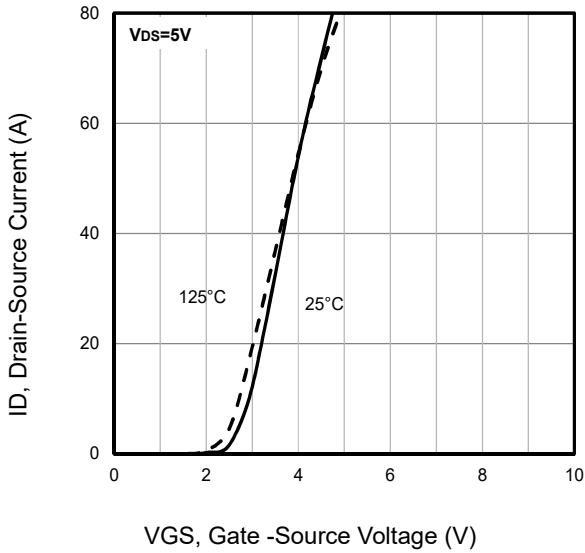

Fig3. Typical Transfer Characteristics

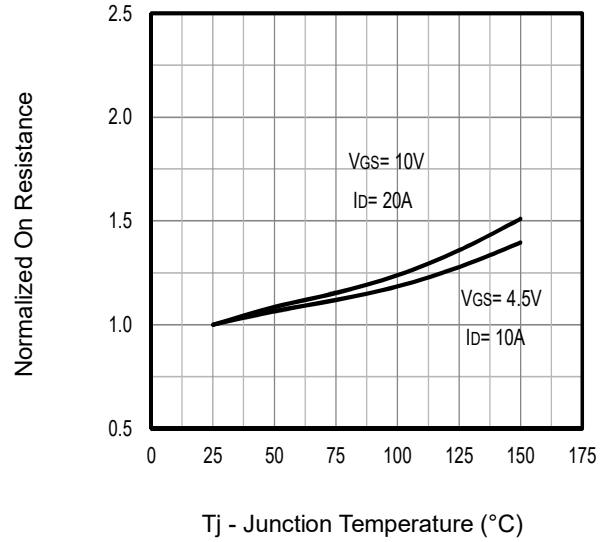

Fig4. Normalized On-Resistance Vs. Tj

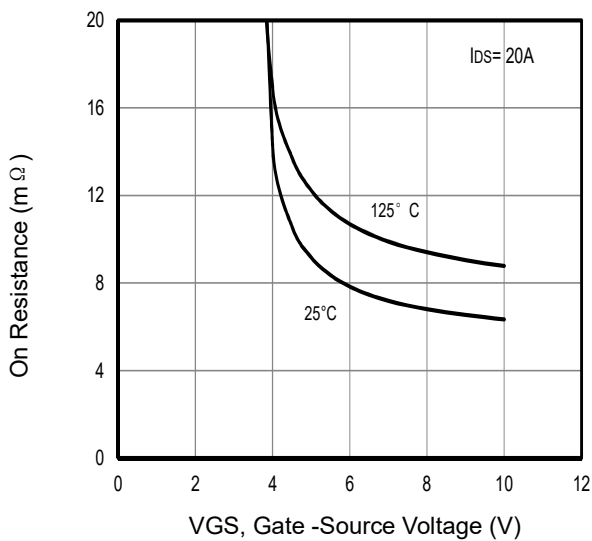

Fig5. On Resistance Vs Gate-Source Voltage

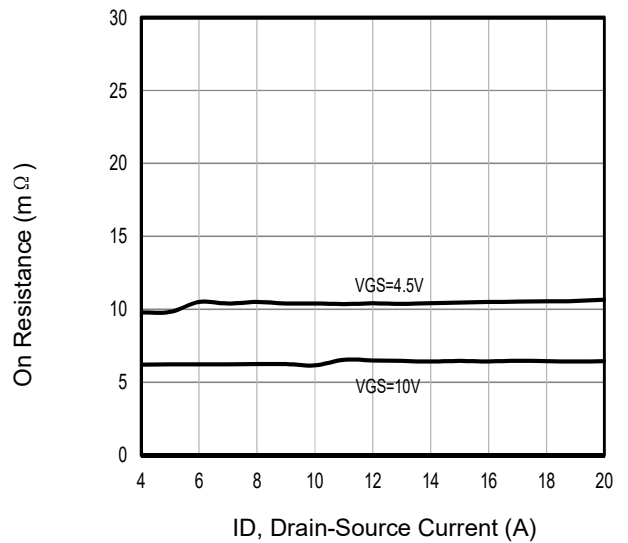

Fig6. On Resistance Vs Drain Current and Gate Voltage

Typical Characteristics

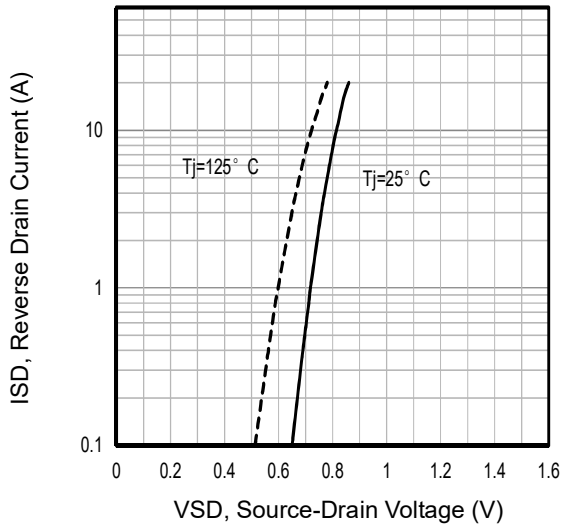

Fig7. Typical Source-Drain Diode Forward Voltage

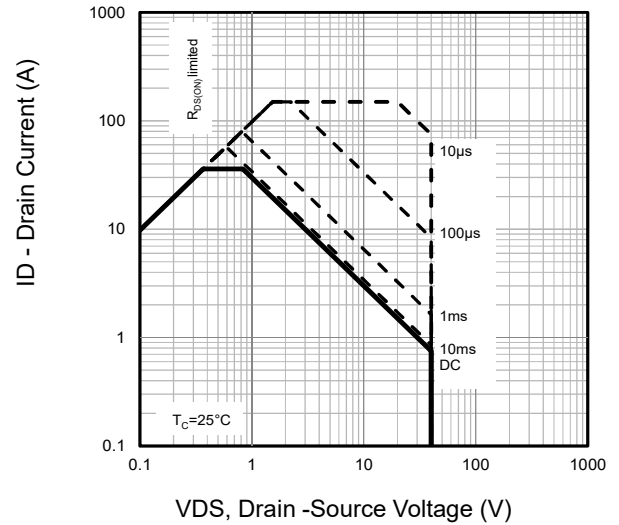

Fig8. Maximum Safe Operating Area

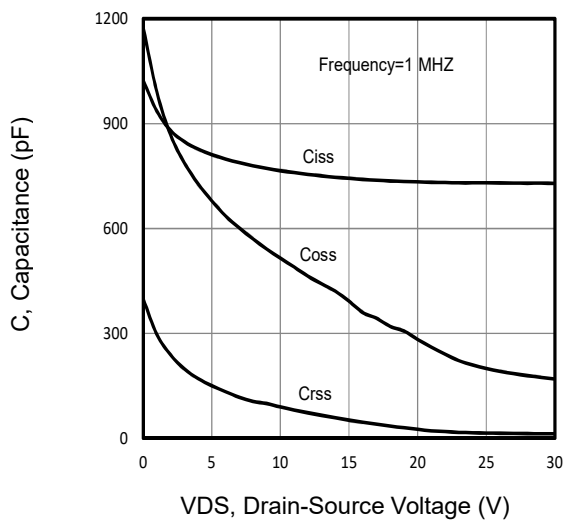

Fig9. Typical Capacitance Vs. Drain-Source Voltage

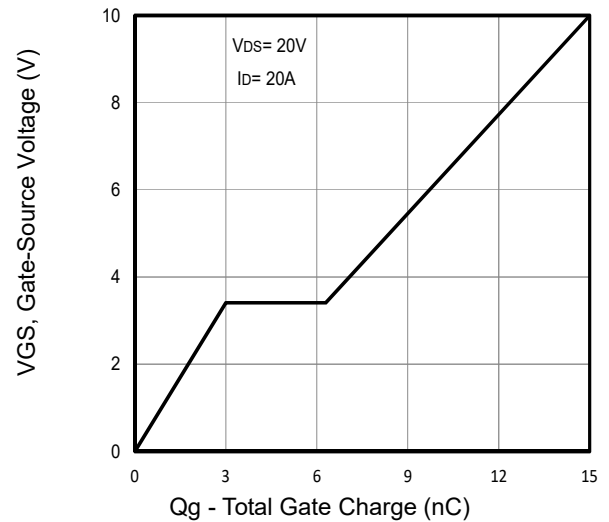

Fig10. Typical Gate Charge Vs. Gate-Source Voltage

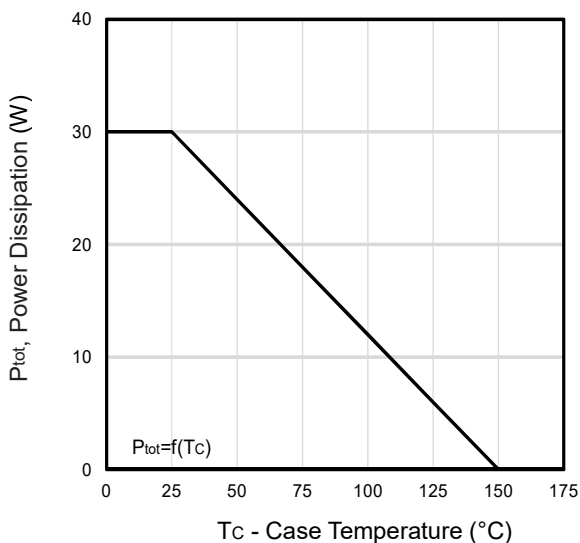

Fig11. Power Dissipation Vs. Case Temperature

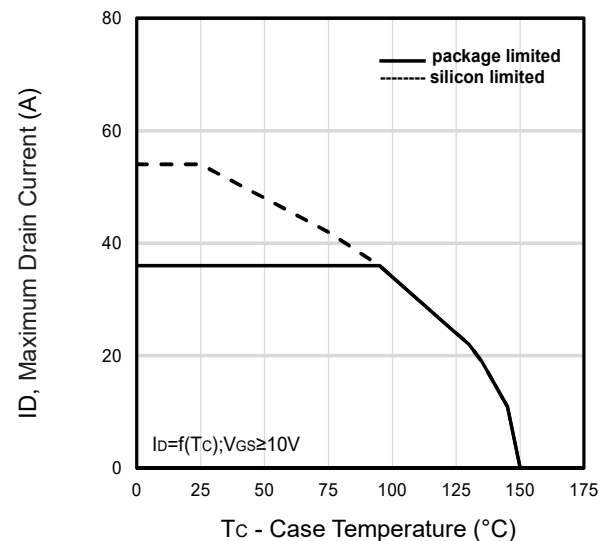

Fig12. Maximum Drain Current Vs. Case Temperature

Typical Characteristics

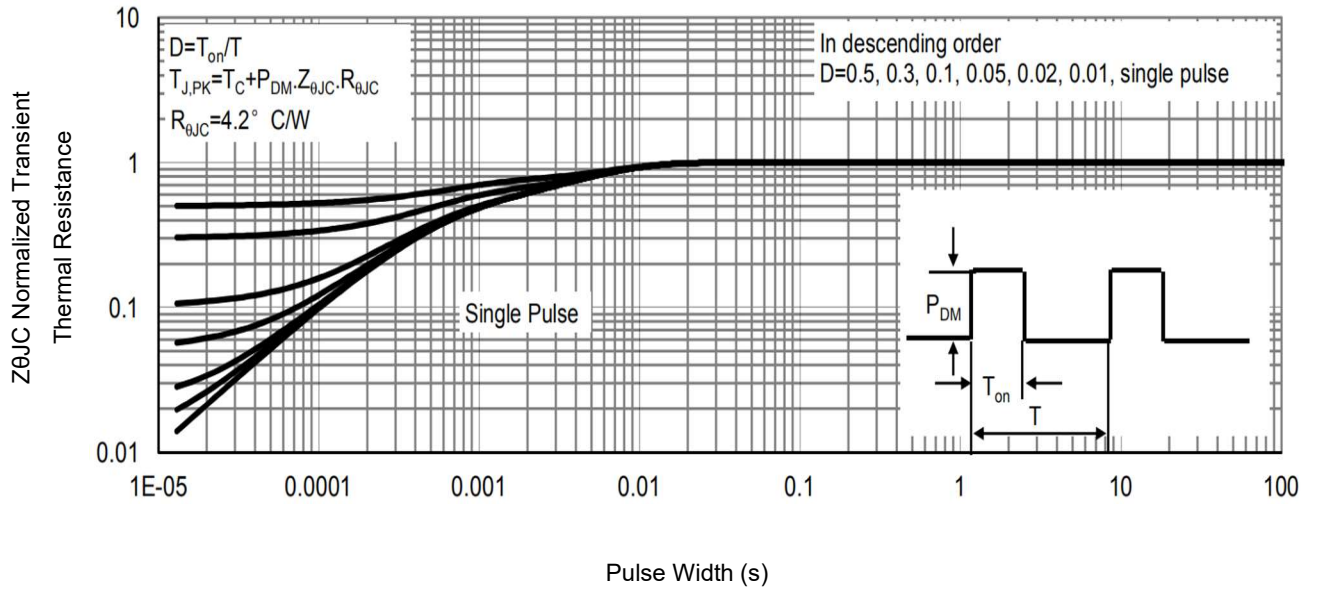

Fig13 . Normalized Maximum Transient Thermal Impedance

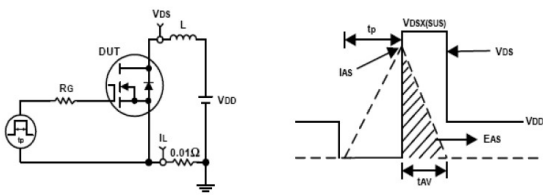

Fig14. Unclamped Inductive Test Circuit and waveforms

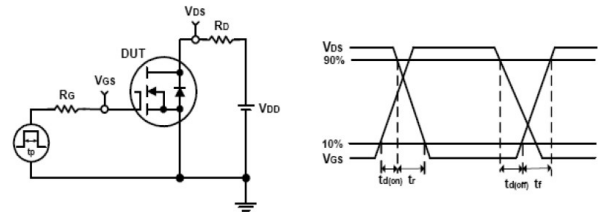
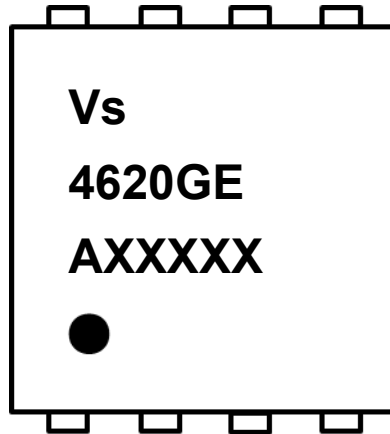

Fig15. Switching Time Test Circuit and waveforms

Marking Information



- 1st line: Vergiga Code (Vs)
2nd line: Part Number (4620GE)
3rd line: Date code (AXXXXX)
A: Manufacturer Factory Code
XXXXX: Wafer Lot Tracibility Code

PDFN3333 Package Outline Data

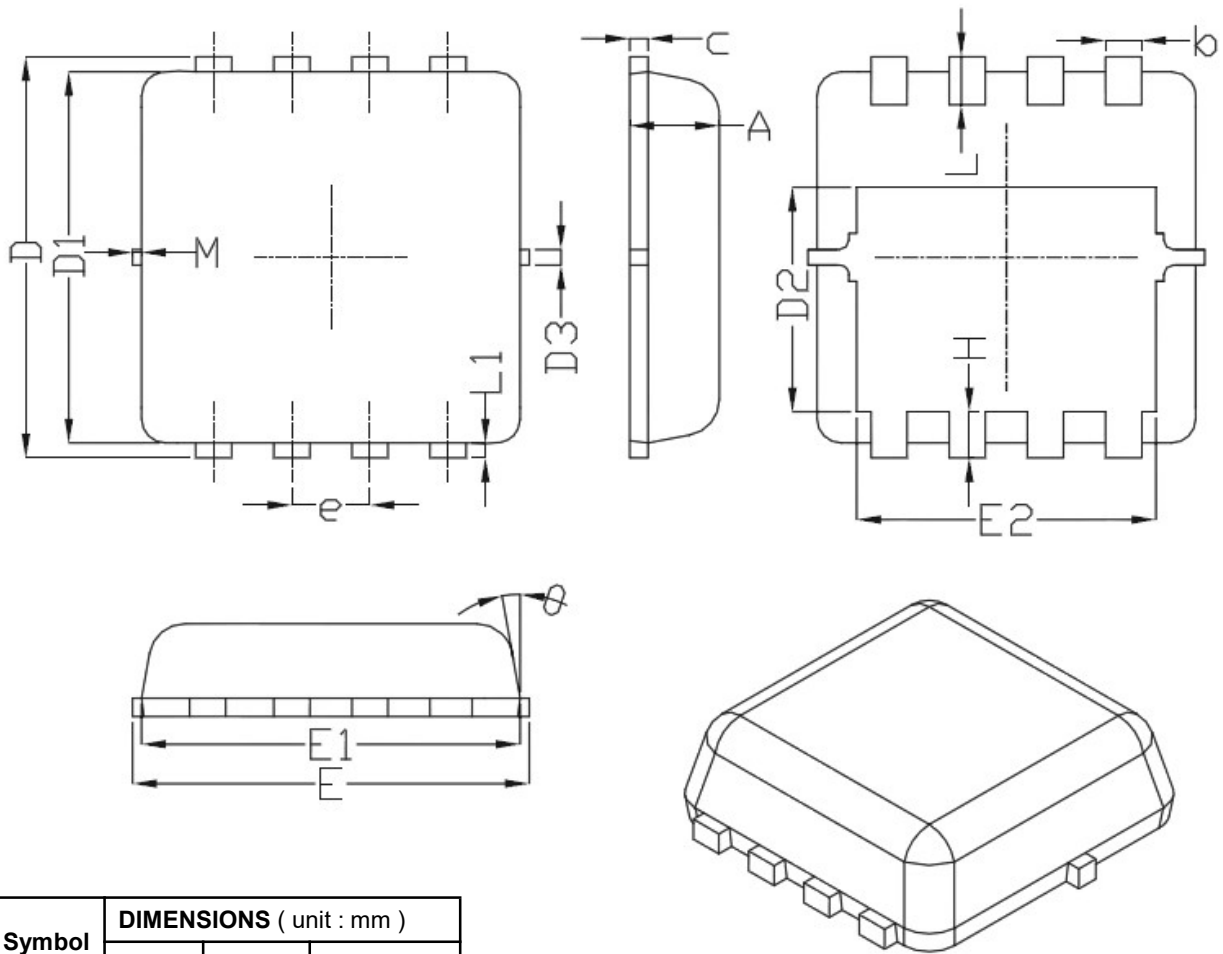

Symbol	DIMENSIONS (unit : mm)		
	Min	Typ	Max
A	0.7	0.75	0.8
b	0.25	0.3	0.35
C	0.1	0.15	0.25
D	3.25	3.35	3.45
D1	3	3.1	3.2
D2	1.78	1.88	1.98
D3	--	0.13	--
E	3.2	3.3	3.4
E1	3	3.15	3.2
E2	2.39	2.49	2.59
e	0.65 BSC		
H	0.3	0.39	0.5
L	0.3	0.4	0.5
L1	--	0.13	--
θ	--	10°	12°
M	*	*	0.15
* Not specified			

Notes:

1. Follow JEDEC MO-240 variation CA.
2. Dimensions "D1" and "E1" do NOT include mold flash protrusions or gate burrs.
3. Dimensions "D1" and "E1" include interterminal flash or protrusion. Interterminal flash or protrusion shall not exceed 0.25mm per side.

Customer Service

Sales and Service:

sales@vgsemi.com

Vergiga Semiconductor CO., LTD

TEL: (86-755) -26902410

FAX: (86-755) -26907027

WEB: www.vgsemi.com

X-ON Electronics

Largest Supplier of Electrical and Electronic Components

Click to view similar products for [MOSFET](#) category:

Click to view products by [Vanguard](#) manufacturer:

Other Similar products are found below :

[614233C](#) [648584F](#) [MCH3443-TL-E](#) [MCH6422-TL-E](#) [NTNS3A92PZT5G](#) [IRFD120](#) [IRFF430](#) [JANTX2N5237](#) [2N7000](#) [AOD464](#)
[2SK2267\(Q\)](#) [2SK2545\(Q,T\)](#) [405094E](#) [423220D](#) [MIC4420CM-TR](#) [VN1206L](#) [614234A](#) [715780A](#) [SSM6J414TU,LF\(T](#) [751625C](#)
[IPS70R2K0CEAKMA1](#) [BSF024N03LT3 G](#) [PSMN4R2-30MLD](#) [TK31J60W5,S1VQ\(O](#) [2SK2614\(TE16L1,Q\)](#) [DMN1017UCP3-7](#)
[EFC2J004NUZTDG](#) [FCAB21350L1](#) [P85W28HP2F-7071](#) [DMN1053UCP4-7](#) [NTE2384](#) [NTE2969](#) [NTE6400A](#) [DMC2700UDMQ-7](#)
[DMN2080UCB4-7](#) [DMN61D9UWQ-13](#) [US6M2GTR](#) [DMN31D5UDJ-7](#) [SSM6P54TU,LF](#) [DMP22D4UFO-7B](#) [IPS60R3K4CEAKMA1](#)
[DMN1006UCA6-7](#) [DMN16M9UCA6-7](#) [STF5N65M6](#) [IRF40H233XTMA1](#) [IPSA70R950CEAKMA1](#) [IPSA70R2K0CEAKMA1](#) [STU5N65M6](#)
[C3M0021120D](#) [DMN6022SSD-13](#)