

## Features

- Dual N-Channel, 5V Logic Level Control
- Enhancement mode
- Low on-resistance  $R_{DS(on)}$  @  $V_{GS}=4.5\text{ V}$
- VitoMOS<sup>®</sup> Technology
- Fast Switching and High efficiency
- Pb-free lead plating; RoHS compliant

$V_{DS}$	55	V
$R_{DS(on),TYP} @ V_{GS}=10\text{ V}$	16	m $\Omega$
$R_{DS(on),TYP} @ V_{GS}=4.5\text{ V}$	22	m $\Omega$
$I_D$	9	A



Part ID	Package Type	Marking	Tape and reel information
VS5814DS	SOP8	5814DS	3000pcs/reel

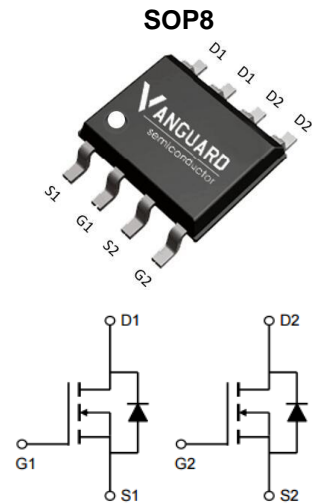

## Maximum ratings, at $T_A=25\text{ }^\circ\text{C}$ , unless otherwise specified

Symbol	Parameter	Rating	Unit
$V_{(BR)DSS}$	Drain-Source breakdown voltage	55	V
$V_{GS}$	Gate-Source voltage	$\pm 20$	V
$I_S$	Diode continuous forward current	$T_A=25\text{ }^\circ\text{C}$	1.7 A
$I_D$	Continuous drain current @ $V_{GS}=10\text{ V}$	$T_A=25\text{ }^\circ\text{C}$	9 A
		$T_A=100\text{ }^\circ\text{C}$	5.6 A
$I_{DM}$	Pulse drain current tested ①	$T_A=25\text{ }^\circ\text{C}$	36 A
EAS	Avalanche energy, single pulsed ②	31	mJ
$P_D$	Maximum power dissipation	$T_A=25\text{ }^\circ\text{C}$	2 W
$T_{STG}, T_J$	Storage and junction temperature range	-55 to 150	$^\circ\text{C}$

## Thermal Characteristics

Symbol	Parameter	Typical	Unit
$R_{\theta JL}$	Thermal Resistance, Junction-to-Lead	40	$^\circ\text{C/W}$
$R_{\theta JA}$	Thermal Resistance, Junction-to-Ambient	62.5	$^\circ\text{C/W}$

**Typical Electrical Characteristics**

Symbol	Parameter	Condition	Min.	Typ.	Max.	Unit
<b>Static Electrical Characteristics @ T<sub>J</sub> = 25°C (unless otherwise stated)</b>						
V <sub>(BR)DSS</sub>	Drain-Source Breakdown Voltage	V <sub>GS</sub> =0V, I <sub>D</sub> =250μA	55	--	--	V
I <sub>DSS</sub>	Zero Gate Voltage Drain Current(T <sub>J</sub> =25°C)	V <sub>DS</sub> =50V, V <sub>GS</sub> =0V	--	--	1	μA
	Zero Gate Voltage Drain Current(T <sub>J</sub> =125°C)	V <sub>DS</sub> =50V, V <sub>GS</sub> =0V	--	--	100	μA
I <sub>GSS</sub>	Gate-Body Leakage Current	V <sub>GS</sub> =±20V, V <sub>DS</sub> =0V	--	--	±100	nA
V <sub>GS(TH)</sub>	Gate Threshold Voltage	V <sub>DS</sub> =V <sub>GS</sub> , I <sub>D</sub> =250μA	1.3	1.9	2.4	V
R <sub>DS(ON)</sub>	Drain-Source On-State Resistance ③	V <sub>GS</sub> =10V, I <sub>D</sub> =8A	--	16	21	mΩ
R <sub>DS(ON)</sub>	Drain-Source On-State Resistance ③	V <sub>GS</sub> =4.5V, I <sub>D</sub> =6A	--	22	29	mΩ
<b>Dynamic Electrical Characteristics @ T<sub>J</sub> = 25°C (unless otherwise stated)</b>						
C <sub>iss</sub>	Input Capacitance	V <sub>DS</sub> =25V, V <sub>GS</sub> =0V, f=1MHz	1000	1250	1500	pF
C <sub>oss</sub>	Output Capacitance		40	95	150	pF
C <sub>rss</sub>	Reverse Transfer Capacitance		30	60	90	pF
R <sub>g</sub>	Gate Resistance	f=1MHz	--	4.3	--	Ω
Q <sub>g</sub>	Total Gate Charge	V <sub>DS</sub> =25V, I <sub>D</sub> =8A, V <sub>GS</sub> =10V	--	22	--	nC
Q <sub>gs</sub>	Gate-Source Charge		--	5.2	--	nC
Q <sub>gd</sub>	Gate-Drain Charge		--	5	--	nC
<b>Switching Characteristics</b>						
t <sub>d(on)</sub>	Turn-on Delay Time	V <sub>DD</sub> =25V, I <sub>D</sub> =8A, R <sub>G</sub> =3Ω, V <sub>GS</sub> =10V	--	8	--	ns
t <sub>r</sub>	Turn-on Rise Time		--	4.4	--	ns
t <sub>d(off)</sub>	Turn-Off Delay Time		--	25	--	ns
t <sub>f</sub>	Turn-Off Fall Time		--	6	--	ns
<b>Source- Drain Diode Characteristics @ T<sub>J</sub> = 25°C (unless otherwise stated)</b>						
V <sub>SD</sub>	Forward on voltage	I <sub>SD</sub> =8A, V <sub>GS</sub> =0V	--	0.8	1.2	V
t <sub>rr</sub>	Reverse Recovery Time	T <sub>J</sub> =25°C, I <sub>sd</sub> =8A, V <sub>GS</sub> =0V	--	9	--	ns
Q <sub>rr</sub>	Reverse Recovery Charge	di/dt=500A/μs	--	8.5	--	nC

NOTE:

- ① Repetitive rating; pulse width limited by max. junction temperature.
- ② Limited by T<sub>Jmax</sub>, starting T<sub>J</sub> = 25°C, L = 0.5mH, R<sub>G</sub> = 25Ω, I<sub>AS</sub> = 9A, V<sub>GS</sub> = 10V. Part not recommended for use above this value
- ③ Pulse width ≤ 300μs; duty cycles ≤ 2%.

Typical Characteristics

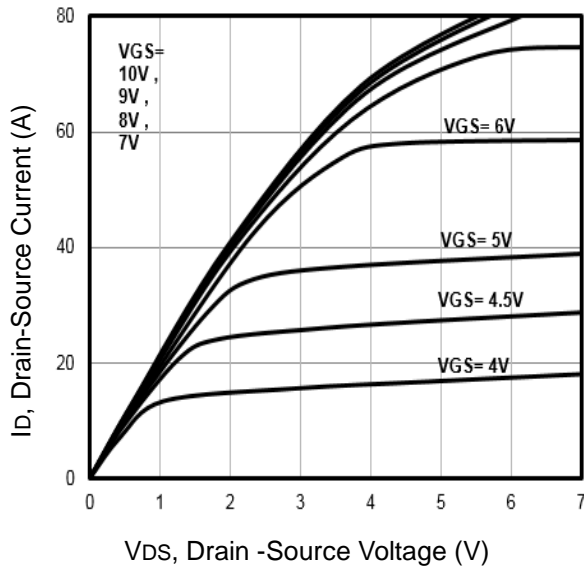

Fig1. Typical Output Characteristics

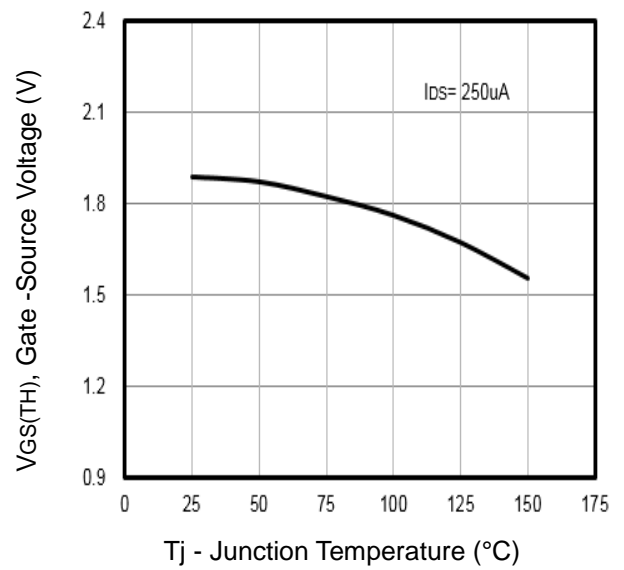

Fig2. Threshold Voltage Vs. Temperature

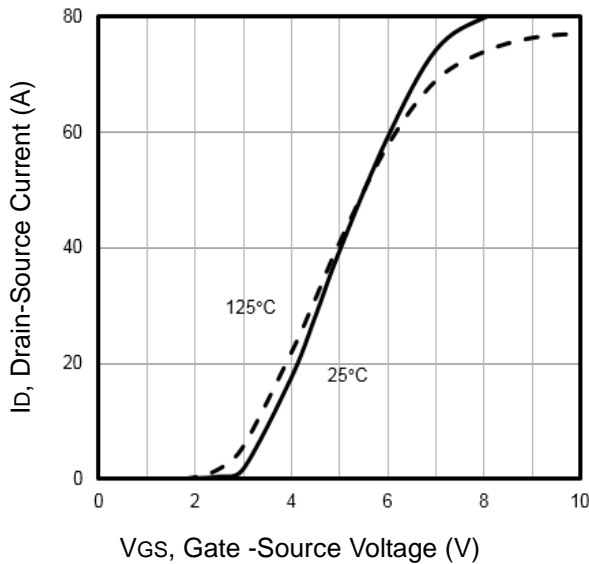

Fig3. Typical Transfer Characteristics

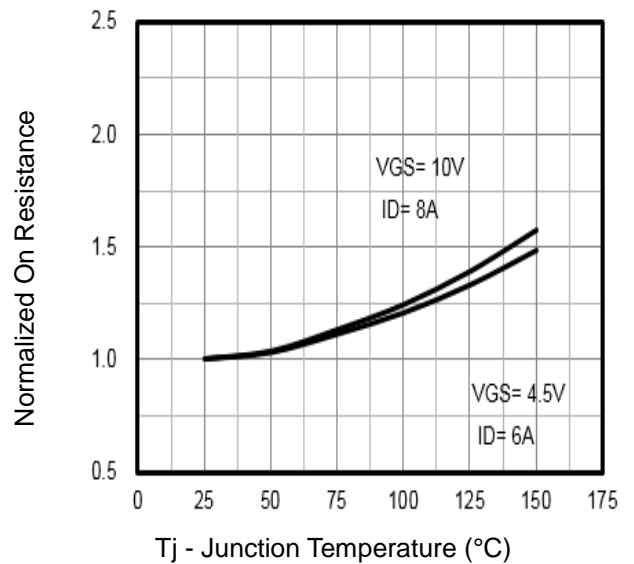

Fig4. Normalized On-Resistance Vs. Temperature

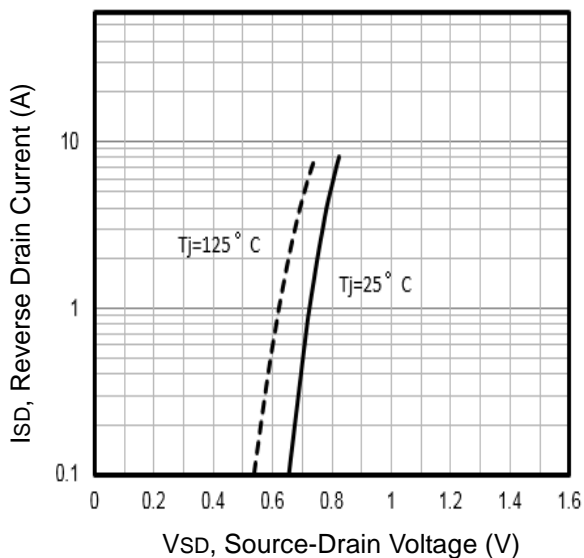

Fig5. Typical Source-Drain Diode Forward Voltage

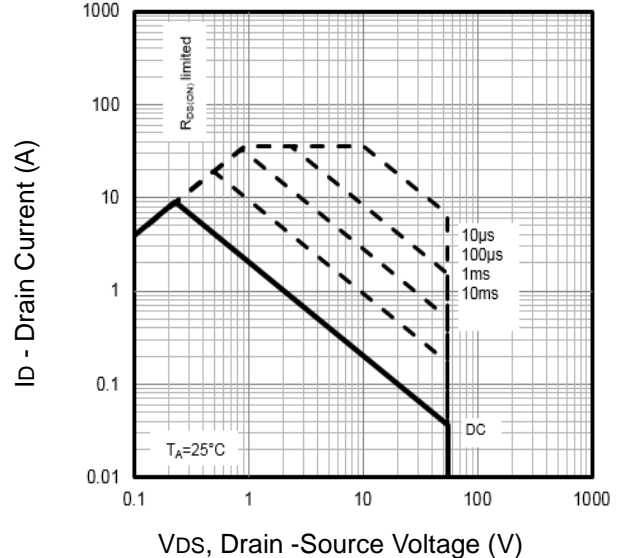

Fig6. Maximum Safe Operating Area

Typical Characteristics

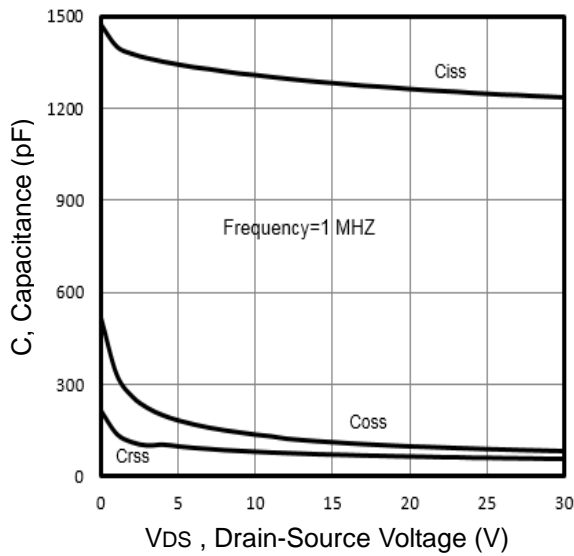

Fig7. Typical Capacitance Vs.Drain-Source Voltage

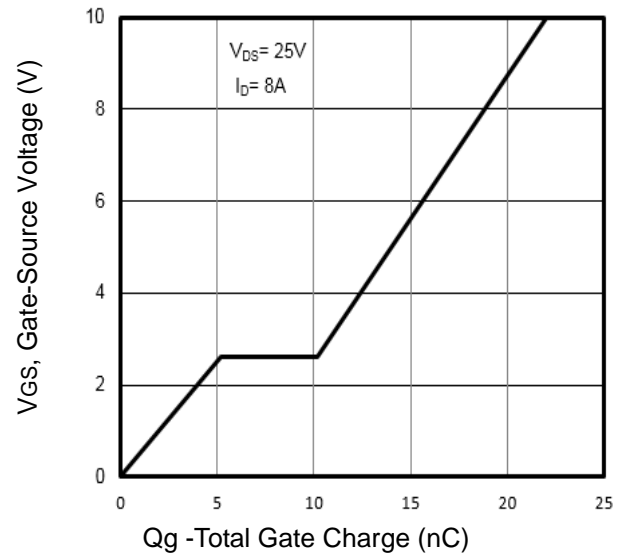

Fig8. Typical Gate Charge Vs.Gate-Source Voltage

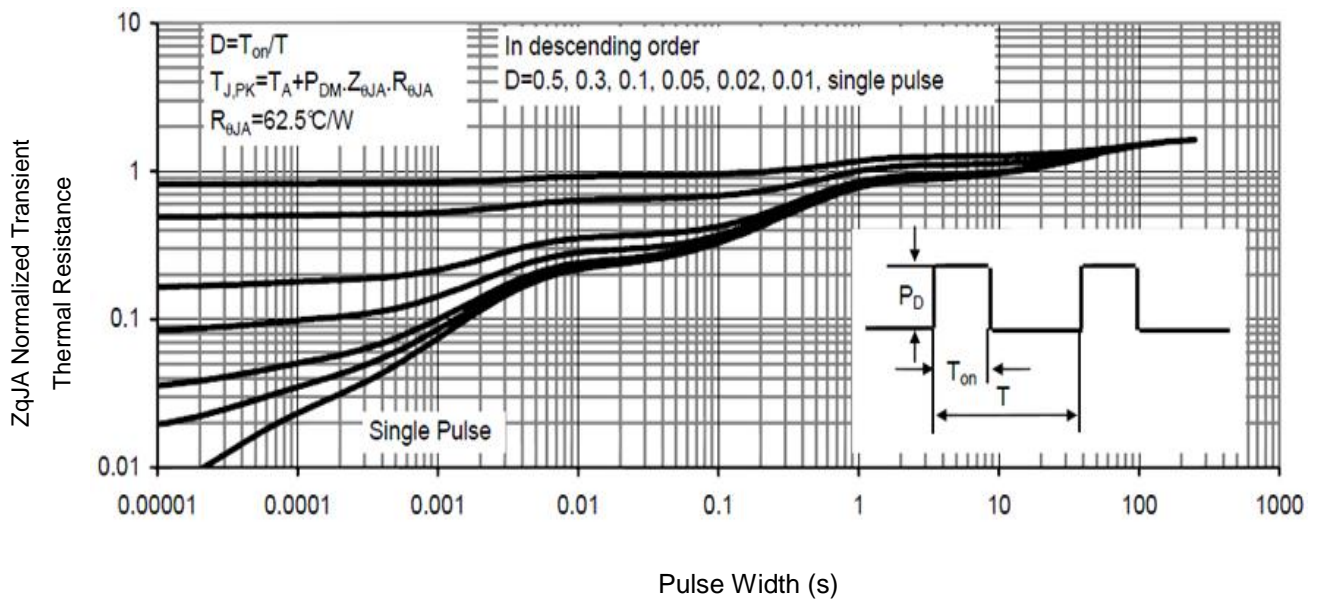

Fig9. Normalized Maximum Transient Thermal Impedance

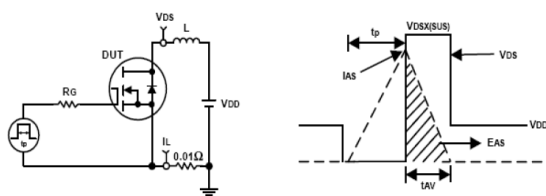

Fig10. Unclamped Inductive Test Circuit and waveforms

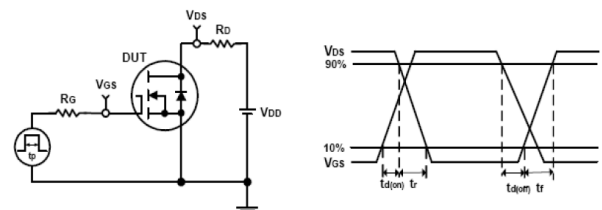
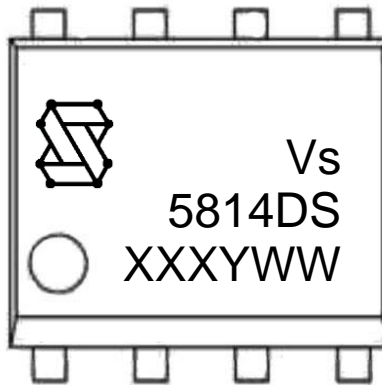

Fig11. Switching Time Test Circuit and waveforms

## Marking Information



1<sup>st</sup> line: Vanguard Code (Vs), Vanguard Logo

2<sup>nd</sup> line: Part Number (5814DS)

3<sup>rd</sup> line: Date code (XXXYWW)

XXX: Wafer Lot Number

Y: Year Code, e.g. E means 2017

WW: Week Code

### SOP8 Package Outline Data

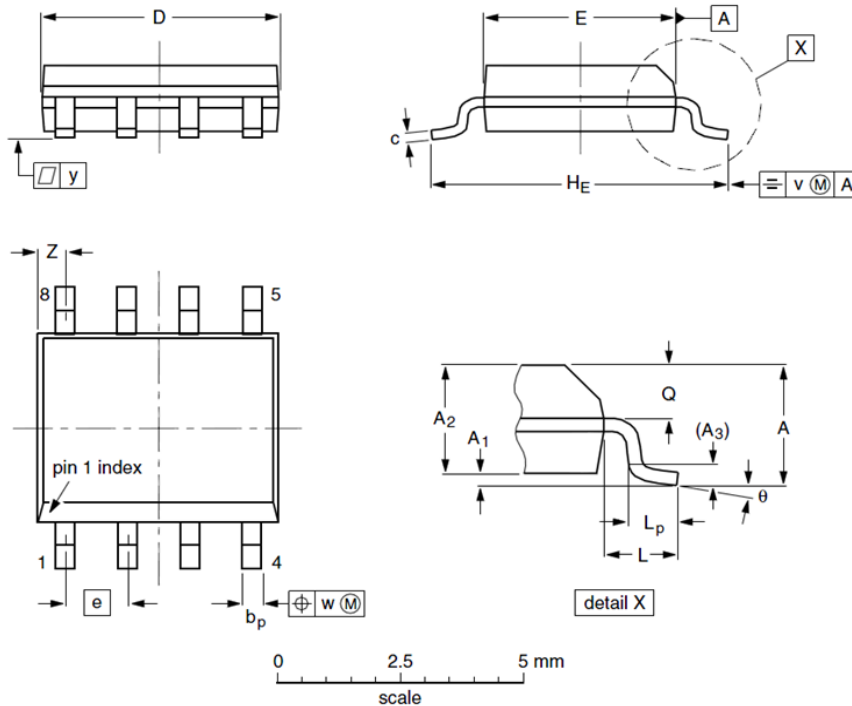

Label	Dimensions (unit: mm)		
	Min	Typ	Max
A	--	--	1.75
A <sub>1</sub>	0.10	0.18	0.25
A <sub>2</sub>	1.25	1.35	1.50
A <sub>3</sub>	--	0.25	--
b <sub>p</sub>	0.36	0.42	0.51
c	0.19	0.22	0.25
D	4.80	4.92	5.00
E	3.80	3.90	4.00
e	--	1.27	--
H <sub>E</sub>	5.80	6.00	6.20
L	--	1.05	--
L <sub>p</sub>	0.40	0.68	1.00
Q	0.60	0.65	0.725
v	--	0.25	--
w	--	0.25	--
y	--	0.10	--
Z	0.30	0.50	0.70
θ	0°		8°

#### Notes:

1. Follow JEDEC MS-012.
2. Dimension "D" does NOT include mold flash, protrusions or gate burrs. Mold flash, protrusions or gate burrs shall not exceed 0.15mm per side.
3. Dimension "E" does NOT include interlead flash or protrusion. Interlead flash or protrusion shall not exceed 0.25mm per side.
4. Dimension "b<sub>p</sub>" does NOT include dambar protrusion. Allowable dambar protrusion shall be 0.1mm total in excess of "b<sub>p</sub>" dimension at maximum material condition. The dambar cannot be located on the lower radius of the foot.

### Customer Service

#### Sales and Service:

[sales@vgsemi.com](mailto:sales@vgsemi.com)

**Vanguard Semiconductor CO., LTD**

**TEL:** (86-755) -26902410

**FAX:** (86-755) -26907027

**WEB:** [www.vgsemi.com](http://www.vgsemi.com)

## X-ON Electronics

Largest Supplier of Electrical and Electronic Components

*Click to view similar products for [MOSFET](#) category:*

*Click to view products by [Vanguard](#) manufacturer:*

Other Similar products are found below :

[614233C](#) [648584F](#) [MCH3443-TL-E](#) [MCH6422-TL-E](#) [FDPF9N50NZ](#) [FW216A-TL-2W](#) [FW231A-TL-E](#) [APT5010JVR](#) [NTNS3A92PZT5G](#)  
[IRF100S201](#) [JANTX2N5237](#) [2SK2464-TL-E](#) [2SK3818-DL-E](#) [FCA20N60\\_F109](#) [FDZ595PZ](#) [STD6600NT4G](#) [FSS804-TL-E](#) [2SJ277-DL-E](#)  
[2SK1691-DL-E](#) [2SK2545\(Q,T\)](#) [D2294UK](#) [405094E](#) [423220D](#) [MCH6646-TL-E](#) [TPCC8103,L1Q\(CM](#) [367-8430-0972-503](#) [VN1206L](#)  
[424134F](#) [026935X](#) [051075F](#) [SBVS138LT1G](#) [614234A](#) [715780A](#) [NTNS3166NZT5G](#) [751625C](#) [873612G](#) [IRF7380TRHR](#)  
[IPS70R2K0CEAKMA1](#) [RJK60S3DPP-E0#T2](#) [RJK60S5DPK-M0#T0](#) [APT5010JVFR](#) [APT12031JFLL](#) [APT12040JVR](#) [DMN3404LQ-7](#)  
[NTE6400](#) [JANTX2N6796U](#) [JANTX2N6784U](#) [JANTXV2N5416U4](#) [SQM110N05-06L-GE3](#) [SIHF35N60E-GE3](#)