

Features

- Enhancement mode
- Low on-resistance $R_{DS(on)}$ @ $V_{GS}=4.5\text{ V}$
- VitoMOS[®] II Technology
- 100% Avalanche test
- Pb-free lead plating; RoHS compliant



V_{DS}	65	V
$R_{DS(on),TYP}@ V_{GS}=10\text{V}$	10.5	m Ω
$R_{DS(on),TYP}@ V_{GS}=4.5\text{V}$	17	m Ω
I_D	40	A

PDFN3333

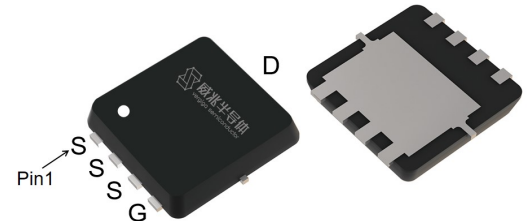

Part ID	Package Type	Marking	Packing
VS6614GE	PDFN3333	6614GE	5000pcs/Reel

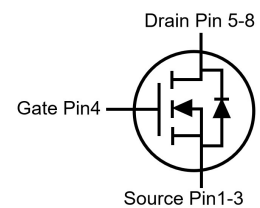

Maximum ratings, at $T_A=25\text{ }^\circ\text{C}$, unless otherwise specified

Symbol	Parameter	Rating	Unit
$V_{(BR)DSS}$	Drain-Source breakdown voltage	65	V
V_{GS}	Gate-Source voltage	± 20	V
I_S	Diode continuous forward current	$T_C=25\text{ }^\circ\text{C}$	40 A
I_D	Continuous drain current @ $V_{GS}=10\text{V}$	$T_C=25\text{ }^\circ\text{C}$	40 A
		$T_C=100\text{ }^\circ\text{C}$	25 A
I_{DM}	Pulse drain current tested ①	$T_C=25\text{ }^\circ\text{C}$	160 A
I_{DSM}	Continuous drain current @ $V_{GS}=10\text{V}$	$T_A=25\text{ }^\circ\text{C}$	14 A
		$T_A=70\text{ }^\circ\text{C}$	11 A
EAS	Avalanche energy, single pulsed ②	16	mJ
P_D	Maximum power dissipation	$T_C=25\text{ }^\circ\text{C}$	31 W
		$T_C=100\text{ }^\circ\text{C}$	13 W
P_{DSM}	Maximum power dissipation ③	$T_A=25\text{ }^\circ\text{C}$	3.6 W
		$T_A=70\text{ }^\circ\text{C}$	2.3 W
T_{STG}, T_J	Storage and junction temperature range	-55 to 150	$^\circ\text{C}$

Thermal Characteristics

Symbol	Parameter	Typical	Unit
$R_{\theta JC}$	Thermal Resistance, Junction-to-Case	4	$^\circ\text{C/W}$
$R_{\theta JA}$	Thermal Resistance, Junction-to-Ambient	35	$^\circ\text{C/W}$

Electrical Characteristics

Symbol	Parameter	Condition	Min.	Typ.	Max.	Unit
Static Electrical Characteristics @ T_j = 25°C (unless otherwise stated)						
V _{(BR)DSS}	Drain-Source Breakdown Voltage	V _{GS} =0V, I _D =250μA	65	--	--	V
I _{DSS}	Zero Gate Voltage Drain Current(T _J =25°C)	V _{DS} =60V, V _{GS} =0V	--	--	1	μA
	Zero Gate Voltage Drain Current(T _J =125°C)	V _{DS} =60V, V _{GS} =0V	--	--	100	μA
I _{GSS}	Gate-Body Leakage Current	V _{GS} =±20V, V _{DS} =0V	--	--	±100	nA
V _{GS(TH)}	Gate Threshold Voltage	V _{DS} =V _{GS} , I _D =250μA	1.5	1.8	2.5	V
R _{DS(ON)}	Drain-Source On-State Resistance ④	V _{GS} =10V, I _D =30A	--	10.5	15	mΩ
		T _J =100°C	--	13	--	mΩ
R _{DS(ON)}	Drain-Source On-State Resistance ④	V _{GS} =4.5V, I _D =10A	--	17	24	mΩ
Dynamic Electrical Characteristics @ T_J = 25°C (unless otherwise stated)						
C _{iss}	Input Capacitance	V _{DS} =30V, V _{GS} =0V, f=1MHz	660	780	900	pF
C _{oss}	Output Capacitance		320	375	430	pF
C _{rss}	Reverse Transfer Capacitance		--	10	20	pF
R _g	Gate Resistance	f=1MHz	--	1.4	--	Ω
Q _g (10V)	Total Gate Charge	V _{DS} =30V, I _D =30A, V _{GS} =10V	--	13	--	nC
Q _g (4.5V)	Total Gate Charge		--	6	--	nC
Q _{gs}	Gate-Source Charge		--	3.1	--	nC
Q _{gd}	Gate-Drain Charge		--	2	--	nC
Switching Characteristics						
t _{d(on)}	Turn-on Delay Time	V _{DD} =30V, I _D =30A, R _G =3Ω, V _{GS} =10V	--	6	--	ns
t _r	Turn-on Rise Time		--	44	--	ns
t _{d(off)}	Turn-Off Delay Time		--	12	--	ns
t _f	Turn-Off Fall Time		--	3.6	--	ns
Source- Drain Diode Characteristics@ T_J = 25°C (unless otherwise stated)						
V _{SD}	Forward on voltage	I _{SD} =30A, V _{GS} =0V	--	0.9	1.2	V
t _{rr}	Reverse Recovery Time	T _J =25°C, I _{sd} =30A, V _{GS} =0V	--	17	--	ns
Q _{rr}	Reverse Recovery Charge	di/dt=100A/μs	--	7.4	--	nC

NOTE:

- ① Repetitive rating; pulse width limited by max junction temperature.
- ② Limited by T_{Jmax}, starting T_J = 25°C, L = 0.5mH, R_G = 25Ω, I_{AS} = 8A, V_{GS} = 10V. Part not recommended for use above this value
- ③ The power dissipation P_{DSM} is based on R_{θJA} and the maximum allowed junction temperature of 150°C.
- ④ Pulse width ≤ 380μs; duty cycle ≤ 2%.

Typical Characteristics

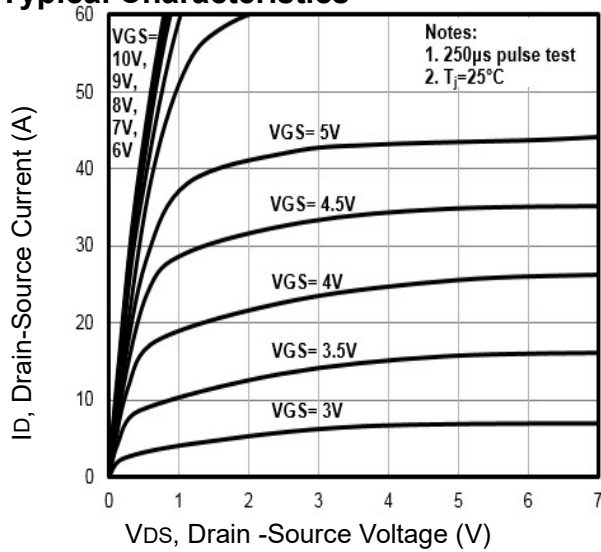

Fig1. Typical Output Characteristics

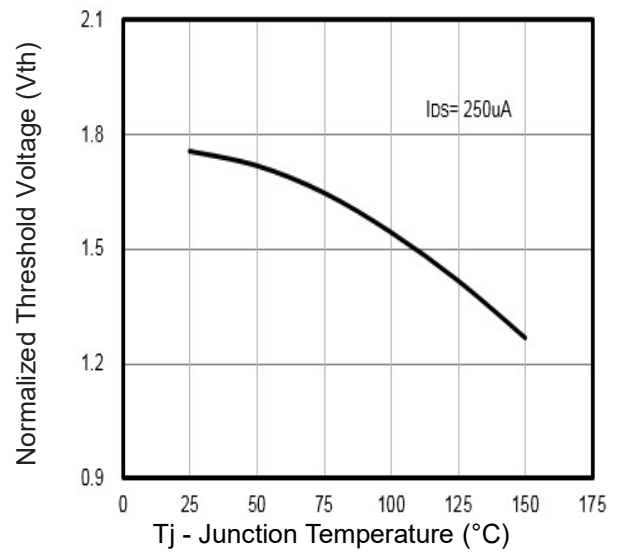

Fig2. Normalized Threshold Voltage Vs. Temperature

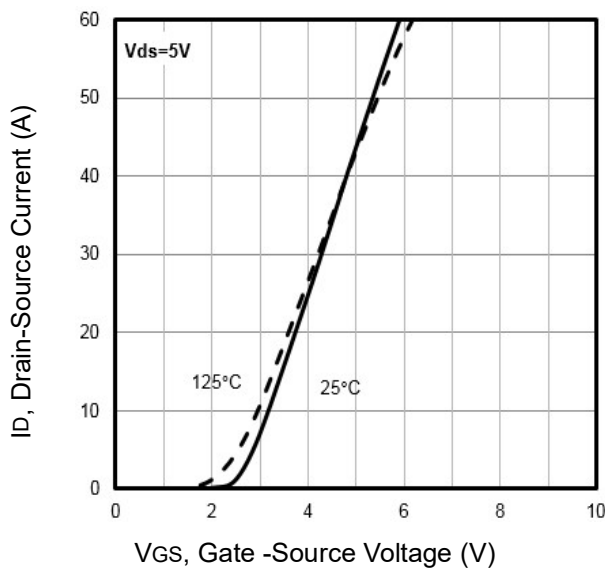

Fig3. Typical Transfer Characteristics

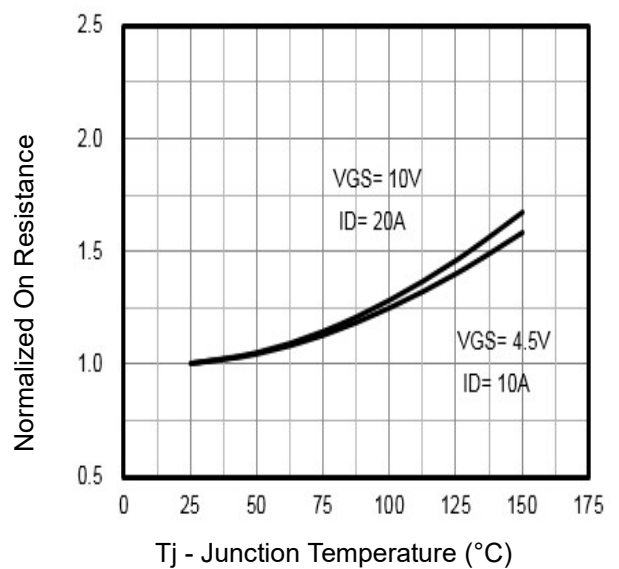

Fig4. Normalized On-Resistance Vs. Temperature

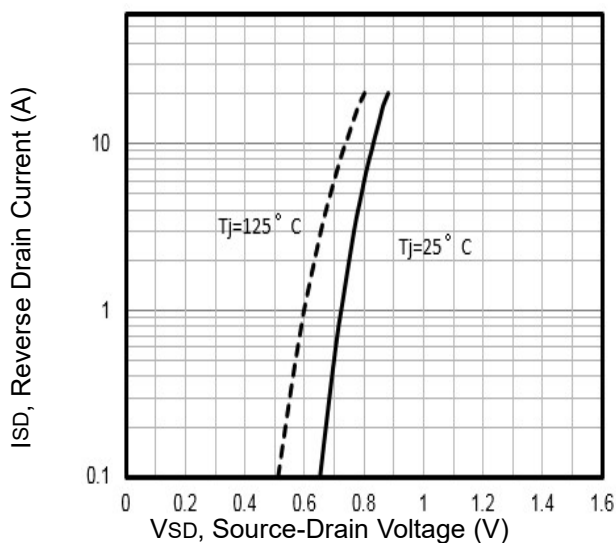

Fig5. Typical Source-Drain Diode Forward Voltage

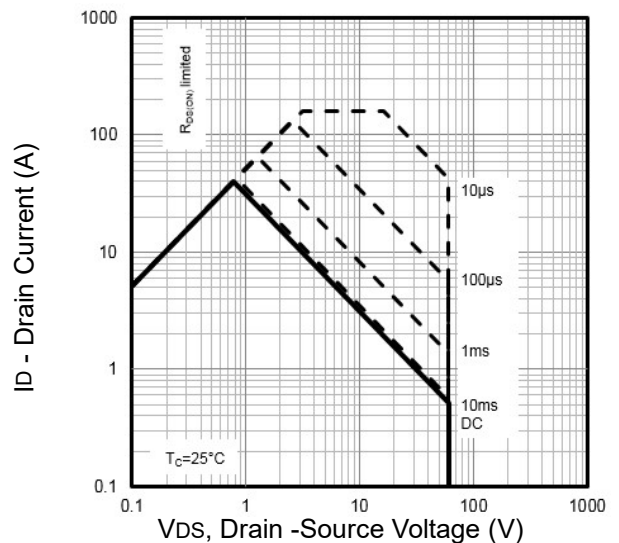

Fig6. Maximum Safe Operating Area

Typical Characteristics

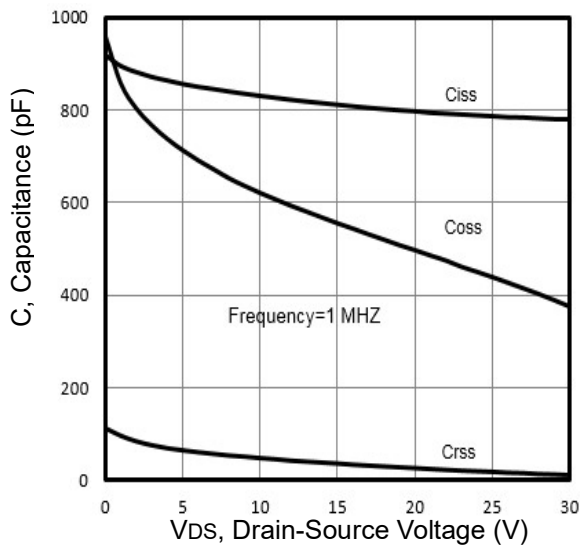

Fig7. Typical Capacitance Vs. Drain-Source Voltage

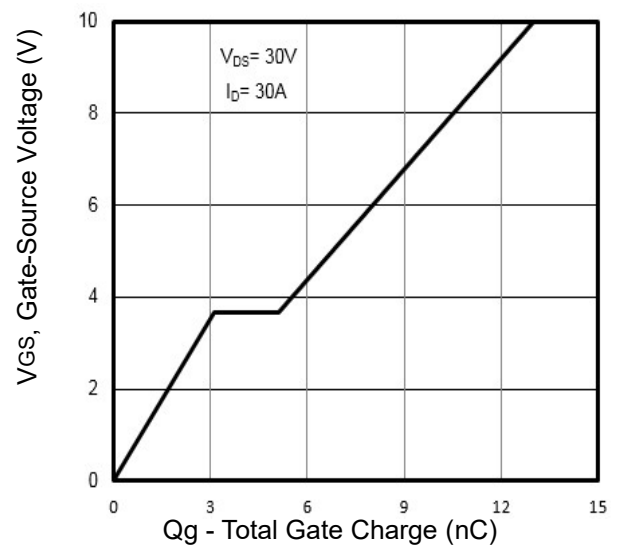

Fig8. Typical Gate Charge Vs. Gate-Source

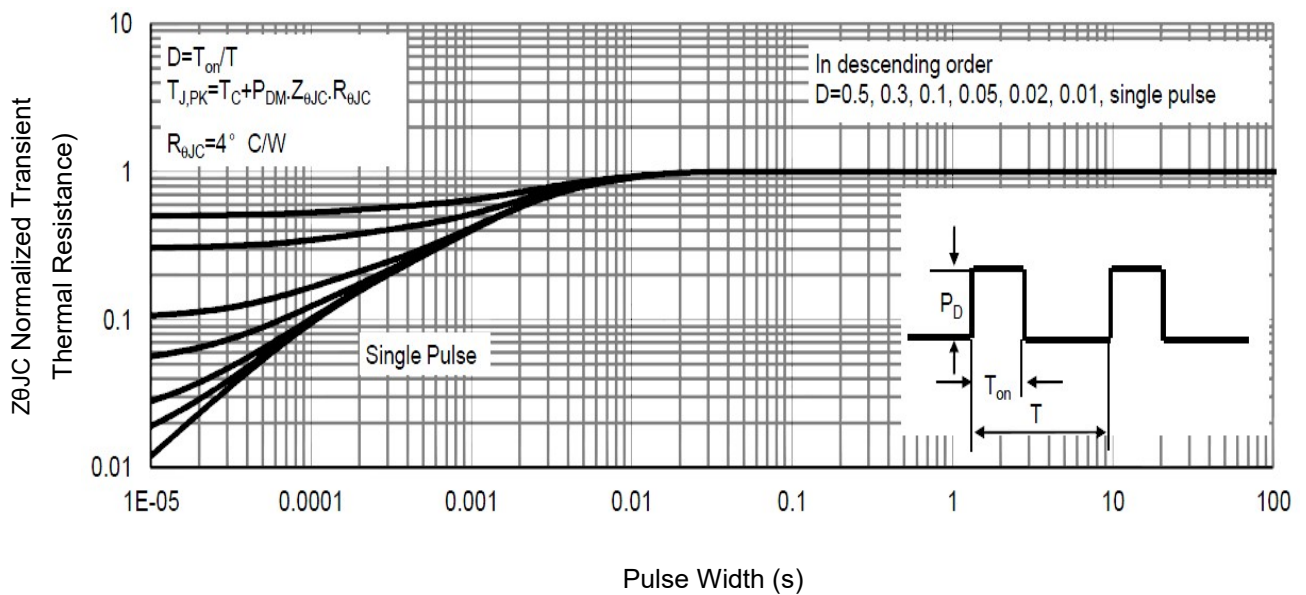

Fig9. Normalized Maximum Transient Thermal Impedance

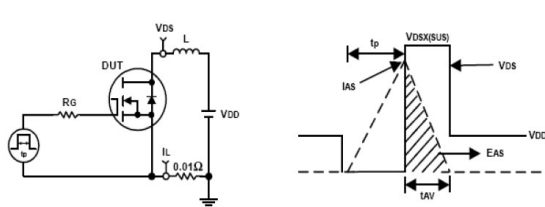

Fig10. Unclamped Inductive Test Circuit and waveforms

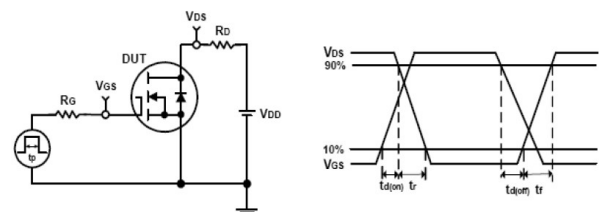
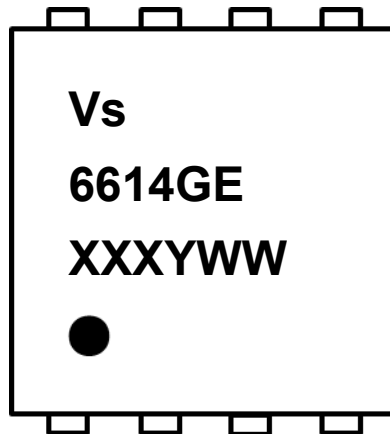

Fig11. Switching Time Test Circuit and waveforms

Marking Information

1st line: Vergiga Code (Vs)

2nd line: Part Number (6614GE)

3rd line: Date code (XXXYWW)

XXX: Wafer Lot Number Code , code changed with Lot Number

Y: Year Code , refer to table below

WW: Week Code (01 to 53)

Code	C	D	E	F	G	H	J	K	L	M	N	P	Q	R	S	T
Year	2015	2016	2017	2018	2019	2020	2021	2022	2023	2024	2025	2026	2027	2028	2029	2030

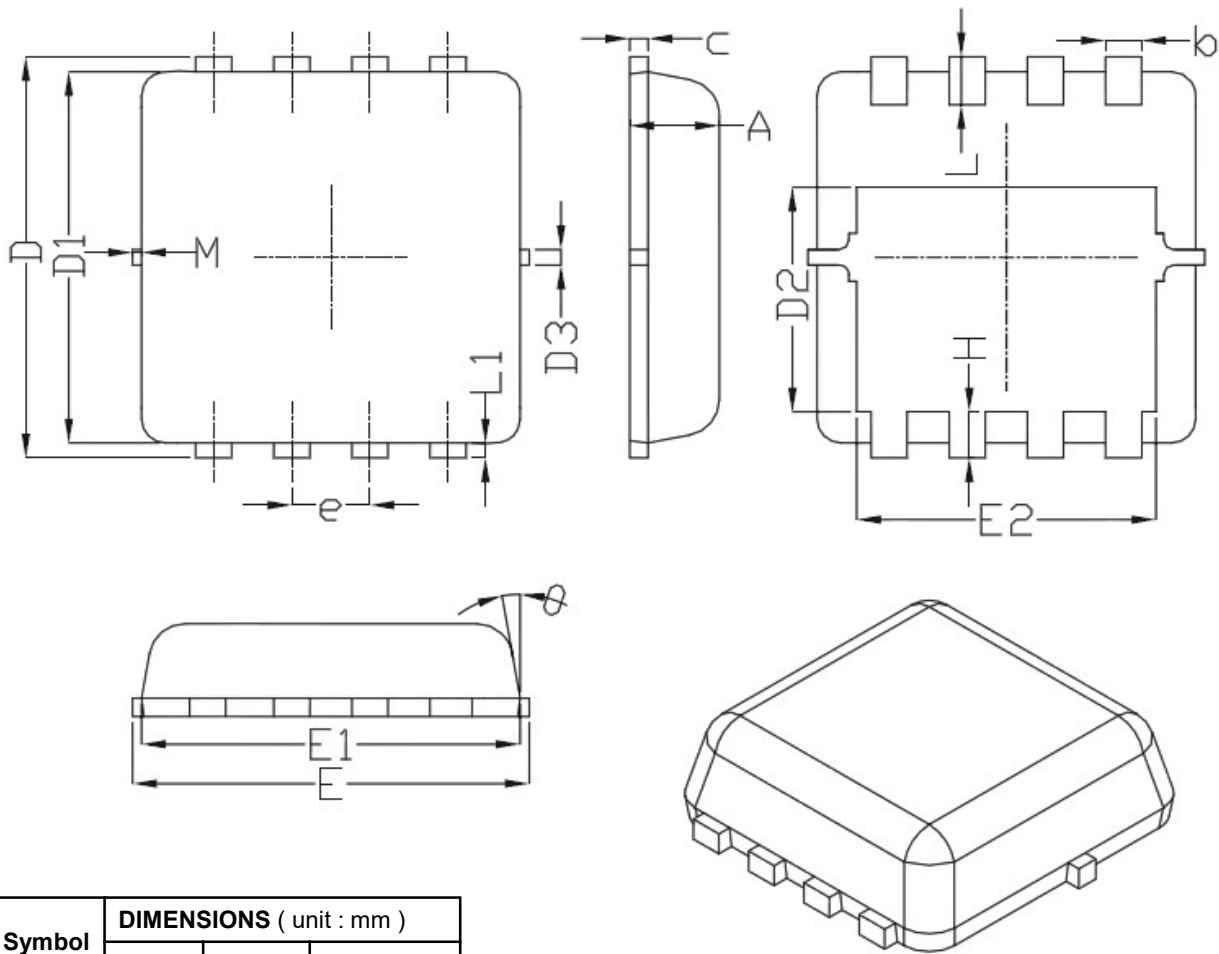
PDFN3333 Package Outline Data

Symbol	DIMENSIONS (unit : mm)		
	Min	Typ	Max
A	0.7	0.75	0.8
b	0.25	0.3	0.35
C	0.1	0.15	0.25
D	3.25	3.35	3.45
D1	3	3.1	3.2
D2	1.78	1.88	1.98
D3	--	0.13	--
E	3.2	3.3	3.4
E1	3	3.15	3.2
E2	2.39	2.49	2.59
e	0.65 BSC		
H	0.3	0.39	0.5
L	0.3	0.4	0.5
L1	--	0.13	--
θ	--	10°	12°
M	*	*	0.15

* Not specified

Notes:

1. Follow JEDEC MO-240 variation CA.
2. Dimensions "D1" and "E1" do NOT include mold flash protrusions or gate burrs.
3. Dimensions "D1" and "E1" include interterminal flash or protrusion. Interterminal flash or protrusion shall not exceed 0.25mm per side.

Customer Service
Sales and Service:

sales@vgsemi.com

Vergiga Semiconductor CO., LTD

TEL: (86-755) -26902410

FAX: (86-755) -26907027

WEB: www.vgsemi.com

X-ON Electronics

Largest Supplier of Electrical and Electronic Components

Click to view similar products for [MOSFET](#) category:

Click to view products by [Vanguard](#) manufacturer:

Other Similar products are found below :

[614233C](#) [648584F](#) [MCH3443-TL-E](#) [MCH6422-TL-E](#) [NTNS3A92PZT5G](#) [IRFD120](#) [IRFF430](#) [JANTX2N5237](#) [2N7000](#) [AOD464](#)
[2SK2267\(Q\)](#) [2SK2545\(Q,T\)](#) [405094E](#) [423220D](#) [MIC4420CM-TR](#) [VN1206L](#) [614234A](#) [715780A](#) [SSM6J414TU,LF\(T](#) [751625C](#)
[IPS70R2K0CEAKMA1](#) [BSF024N03LT3 G](#) [PSMN4R2-30MLD](#) [TK31J60W5,S1VQ\(O](#) [2SK2614\(TE16L1,Q\)](#) [DMN1017UCP3-7](#)
[EFC2J004NUZTDG](#) [FCAB21350L1](#) [P85W28HP2F-7071](#) [DMN1053UCP4-7](#) [NTE2384](#) [NTE2969](#) [NTE6400A](#) [DMC2700UDMQ-7](#)
[DMN2080UCB4-7](#) [DMN61D9UWQ-13](#) [US6M2GTR](#) [DMN31D5UDJ-7](#) [SSM6P54TU,LF](#) [DMP22D4UFO-7B](#) [IPS60R3K4CEAKMA1](#)
[DMN1006UCA6-7](#) [DMN16M9UCA6-7](#) [STF5N65M6](#) [IRF40H233XTMA1](#) [IPSA70R950CEAKMA1](#) [IPSA70R2K0CEAKMA1](#) [STU5N65M6](#)
[C3M0021120D](#) [DMN6022SSD-13](#)