

Features

- Enhancement mode
- Low on-resistance $R_{DS(on)}$ @ $V_{GS}=4.5\text{ V}$
- VitoMOS[®] II Technology
- 100% Avalanche test
- Pb-free lead plating; RoHS compliant

V_{DS}	60	V
$R_{DS(on),TYP}@ V_{GS}=10\text{ V}$	10.5	m Ω
$R_{DS(on),TYP}@ V_{GS}=4.5\text{ V}$	17	m Ω
I_D	13	A



Part ID	Package Type	Marking	Tape and reel information
VS6614GS	SOP8	6614GS	3000PCS/Reel

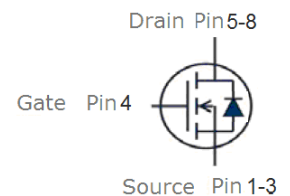

Maximum ratings, at $T_A=25^\circ\text{C}$, unless otherwise specified

Symbol	Parameter	Rating	Unit
$V_{(BR)DSS}$	Drain-Source breakdown voltage	60	V
V_{GS}	Gate-Source voltage	± 20	V
I_S	Diode continuous forward current	$T_A=25^\circ\text{C}$	2.6 A
I_D	Continuous drain current @ $V_{GS}=10\text{V}$	$T_A=25^\circ\text{C}$	13 A
		$T_A=70^\circ\text{C}$	10 A
I_{DM}	Pulse drain current tested ①	$T_A=25^\circ\text{C}$	52 A
EAS	Avalanche energy, single pulsed ②	16	mJ
P_D	Maximum power dissipation	$T_A=25^\circ\text{C}$	3.1 W
T_{STG}, T_J	Storage and junction temperature range	-55 to 150	$^\circ\text{C}$

Thermal Characteristics

Symbol	Parameter	Typical	Max	Unit
$R_{\theta JL}$	Thermal Resistance, Junction-to-Lead	24	29	$^\circ\text{C/W}$
$R_{\theta JA}$	Thermal Resistance, Junction-to-Ambient	40	48	$^\circ\text{C/W}$

Electrical Characteristics

Symbol	Parameter	Condition	Min.	Typ.	Max.	Unit
Static Electrical Characteristics @ T_j=25°C (unless otherwise stated)						
V _{(BR)DSS}	Drain-Source Breakdown Voltage	V _{GS} =0V, I _D =250μA	60	--	--	V
I _{DSS}	Zero Gate Voltage Drain Current(T _j =25°C)	V _{DS} =60V,V _{GS} =0V	--	--	1	uA
	Zero Gate Voltage Drain Current(T _j =125°C)	V _{DS} =60V,V _{GS} =0V	--	--	100	uA
I _{GSS}	Gate-Body Leakage Current	V _{GS} =±20V,V _{DS} =0V	--	--	±100	nA
V _{GS(TH)}	Gate Threshold Voltage	V _{DS} =V _{GS} ,I _D =250μA	1.55	1.8	2.5	V
R _{DS(ON)}	Drain-Source On-State Resistance ③	V _{GS} =10V, I _D =10A	--	10.5	13	mΩ
		T _j =100°C	--	15	--	mΩ
R _{DS(ON)}	Drain-Source On-State Resistance ③	V _{GS} =4.5V, I _D =8A	--	17	24	mΩ
Dynamic Electrical Characteristics @ T_j = 25°C (unless otherwise stated)						
C _{iss}	Input Capacitance	V _{DS} =30V,V _{GS} =0V, f=1MHz	660	780	900	pF
C _{oss}	Output Capacitance		320	375	430	pF
C _{rss}	Reverse Transfer Capacitance		1	10	20	pF
R _g	Gate Resistance	f=1MHz	0.7	1.3	1.9	Ω
Q _g (10V)	Total Gate Charge	V _{DS} =30V,I _D =10A, V _{GS} =10V	9	13	17	nC
Q _g (4.5V)	Total Gate Charge		4.4	6.3	8.2	nC
Q _{gs}	Gate-Source Charge		1.8	2.5	3.3	nC
Q _{gd}	Gate-Drain Charge		1.4	2	2.6	nC
Switching Characteristics						
t _{d(on)}	Turn-on Delay Time	V _{DD} =30V, I _D =10A, R _G =3.0Ω, V _{GS} =10V	--	6	--	ns
t _r	Turn-on Rise Time		--	15	--	ns
t _{d(off)}	Turn-Off Delay Time		--	13	--	ns
t _f	Turn-Off Fall Time		--	3.4	--	ns
Source- Drain Diode Characteristics@ T_j = 25°C (unless otherwise stated)						
V _{SD}	Forward on voltage	I _{SD} =10A,V _{GS} =0V	--	0.8	1.2	V
t _{rr}	Reverse Recovery Time	T _j =25°C,I _{sd} =10A, V _{GS} =0V	10	20	40	ns
Q _{rr}	Reverse Recovery Charge	di/dt=100A/μs	4	7.9	16	nC

NOTE:

- ① Repetitive rating; pulse width limited by max junction temperature.
- ② Limited by T_{Jmax}, starting T_J = 25°C, L = 0.5mH, R_G = 25Ω, I_{AS} = 8A, V_{GS} = 10V. Part not recommended for use above this value
- ③ Pulse width ≤ 380μs; duty cycle ≤ 2%.

Typical Characteristics

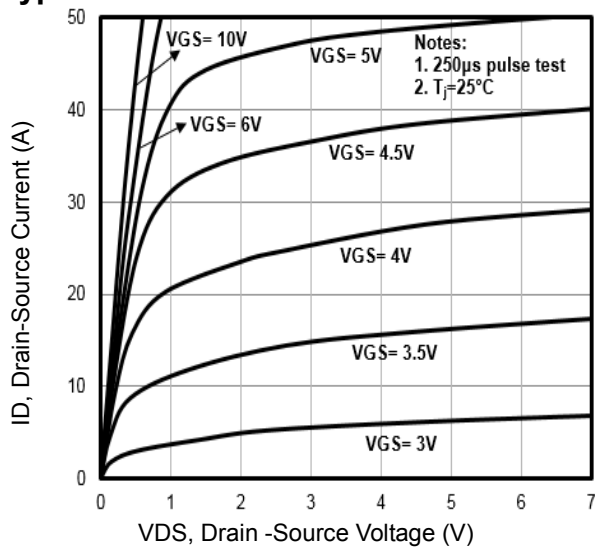

Fig1. Typical Output Characteristics

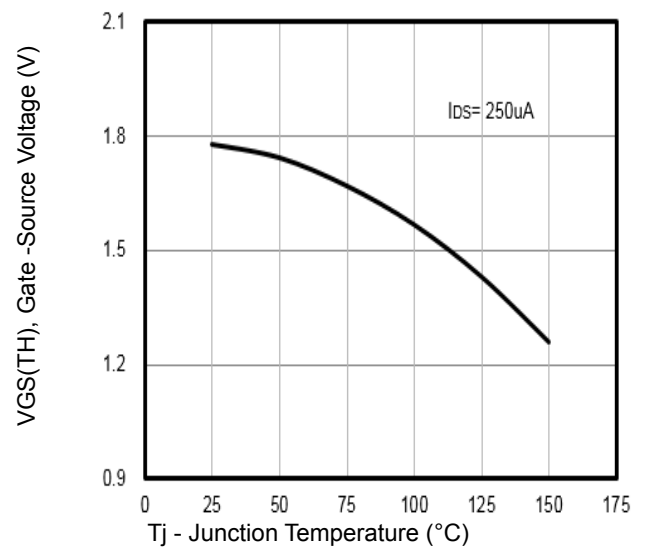

Fig2. $V_{GS(TH)}$ Gate-Source Voltage Vs. T_j

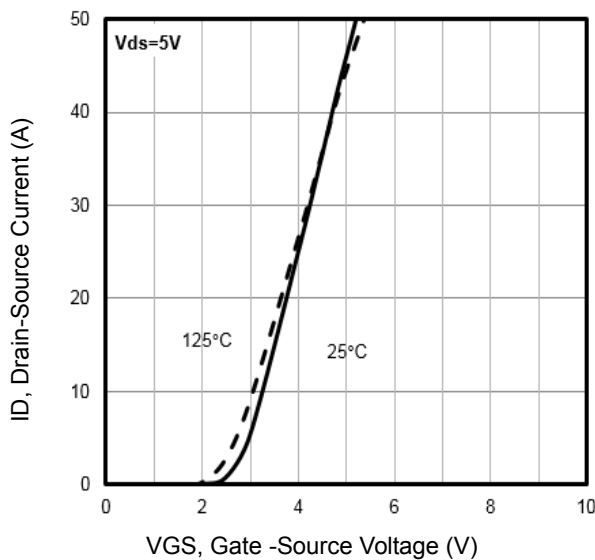

Fig3. Typical Transfer Characteristics

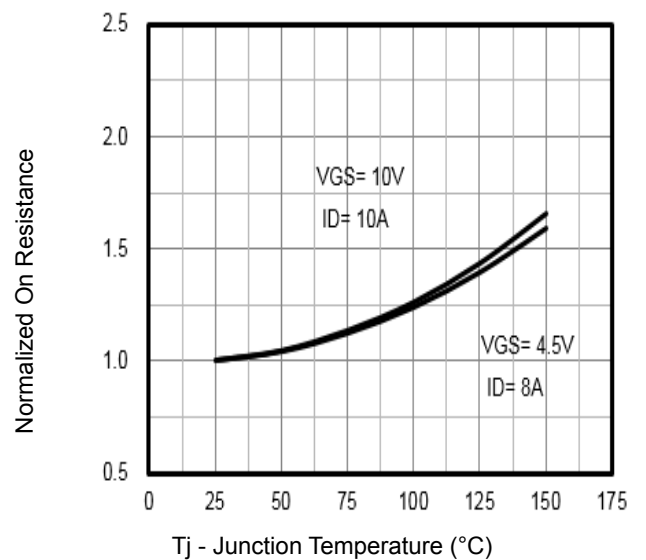

Fig4. Normalized On-Resistance Vs. T_j

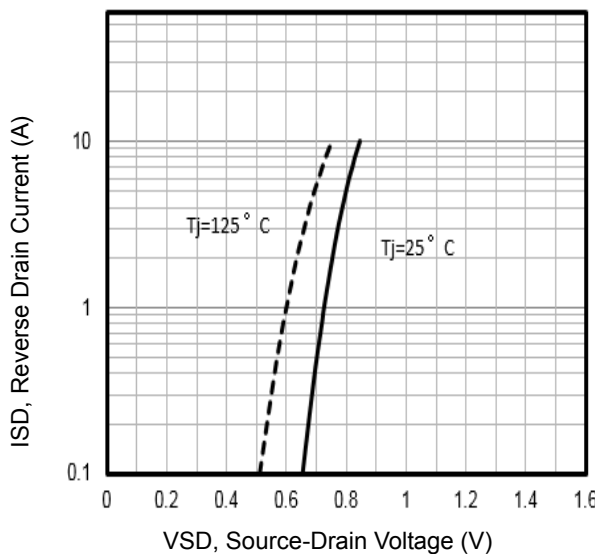

Fig5. Typical Source-Drain Diode Forward Voltage

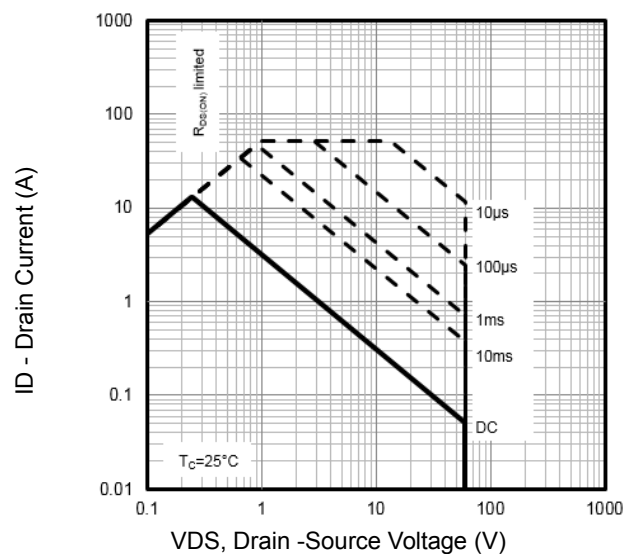

Fig6. Maximum Safe Operating Area

Typical Characteristics

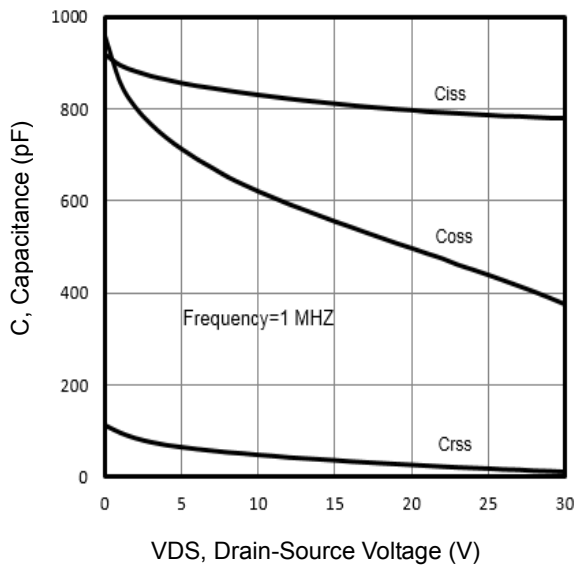

Fig7. Typical Capacitance Vs. Drain-Source Voltage

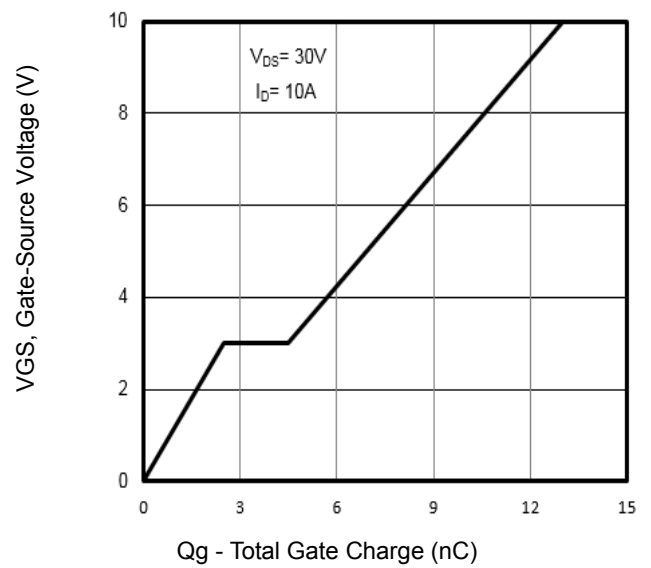

Fig8. Typical Gate Charge Vs. Gate-Source Voltage

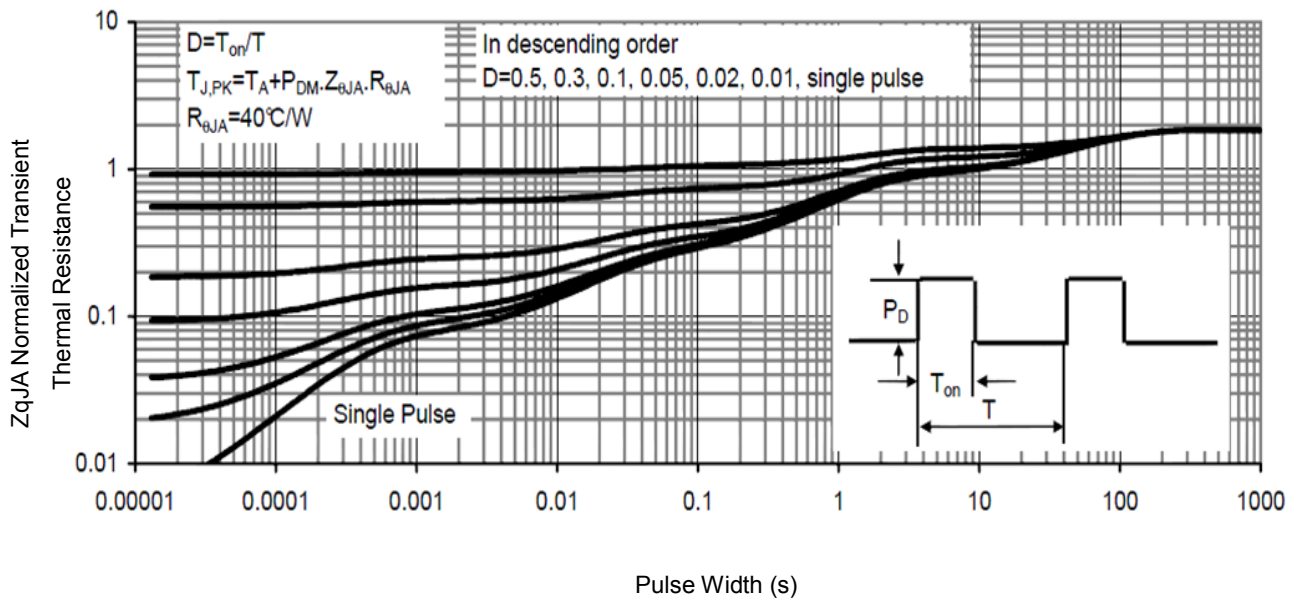

Fig9. Normalized Maximum Transient Thermal Impedance

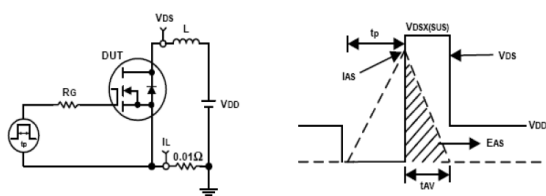

Fig10. Unclamped Inductive Test Circuit and waveforms

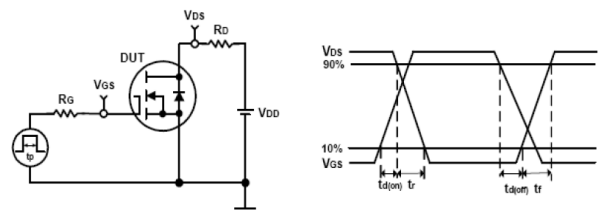
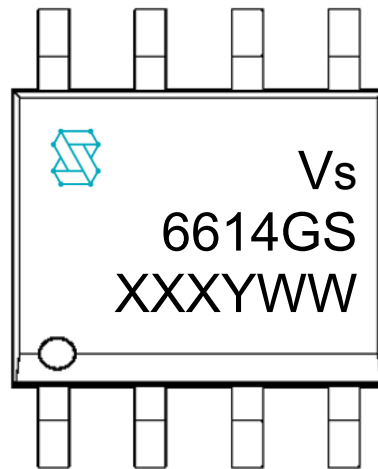

Fig11. Switching Time Test Circuit and waveforms

Marking Information



1st line: Vanguard Code (Vs), Vanguard Logo

2nd line: Part Number (6614GS)

3rd line: Date code (XXXYWW)

XXX: Wafer Lot Number Code , code changed with Lot Number

Y: Year Code, (e.g. E=2017, F=2018, G=2019, H=2020, etc)

WW: Week Code (01 to 53)

SOP8 Package Outline Data

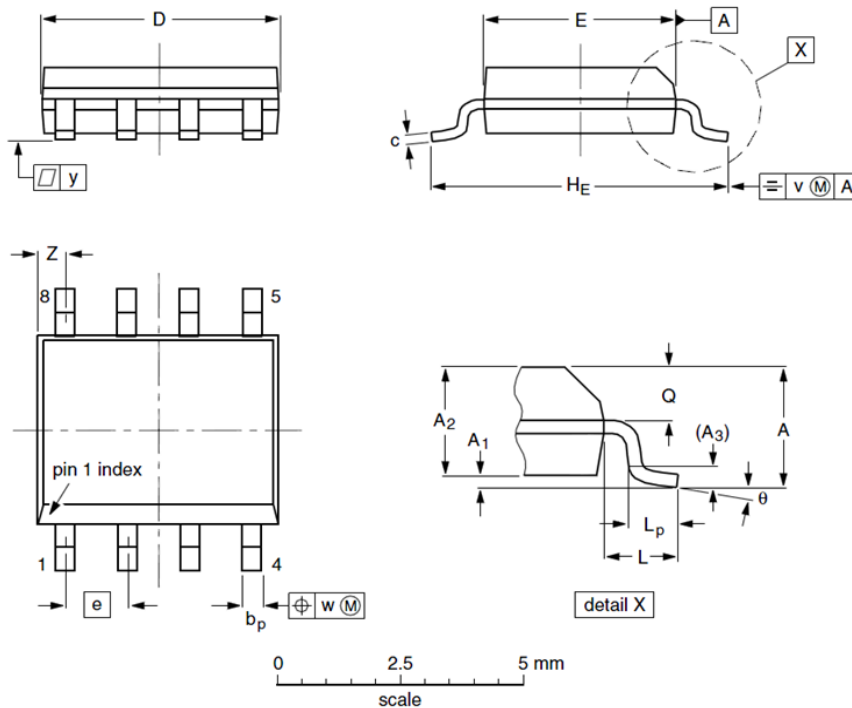

Label	Dimensions (unit: mm)		
	Min	Typ	Max
A	--	--	1.75
A ₁	0.10	0.18	0.25
A ₂	1.25	1.35	1.50
A ₃	--	0.25	--
b _p	0.36	0.42	0.51
c	0.19	0.22	0.25
D	4.80	4.92	5.00
E	3.80	3.90	4.00
e	--	1.27	--
H _E	5.80	6.00	6.20
L	--	1.05	--
L _p	0.40	0.68	1.00
Q	0.60	0.65	0.725
v	--	0.25	--
w	--	0.25	--
y	--	0.10	--
Z	0.30	0.50	0.70
θ	0°		8°

Notes:

1. Follow JEDEC MS-012.
2. Dimension "D" does NOT include mold flash, protrusions or gate burrs. Mold flash, protrusions or gate burrs shall not exceed 0.15mm per side.
3. Dimension "E" does NOT include interlead flash or protrusion. Interlead flash or protrusion shall not exceed 0.25mm per side.
4. Dimension "b_p" does NOT include dambar protrusion. Allowable dambar protrusion shall be 0.1mm total in excess of "b_p" dimension at maximum material condition. The dambar cannot be located on the lower radius of the foot.

Customer Service

Sales and Service:

sales@vgsemi.com

Vanguard Semiconductor CO., LTD

TEL: (86-755) -26902410

FAX: (86-755) -26907027

WEB: www.vgsemi.com

X-ON Electronics

Largest Supplier of Electrical and Electronic Components

Click to view similar products for [MOSFET](#) category:

Click to view products by [Vanguard](#) manufacturer:

Other Similar products are found below :

[614233C](#) [648584F](#) [IRFD120](#) [IRFF430](#) [JANTX2N5237](#) [2N7000](#) [FCA20N60_F109](#) [FDZ595PZ](#) [AOD464](#) [2SK2267\(Q\)](#) [2SK2545\(Q,T\)](#)
[405094E](#) [423220D](#) [MIC4420CM-TR](#) [VN1206L](#) [614234A](#) [715780A](#) [SSM6J414TU,LF\(T](#) [751625C](#) [BSC884N03MS G](#) [BSF024N03LT3 G](#)
[PSMN4R2-30MLD](#) [TK31J60W5,S1VQ\(O](#) [2SK2614\(TE16L1,Q\)](#) [DMN1017UCP3-7](#) [EFC2J004NUZTDG](#) [FCAB21350L1](#) [P85W28HP2F-](#)
[7071](#) [DMN1053UCP4-7](#) [NTE2384](#) [NTE2969](#) [NTE6400A](#) [DMN2080UCB4-7](#) [DMN61D9UWQ-13](#) [US6M2GTR](#) [DMN31D5UDJ-7](#)
[SSM6P54TU,LF](#) [DMP22D4UFO-7B](#) [IPS60R3K4CEAKMA1](#) [DMN1006UCA6-7](#) [DMN16M9UCA6-7](#) [STF5N65M6](#) [STU5N65M6](#)
[C3M0021120D](#) [DMN13M9UCA6-7](#) [BSS340NWH6327XTSA1](#) [MCM3400A-TP](#) [DMTH10H4M6SPS-13](#) [IRF40SC240ARMA1](#)
[IPS60R1K0PFD7SAKMA1](#)