

## Features

- N-Channel, 10V Logic Level Control
- Enhancement mode
- Very low on-resistance  $R_{DS(on)}$  @  $V_{GS}=10\text{ V}$
- 100% Avalanche test
- Pb-free lead plating; RoHS compliant



Part ID	Package Type	Marking	Tape and reel information
VS80N08AT	TO-220AB	80N08AT	50PCS/Tube

$V_{DS}$	80	V
$R_{DS(on),TYP} @ V_{GS}=10\text{ V}$	6.8	m $\Omega$
$I_D$	83	A

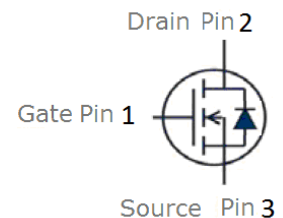
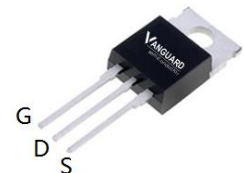
**TO-220AB**

## Maximum ratings, at $T_A=25^\circ\text{C}$ , unless otherwise specified

Symbol	Parameter	Rating	Unit
$V_{(BR)DSS}$	Drain-Source breakdown voltage	80	V
$I_S$	Diode continuous forward current	$T_C=25^\circ\text{C}$ 83	A
$I_D$	Continuous drain current @ $V_{GS}=10\text{V}$	$T_C=25^\circ\text{C}$ 83	A
		$T_C=100^\circ\text{C}$ 52	A
$I_{DM}$	Pulse drain current tested ①	$T_C=25^\circ\text{C}$ 332	A
$P_D$	Maximum power dissipation	$T_C=25^\circ\text{C}$ 150	W
$V_{GS}$	Gate-Source voltage	$\pm 20$	V
$T_{STG}, T_J$	Storage and junction temperature range	-55 to 175	$^\circ\text{C}$

## Thermal Characteristics

Symbol	Parameter	Typical	Unit
$R_{\theta JC}$	Thermal Resistance, Junction-to-Case	1.0	$^\circ\text{C/W}$
$R_{\theta JA}$	Thermal Resistance, Junction-to-Ambient	40	$^\circ\text{C/W}$

## Drain-Source Avalanche Ratings

EAS	Avalanche Energy, Single Pulsed ②	576	mJ
-----	-----------------------------------	-----	----

Symbol	Parameter	Condition	Min.	Typ.	Max.	Unit
<b>Static Electrical Characteristics @ <math>T_j = 25^\circ\text{C}</math> (unless otherwise stated)</b>						
$V_{(BR)DSS}$	Drain-Source Breakdown Voltage	$V_{GS}=0V, I_D=250\mu A$	80	--	--	V
$I_{DSS}$	Zero Gate Voltage Drain Current	$V_{DS}=80V, V_{GS}=0V$	--	--	1	$\mu A$
	Zero Gate Voltage Drain Current( $T_j=125^\circ\text{C}$ )	$V_{DS}=80V, V_{GS}=0V$	--	--	100	$\mu A$
$I_{GSS}$	Gate-Body Leakage Current	$V_{GS}=\pm 20V, V_{DS}=0V$	--	--	$\pm 100$	nA
$V_{GS(TH)}$	Gate Threshold Voltage	$V_{DS}=V_{GS}, I_D=250\mu A$	2.0	3.0	4.0	V
$R_{DS(ON)}$	Drain-Source On-State Resistance <sup>③</sup>	$V_{GS}=10V, I_D=40A$	--	6.8	8.0	m $\Omega$
<b>Dynamic Electrical Characteristics @ <math>T_j = 25^\circ\text{C}</math> (unless otherwise stated)</b>						
$C_{iss}$	Input Capacitance	$V_{DS}=30V, V_{GS}=0V,$ $f=1\text{MHz}$	--	2920	--	pF
$C_{oss}$	Output Capacitance		--	390	--	pF
$C_{rss}$	Reverse Transfer Capacitance		--	255	--	pF
$R_g$	Gate Resistance	$f=1\text{MHz}$	--	0.95	--	$\Omega$
$Q_g$	Total Gate Charge	$V_{DS}=40V, I_D=30A,$ $V_{GS}=10V$	--	88	--	nC
$Q_{gs}$	Gate-Source Charge		--	18	--	nC
$Q_{gd}$	Gate-Drain Charge		--	29	--	nC
<b>Switching Characteristics</b>						
$t_{d(on)}$	Turn-on Delay Time	$V_{DD}=40V,$ $I_D=20A,$ $R_G=6.8\Omega,$ $V_{GS}=10V$	--	17	--	nS
$t_r$	Turn-on Rise Time		--	69	--	nS
$t_{d(off)}$	Turn-Off Delay Time		--	50	--	nS
$t_f$	Turn-Off Fall Time		--	73	--	nS
<b>Source- Drain Diode Characteristics @ <math>T_j = 25^\circ\text{C}</math> (unless otherwise stated)</b>						
$V_{SD}$	Forward on voltage	$I_{SD}=40A, V_{GS}=0V$	--	0.87	1.2	V
$t_{rr}$	Reverse Recovery Time	$T_j=25^\circ\text{C}, I_{sd}=20A,$ $V_{GS}=0V$ $di/dt=500A/\mu s$	--	75	--	nS
$Q_{rr}$	Reverse Recovery Charge		--	180	--	nC

**NOTE:**

- ① Repetitive rating; pulse width limited by max. junction temperature.
- ② Limited by  $T_{jmax}$ , starting  $T_j = 25^\circ\text{C}$ ,  $L = 0.5\text{mH}, R_G = 25\Omega, I_{AS} = 48A, V_{GS} = 10V$ . Part not recommended for use above this value
- ③ Pulse width  $\leq 300\mu s$ ; duty cycle  $\leq 2\%$ .

Typical Characteristics

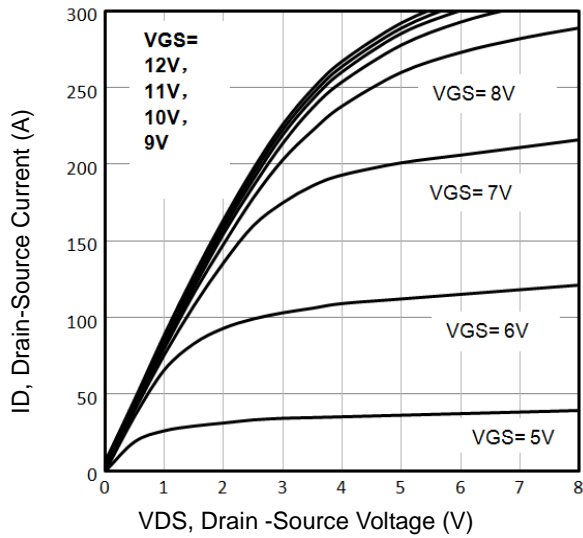

Fig1. Typical Output Characteristics

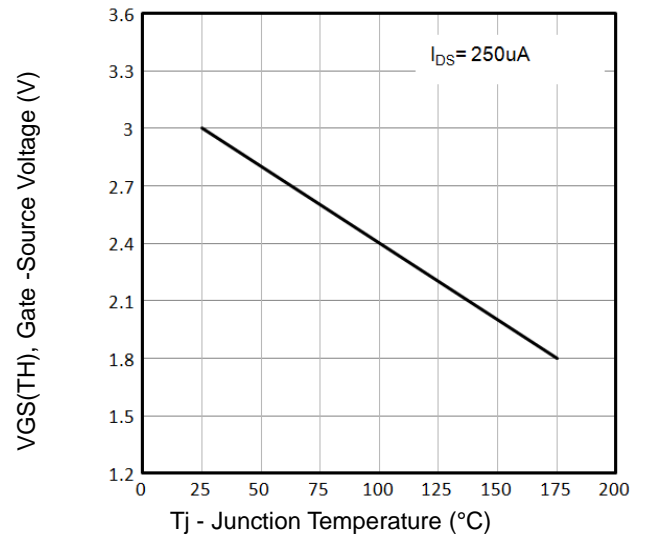

Fig2.  $V_{GS(TH)}$  Gate -Source Voltage Vs.  $T_j$

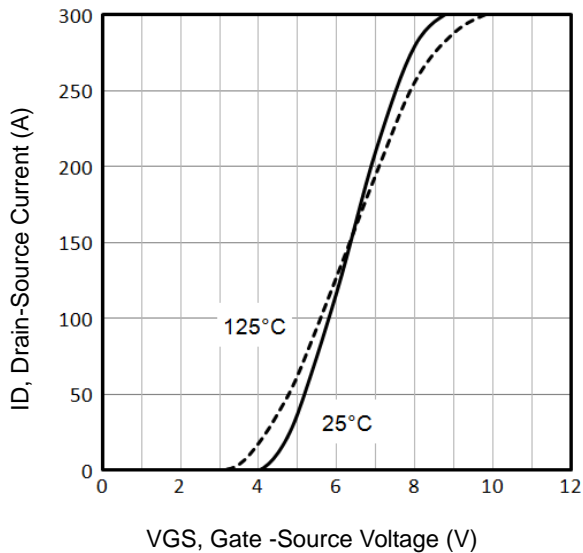

Fig3. Typical Transfer Characteristics

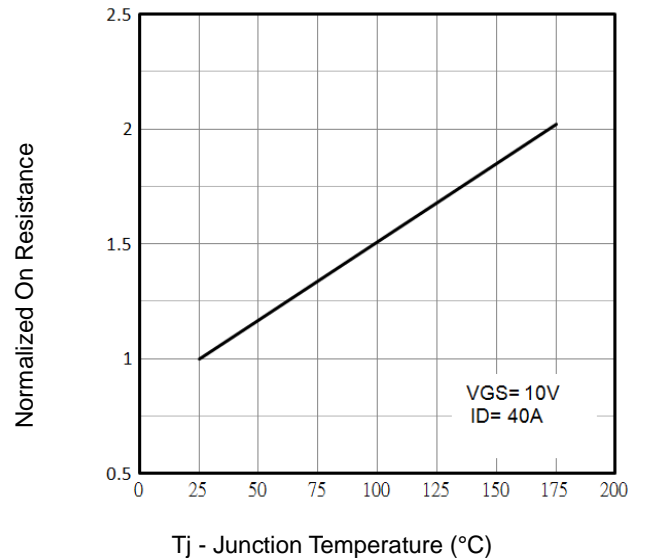

Fig4. Normalized On-Resistance Vs.  $T_j$

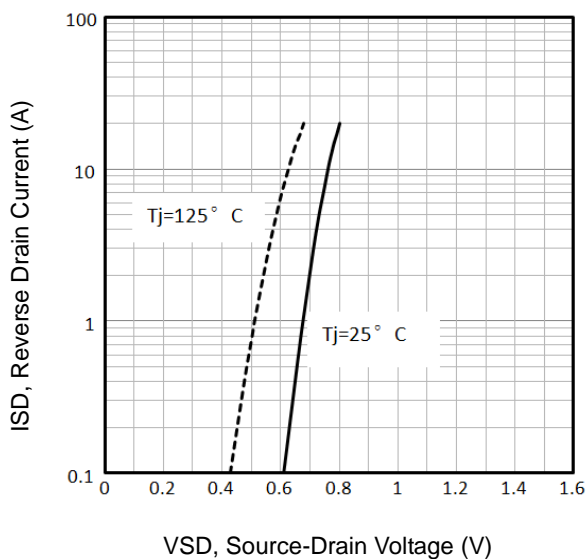

Fig5. Typical Source-Drain Diode Forward Voltage

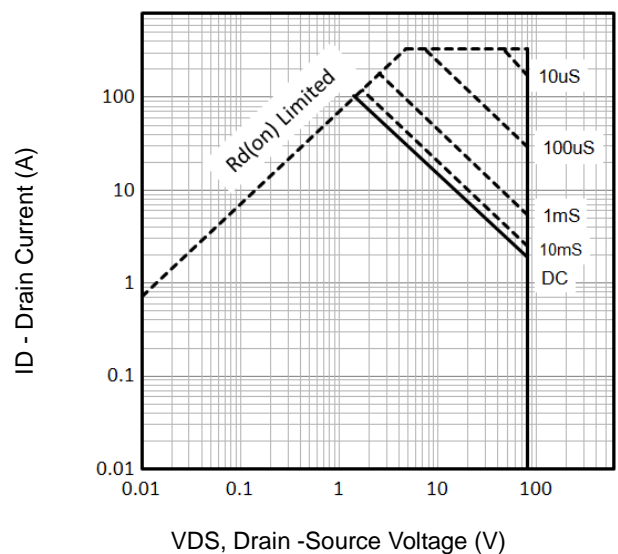

Fig6. Maximum Safe Operating Area

Typical Characteristics

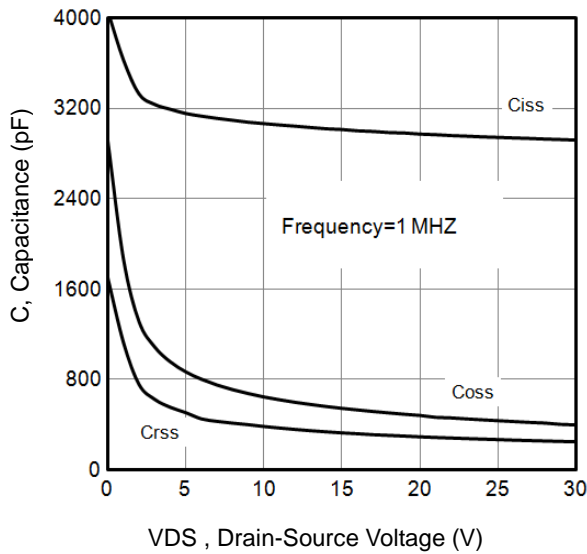

Fig7. Typical Capacitance Vs.Drain-Source Voltage

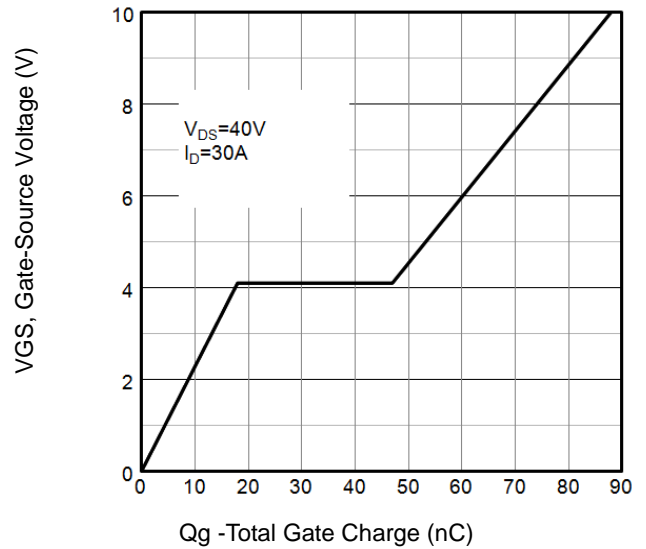

Fig8. Typical Gate Charge Vs.Gate-Source Voltage

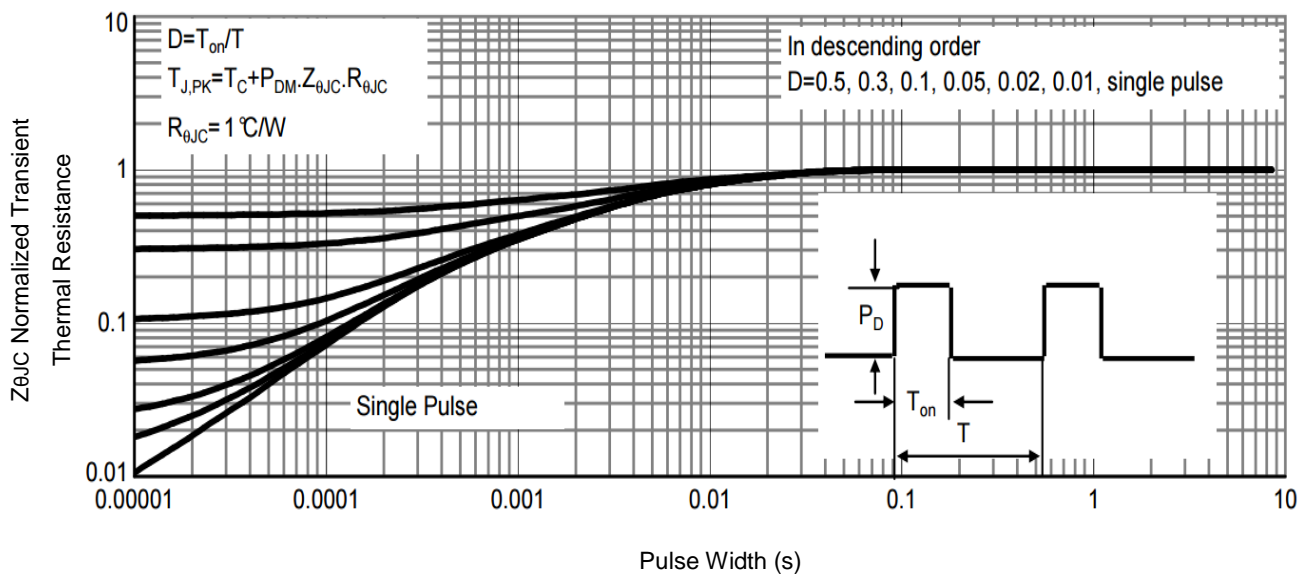

Fig9. Normalized Maximum Transient Thermal Impedance

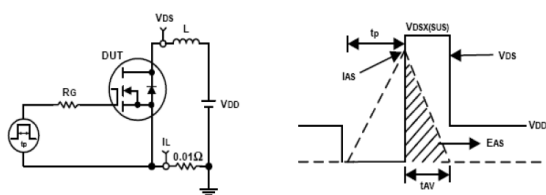

Fig10. Unclamped Inductive Test Circuit and waveforms

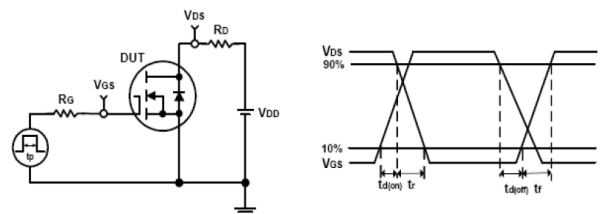
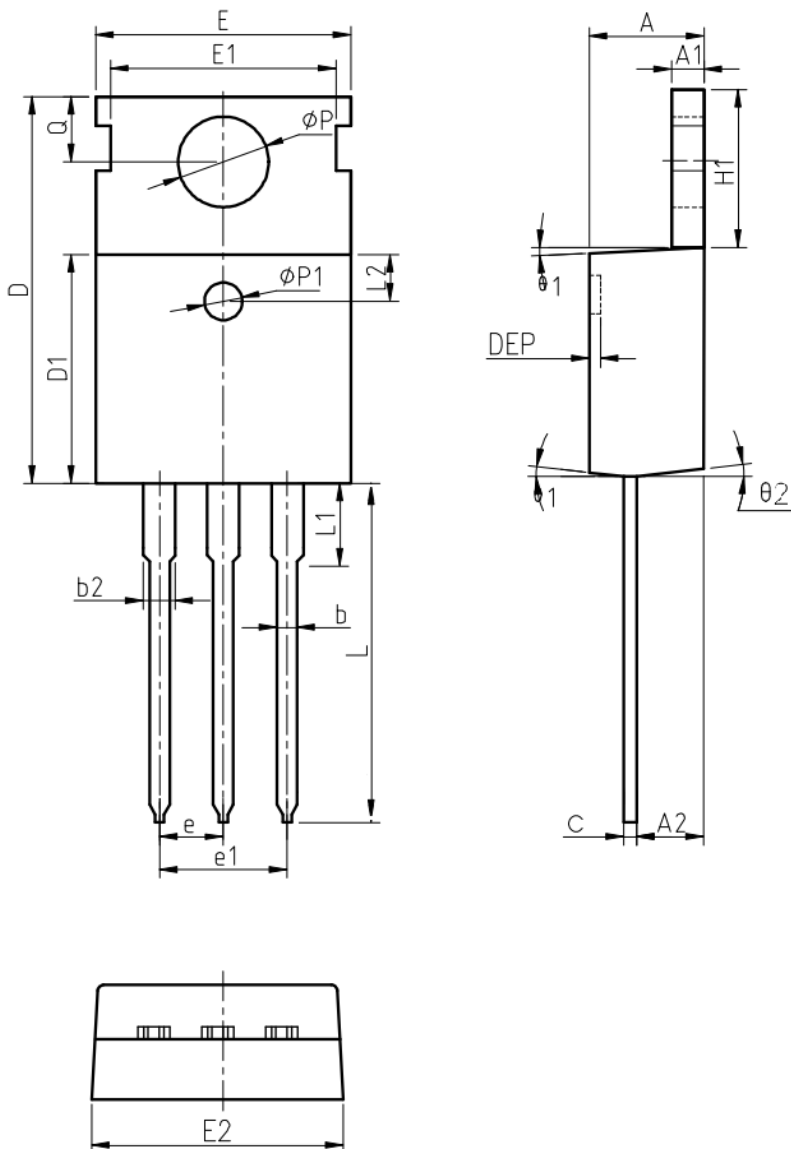

Fig11. Switching Time Test Circuit and waveforms

## TO-220AB Package Outline Data



Symbol	Dimensions (unit: mm)		
	Min	Typ	Max
<b>A</b>	4.30	4.52	4.70
<b>A1</b>	1.15	1.30	1.40
<b>A2</b>	2.20	2.40	2.60
<b>b</b>	0.70	0.80	1.00
<b>b2</b>	1.17	1.32	1.50
<b>c</b>	0.45	0.50	0.61
<b>D</b>	15.30	15.65	15.90
<b>D1</b>	9.00	9.20	9.40
<b>DEP</b>	0.05	0.10	0.25
<b>E</b>	9.66	9.90	10.28
<b>E1</b>	-	8.70	-
<b>E2</b>	9.80	10.00	10.20
$\phi P1$	1.40	1.50	1.60
<b>e</b>	2.54 BSC		
<b>e1</b>	5.08 BSC		
<b>H1</b>	6.40	6.50	6.80
<b>L</b>	12.70	-	14.27
<b>L1</b>	-	-	3.95
<b>L2</b>	2.40	2.50	2.60
$\phi P$	3.53	3.60	3.70
<b>Q</b>	2.70	2.80	2.90
$\theta1$	5 °	7 °	9 °
$\theta2$	1 °	3 °	5 °

**Notes:**

1. Refer to JEDEC TO-220 variation AB
2. Dimension "D" and "E" do NOT include mold flash. Mold flash shall not exceed 0.127mm per side.

## Customer Service

**Sales and Service:**

[sales@vgsemi.com](mailto:sales@vgsemi.com)

**Vanguard Semiconductor CO., LTD**

**TEL:** (86-755) -26902410

**FAX:** (86-755) -26907027

**WEB:** [www.vgsemi.com](http://www.vgsemi.com)

## X-ON Electronics

Largest Supplier of Electrical and Electronic Components

*Click to view similar products for [MOSFET](#) category:*

*Click to view products by [Vanguard](#) manufacturer:*

Other Similar products are found below :

[614233C](#) [648584F](#) [MCH3443-TL-E](#) [MCH6422-TL-E](#) [FDPF9N50NZ](#) [FW216A-TL-2W](#) [FW231A-TL-E](#) [APT5010JVR](#) [NTNS3A92PZT5G](#)  
[IRF100S201](#) [JANTX2N5237](#) [2SK2464-TL-E](#) [2SK3818-DL-E](#) [FCA20N60\\_F109](#) [FDZ595PZ](#) [STD6600NT4G](#) [FSS804-TL-E](#) [2SJ277-DL-E](#)  
[2SK1691-DL-E](#) [2SK2545\(Q,T\)](#) [D2294UK](#) [405094E](#) [423220D](#) [MCH6646-TL-E](#) [TPCC8103,L1Q\(CM](#) [367-8430-0972-503](#) [VN1206L](#)  
[424134F](#) [026935X](#) [051075F](#) [SBVS138LT1G](#) [614234A](#) [715780A](#) [NTNS3166NZT5G](#) [751625C](#) [873612G](#) [IRF7380TRHR](#)  
[IPS70R2K0CEAKMA1](#) [RJK60S3DPP-E0#T2](#) [RJK60S5DPK-M0#T0](#) [APT5010JVFR](#) [APT12031JFLL](#) [APT12040JVR](#) [DMN3404LQ-7](#)  
[NTE6400](#) [JANTX2N6796U](#) [JANTX2N6784U](#) [JANTXV2N5416U4](#) [SQM110N05-06L-GE3](#) [SIHF35N60E-GE3](#)