

## Features

- N-Channel
- Enhancement mode
- Very low on-resistance  $R_{DS(on)}$  @  $V_{GS}=4.5\text{ V}$
- Fast Switching
- 100% Avalanche test
- Pb-free lead plating; RoHS compliant



Part ID	Package Type	Marking	Tape and reel information
VSD013N10MS	TO-252	013N10M	3000PCS/Reel

$V_{DS}$	100	V
$R_{DS(on),TYP}@ V_{GS}=10\text{ V}$	11	m $\Omega$
$R_{DS(on),TYP}@ V_{GS}=4.5\text{ V}$	12	m $\Omega$
$I_D$	52	A

TO-252

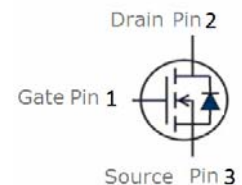

## Maximum ratings, at $T_j=25^\circ\text{C}$ , unless otherwise specified

Symbol	Parameter	Rating	Unit
$V_{(BR)DSS}$	Drain-Source breakdown voltage	100	V
$I_S$	Diode continuous forward current	$T_C=25^\circ\text{C}$	52 A
$I_D$	Continuous drain current @ $V_{GS}=10\text{V}$	$T_C=25^\circ\text{C}$	52 A
		$T_A=100^\circ\text{C}$	33 A
$I_{DM}$	Pulse drain current tested ①	$T_C=25^\circ\text{C}$	150 A
EAS	Avalanche energy, single pulsed ②	$I_D=18\text{A}$	60 mJ
IAS	Avalanche energy, single pulsed ②		20 A
$P_D$	Maximum power dissipation	$T_A=25^\circ\text{C}$	78 W
$V_{GS}$	Gate-Source voltage	$\pm 20$	V
$T_{STG} T_J$	Storage and operating temperature range	-55 to 175	$^\circ\text{C}$

## Thermal Characteristics

Symbol	Parameter	Typical	Unit
$R_{\theta JC}$	Thermal Resistance-Junction to Case	1.9	$^\circ\text{C/W}$
$R_{\theta JA}$	Thermal Resistance Junction-Ambient	60	$^\circ\text{C/W}$

Symbol	Parameter	Condition	Min.	Typ.	Max.	Unit
<b>Static Electrical Characteristics @ T<sub>c</sub> = 25°C (unless otherwise stated)</b>						
V <sub>(BR)DSS</sub>	Drain-Source Breakdown Voltage	V <sub>GS</sub> =0V I <sub>D</sub> =250μA	100	--	--	V
I <sub>DSS</sub>	Zero Gate Voltage Drain Current(T <sub>c</sub> =25°C)	V <sub>DS</sub> =100V, V <sub>GS</sub> =0V	--	--	1	μA
	Zero Gate Voltage Drain Current(T <sub>c</sub> =125°C)	V <sub>DS</sub> =100V, V <sub>GS</sub> =0V	--	--	100	μA
I <sub>GSS</sub>	Gate-Body Leakage Current	V <sub>GS</sub> =±20V, V <sub>DS</sub> =0V	--	--	±100	nA
V <sub>GS(TH)</sub>	Gate Threshold Voltage	V <sub>DS</sub> =V <sub>GS</sub> , I <sub>D</sub> =250μA	1.0	2.0	3.0	V
R <sub>DS(ON)</sub>	Drain-Source On-State Resistance <sup>③</sup>	V <sub>GS</sub> =10V, I <sub>D</sub> =25A	--	11	13	mΩ
R <sub>DS(ON)</sub>	Drain-Source On-State Resistance <sup>③</sup>	V <sub>GS</sub> =4.5V, I <sub>D</sub> =5A	--	12	15	mΩ
<b>Dynamic Electrical Characteristics @ T<sub>c</sub> = 25°C (unless otherwise stated)</b>						
C <sub>iss</sub>	Input Capacitance	V <sub>DS</sub> =20V, V <sub>GS</sub> =0V, f=1MHz	--	3625	--	pF
C <sub>oss</sub>	Output Capacitance		--	225	--	pF
C <sub>rss</sub>	Reverse Transfer Capacitance		--	140	--	pF
Q <sub>g</sub>	Total Gate Charge	V <sub>DS</sub> =50V, I <sub>D</sub> =4A, V <sub>GS</sub> =10V	--	83	--	nC
Q <sub>gs</sub>	Gate-Source Charge		--	12	--	nC
Q <sub>gd</sub>	Gate-Drain Charge		--	16.5	--	nC
<b>Switching Characteristics</b>						
t <sub>d(on)</sub>	Turn-on Delay Time	V <sub>DD</sub> =50V, I <sub>D</sub> =4A, R <sub>G</sub> =6.8Ω, V <sub>GS</sub> =10V	--	23	--	nS
t <sub>r</sub>	Turn-on Rise Time		--	112	--	nS
t <sub>d(off)</sub>	Turn-Off Delay Time		--	50	--	nS
t <sub>f</sub>	Turn-Off Fall Time		--	100	--	nS
<b>Source- Drain Diode Characteristics @ T<sub>c</sub> = 25°C (unless otherwise stated)</b>						
V <sub>SD</sub>	Forward on voltage	I <sub>SD</sub> =25A, V <sub>GS</sub> =0V	--	0.83	1.20	V
t <sub>rr</sub>	Reverse Recovery Time	T <sub>j</sub> =25°C, I <sub>sd</sub> =4A, V <sub>GS</sub> =0V	--	33	--	nS
Q <sub>rr</sub>	Reverse Recovery Charge	di/dt=100A/μs		42		nC

**NOTE:**

- ① Repetitive rating; pulse width limited by max. junction temperature.
- ② Limited by T<sub>jmax</sub>, starting T<sub>J</sub> = 25°C, L = 0.3mH, R<sub>G</sub> = 25Ω, I<sub>AS</sub> = 20A, V<sub>GS</sub> = 10V. Part not recommended for use above this value
- ③ Pulse width ≤ 300μs; duty cycle ≤ 2%.

**Typical Characteristics**

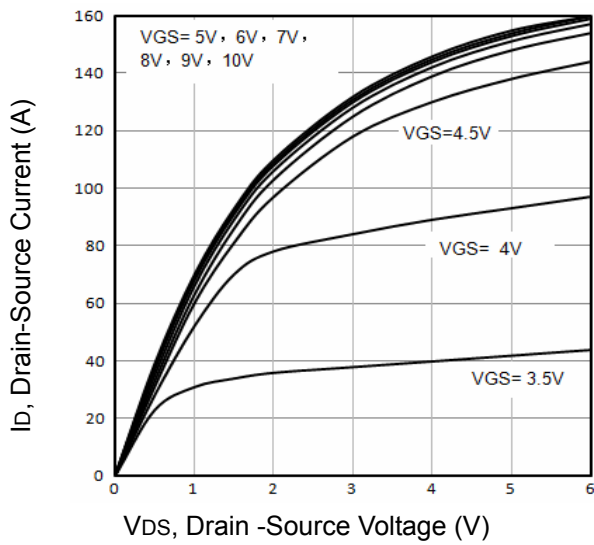

Fig1. Typical Output Characteristics

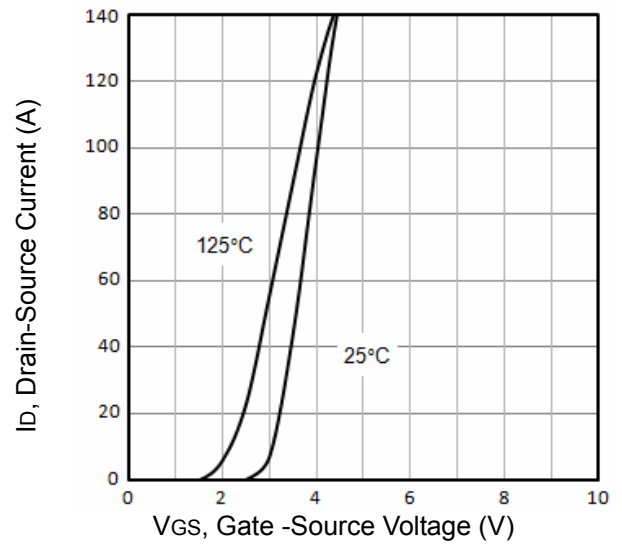

Fig2. Typical Transfer Characteristics

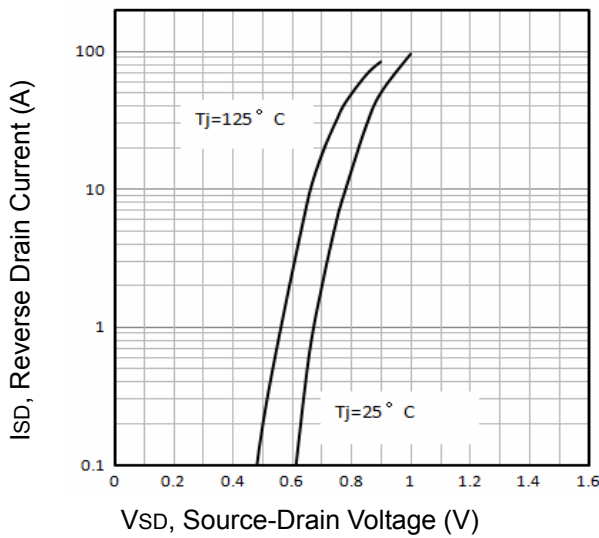

Fig3. Typical Source-Drain Diode Forward

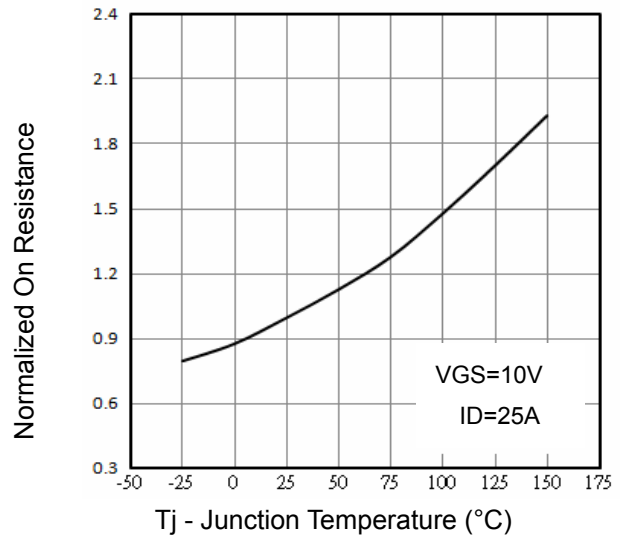

Fig4. Normalized On-Resistance Vs. Temperature

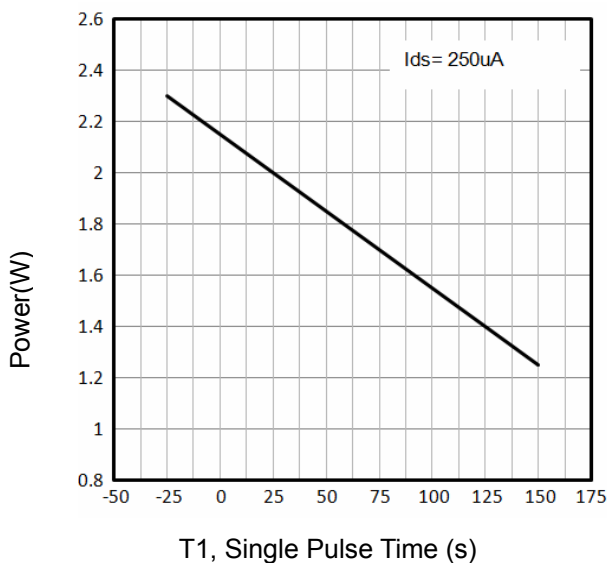

Fig5. Single Pulse Maximum Power Dissipation

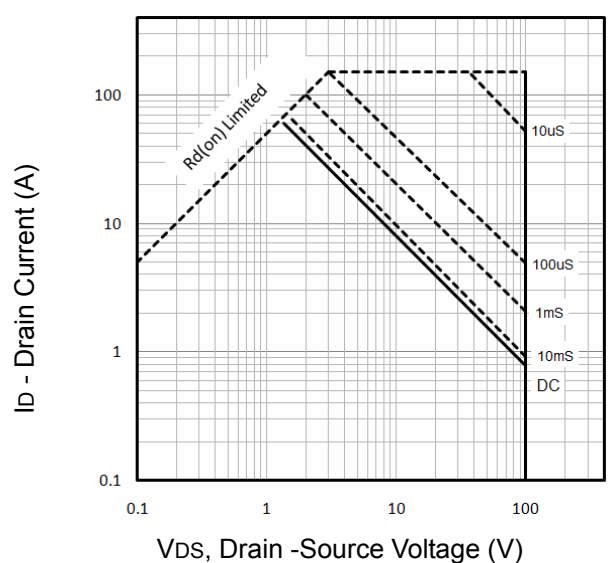

Fig6. Maximum Safe Operating Area

**Typical Characteristics**

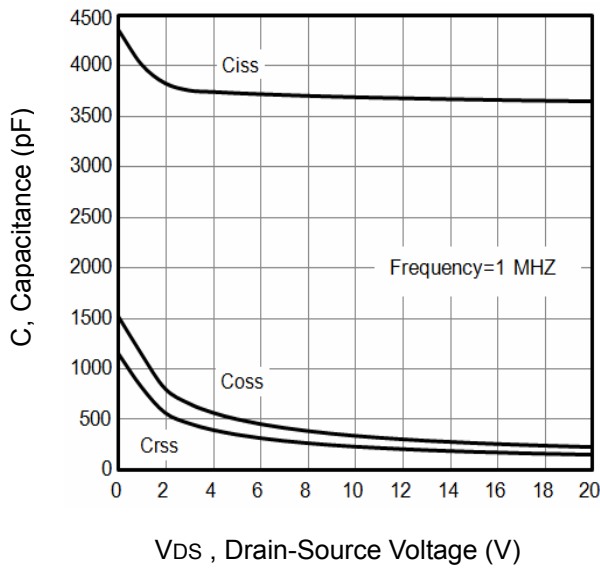

Fig7. Typical Capacitance Vs.Drain-Source Voltage

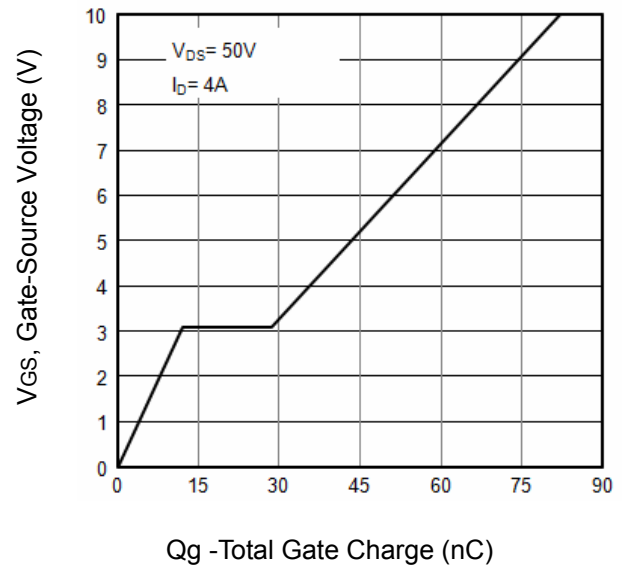

Fig8. Typical Gate Charge Vs.Gate-Source Voltage

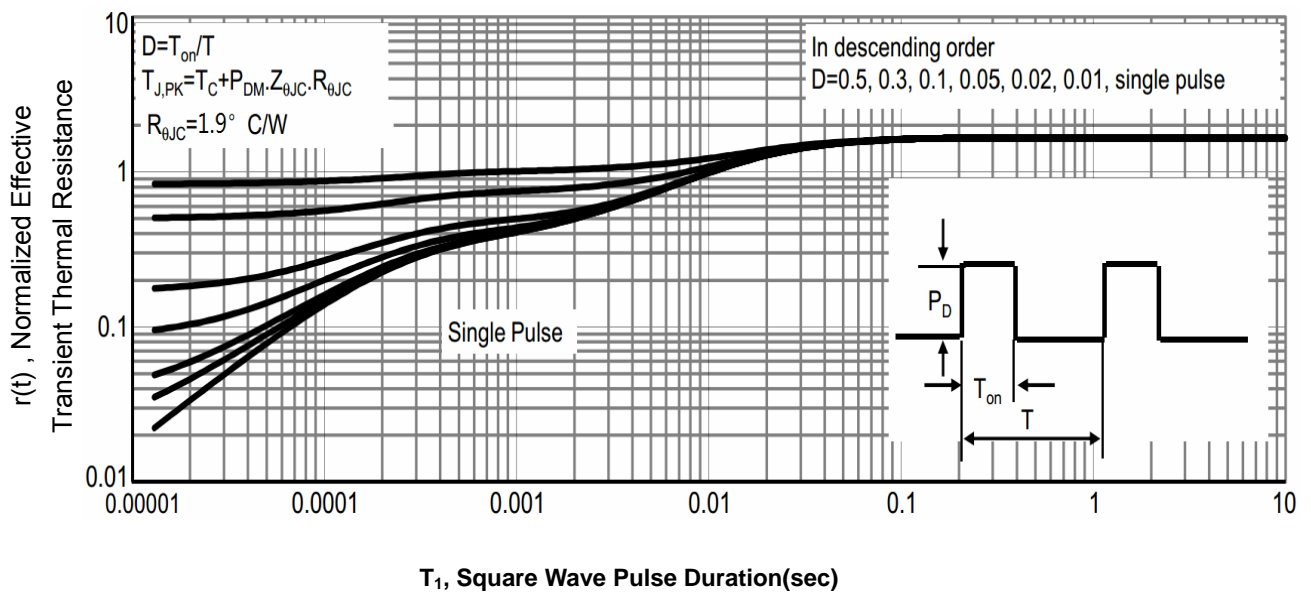

Fig9. T1, Transient Thermal Response Curve

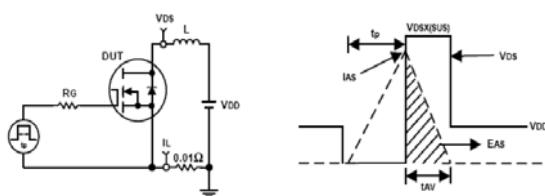

Fig10. Unclamped Inductive Test Circuit and waveforms

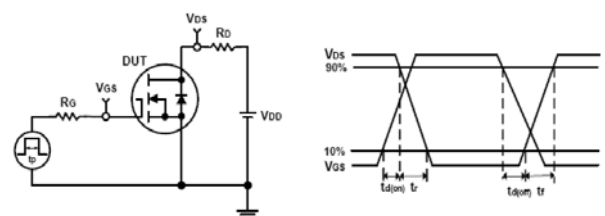
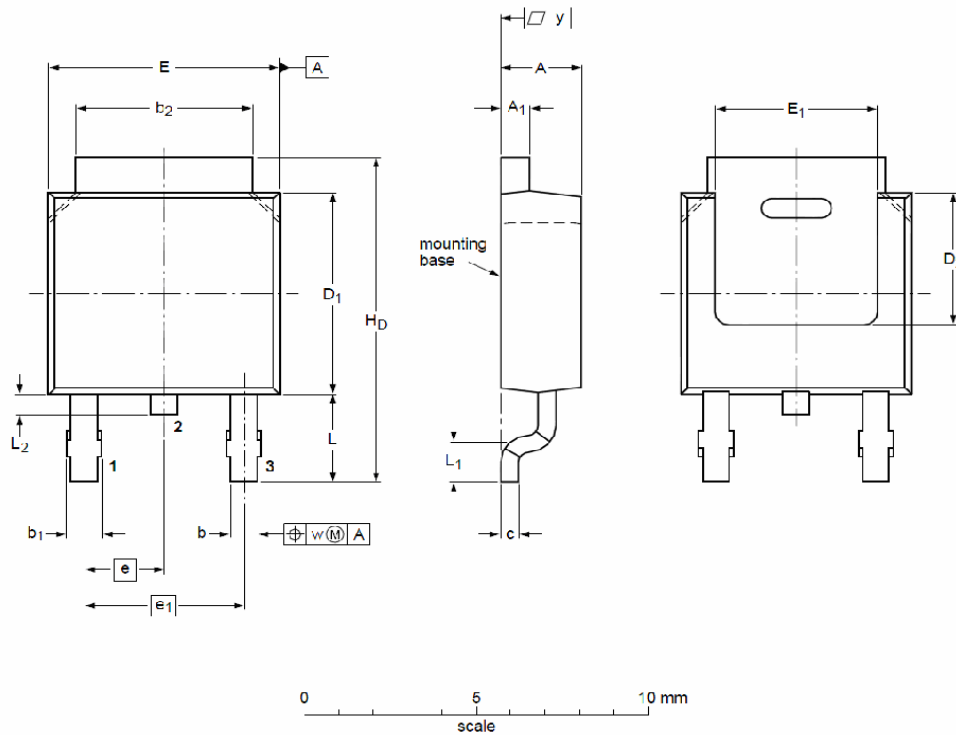

Fig11. Switching Time Test Circuit and waveforms

## TO-252 Package Outline



DIMENSIONS ( unit : mm )

Symbol	Min	Typ	Max	Symbol	Min	Typ	Max
A	2.22	2.30	2.38	A <sub>1</sub>	0.46	0.58	0.93
b	0.71	0.79	0.89	b <sub>1</sub>	0.90	0.98	1.10
b <sub>2</sub>	5.00	5.30	5.46	c	0.20	0.40	0.56
D <sub>1</sub>	5.98	6.05	6.22	D <sub>2</sub>	--	4.00	--
E	6.47	6.60	6.73	E <sub>1</sub>	5.10	5.28	5.45
e	--	2.28	--	e <sub>1</sub>	--	4.57	--
H <sub>D</sub>	9.60	10.08	10.40	L	2.75	2.95	3.05
L <sub>1</sub>	--	0.50	--	L <sub>2</sub>	0.80	0.90	1.10
w	--	0.20	--	y	0.20	--	--

## Customer Service

Sales and Service:

[sales@vgsemi.com](mailto:sales@vgsemi.com)

Vanguard Semiconductor CO., LTD

TEL: (86-755) -26902410

FAX: (86-755) -26907027

WEB: [www.vgsemi.com](http://www.vgsemi.com)

## X-ON Electronics

Largest Supplier of Electrical and Electronic Components

*Click to view similar products for [MOSFET](#) category:*

*Click to view products by [Vanguard](#) manufacturer:*

Other Similar products are found below :

[614233C](#) [648584F](#) [MCH3443-TL-E](#) [MCH6422-TL-E](#) [FDPF9N50NZ](#) [FW216A-TL-2W](#) [FW231A-TL-E](#) [APT5010JVR](#) [NTNS3A92PZT5G](#)  
[IRF100S201](#) [JANTX2N5237](#) [2SK2464-TL-E](#) [2SK3818-DL-E](#) [FCA20N60\\_F109](#) [FDZ595PZ](#) [STD6600NT4G](#) [FSS804-TL-E](#) [2SJ277-DL-E](#)  
[2SK1691-DL-E](#) [2SK2545\(Q,T\)](#) [D2294UK](#) [405094E](#) [423220D](#) [MCH6646-TL-E](#) [TPCC8103,L1Q\(CM](#) [367-8430-0972-503](#) [VN1206L](#)  
[424134F](#) [026935X](#) [051075F](#) [SBVS138LT1G](#) [614234A](#) [715780A](#) [NTNS3166NZT5G](#) [751625C](#) [873612G](#) [IRF7380TRHR](#)  
[IPS70R2K0CEAKMA1](#) [RJK60S3DPP-E0#T2](#) [RJK60S5DPK-M0#T0](#) [APT5010JVFR](#) [APT12031JFLL](#) [APT12040JVR](#) [DMN3404LQ-7](#)  
[NTE6400](#) [JANTX2N6796U](#) [JANTX2N6784U](#) [JANTXV2N5416U4](#) [SQM110N05-06L-GE3](#) [SIHF35N60E-GE3](#)