

## Features

- N-Channel, 5V Logic Level Control
- Enhancement mode
- Low on-resistance  $R_{DS(on)}$  @  $V_{GS}=4.5\text{ V}$
- VitoMOS® II Technology
- 100% Avalanche test
- Pb-free lead plating; RoHS compliant

**Halogen-Free**

Part ID	Package Type	Marking	Tape and reel information
VSP008N10MSC	PDFN5x6	008N10MC	3000PCS/Reel

$V_{DS}$	100	V
$R_{DS(on),TYP} @ V_{GS}=10\text{ V}$	6.2	mΩ
$R_{DS(on),TYP} @ V_{GS}=4.5\text{ V}$	7.7	mΩ
$I_D$	85	A

### PDFN5x6

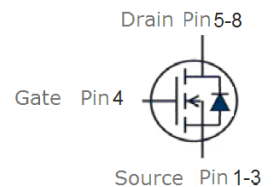
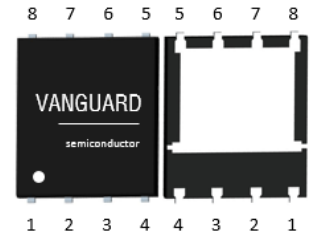

## Maximum ratings, at $T_A = 25^\circ\text{C}$ , unless otherwise specified

Symbol	Parameter	Rating	Unit
$V_{(BR)DSS}$	Drain-Source breakdown voltage	100	V
$V_{GS}$	Gate-Source voltage	±20	V
$I_S$	Diode continuous forward current	$T_C = 25^\circ\text{C}$	85 A
$I_D$	Continuous drain current @ $V_{GS}=10\text{V}$	$T_C = 25^\circ\text{C}$	85 A
		$T_C = 100^\circ\text{C}$	53 A
$I_{DM}$	Pulse drain current tested ①	$T_C = 25^\circ\text{C}$	340 A
$I_{DSM}$	Continuous drain current @ $V_{GS}=10\text{V}$	$T_A = 25^\circ\text{C}$	21 A
		$T_A = 70^\circ\text{C}$	16.5 A
EAS	Avalanche energy, single pulsed ②	104	mJ
$P_D$	Maximum power dissipation	$T_C = 25^\circ\text{C}$	69 W
$P_{DSM}$	Maximum power dissipation ③	$T_A = 25^\circ\text{C}$	4 W
$T_{STG}, T_J$	Storage and Junction Temperature Range	-55 to 150	°C

## Thermal Characteristics

Symbol	Parameter	Typical	Unit
$R_{\theta JC}$	Thermal Resistance, Junction-to-Case	1.8	°C/W
$R_{\theta JA}$	Thermal Resistance, Junction-to-Ambient	30	°C/W

**Electrical Characteristics**

Symbol	Parameter	Condition	Min.	Typ.	Max.	Unit
<b>Static Electrical Characteristics @ T<sub>j</sub>=25°C (unless otherwise stated)</b>						
V <sub>(BR)DSS</sub>	Drain-Source Breakdown Voltage	V <sub>GS</sub> =0V, I <sub>D</sub> =250μA	100	--	--	V
I <sub>DSS</sub>	Zero Gate Voltage Drain Current	V <sub>DS</sub> =100V, V <sub>GS</sub> =0V	--	--	1	μA
	Zero Gate Voltage Drain Current(T <sub>j</sub> =125°C)	V <sub>DS</sub> =100V, V <sub>GS</sub> =0V	--	--	100	μA
I <sub>GSS</sub>	Gate-Body Leakage Current	V <sub>GS</sub> =±20V, V <sub>DS</sub> =0V	--	--	±100	nA
V <sub>GS(TH)</sub>	Gate Threshold Voltage	V <sub>DS</sub> =V <sub>GS</sub> , I <sub>D</sub> =250μA	1.2	1.7	2.3	V
R <sub>DS(ON)</sub>	Drain-Source On-State Resistance <sup>④</sup>	V <sub>GS</sub> =10V, I <sub>D</sub> =20A	--	6.2	8	mΩ
R <sub>DS(ON)</sub>	Drain-Source On-State Resistance <sup>④</sup>	V <sub>GS</sub> =4.5V, I <sub>D</sub> =15A	--	7.7	11	mΩ
<b>Dynamic Electrical Characteristics @ T<sub>j</sub> = 25°C (unless otherwise stated)</b>						
C <sub>iss</sub>	Input Capacitance	V <sub>DS</sub> =30V, V <sub>GS</sub> =0V, f=1MHz	1460	1720	1975	pF
C <sub>oss</sub>	Output Capacitance		935	1100	1265	pF
C <sub>rss</sub>	Reverse Transfer Capacitance		60	75	85	pF
R <sub>g</sub>	Gate Resistance	f=1MHz	--	2.3	--	Ω
Q <sub>g</sub>	Total Gate Charge	V <sub>DS</sub> =30V, I <sub>D</sub> =20A, V <sub>GS</sub> =10V	--	31	--	nC
Q <sub>gs</sub>	Gate-Source Charge		--	7.8	--	nC
Q <sub>gd</sub>	Gate-Drain Charge		--	7.5	--	nC
<b>Switching Characteristics</b>						
t <sub>d(on)</sub>	Turn-on Delay Time	V <sub>DD</sub> =30V, I <sub>D</sub> =20A, R <sub>G</sub> =3Ω, V <sub>GS</sub> =10V	--	9.9	--	ns
t <sub>r</sub>	Turn-on Rise Time		--	6	--	ns
t <sub>d(off)</sub>	Turn-Off Delay Time		--	29.3	--	ns
t <sub>f</sub>	Turn-Off Fall Time		--	8.5	--	ns
<b>Source- Drain Diode Characteristics @ T<sub>j</sub> = 25°C (unless otherwise stated)</b>						
V <sub>SD</sub>	Forward on voltage	I <sub>SD</sub> =20A, V <sub>GS</sub> =0V	--	0.8	1.2	V
t <sub>rr</sub>	Reverse Recovery Time	T <sub>j</sub> =25°C, I <sub>sd</sub> =20A, V <sub>GS</sub> =0V di/dt=500A/μs	--	21	--	ns
Q <sub>rr</sub>	Reverse Recovery Charge		--	38.7	--	nC

**NOTE:**

- ① Repetitive rating; pulse width limited by max junction temperature.
- ② Limited by T<sub>Jmax</sub>, starting T<sub>J</sub> = 25°C, L = 0.5mH, R<sub>G</sub> = 25Ω, I<sub>AS</sub> = 16A, V<sub>GS</sub> = 10V. Part not recommended for use above this value.
- ③ The power dissipation P<sub>DSM</sub> is based on R<sub>θJA</sub> and the maximum allowed junction temperature of 150°C.
- ④ Pulse width ≤ 300μs; duty cycles ≤ 2%.

**Typical Characteristics**

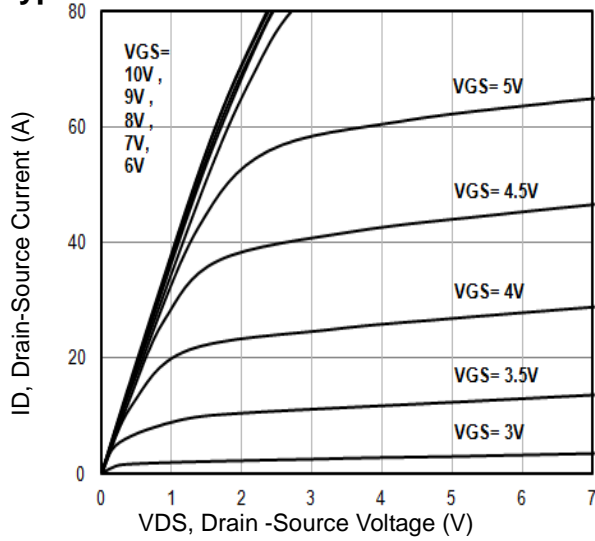

**Fig1.** Typical Output Characteristics

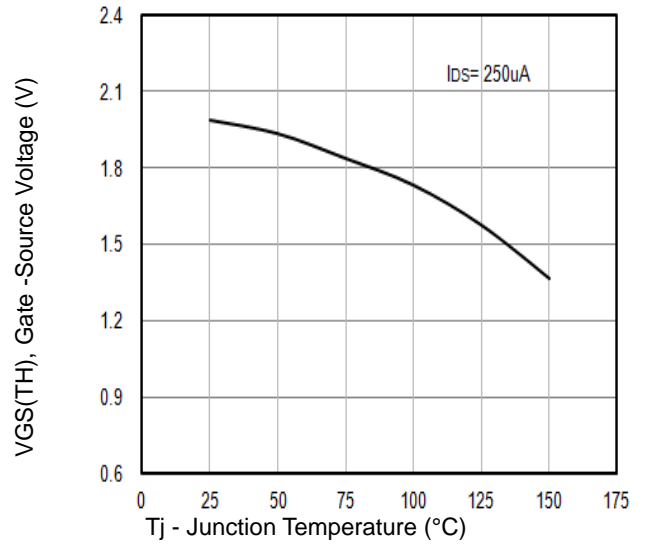

**Fig2.**  $V_{GS(TH)}$  Gate -Source Voltage Vs.  $T_j$

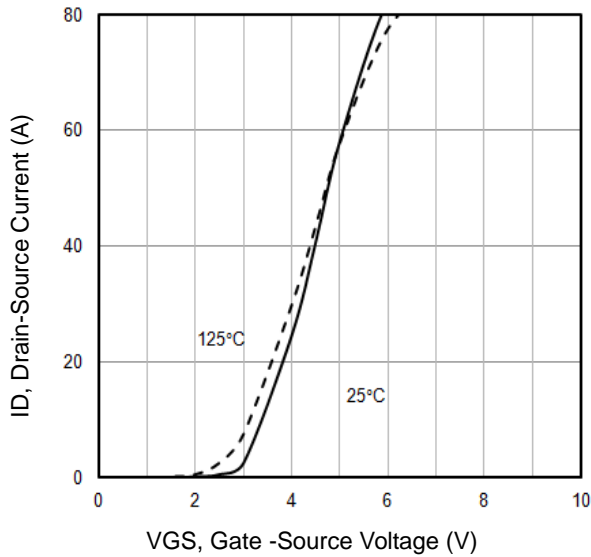

**Fig3.** Typical Transfer Characteristics

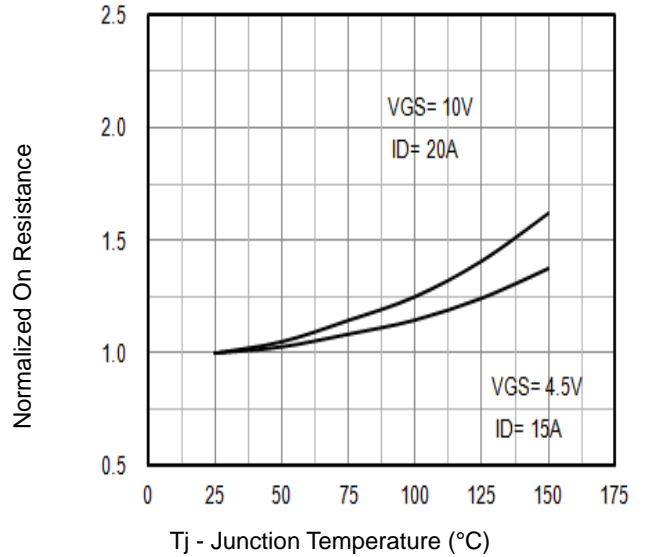

**Fig4.** Normalized On-Resistance Vs.  $T_j$

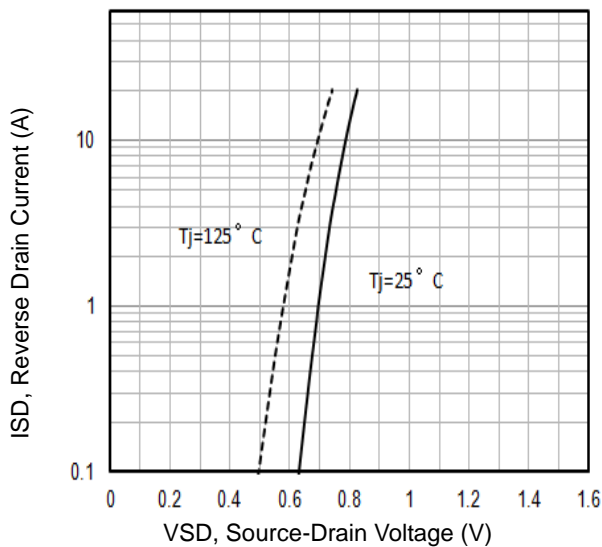

**Fig5.** Typical Source-Drain Diode Forward Voltage

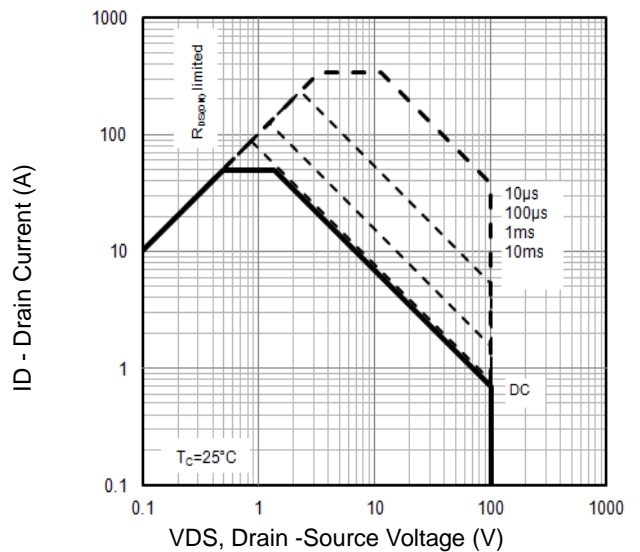

**Fig6.** Maximum Safe Operating Area

Typical Characteristics

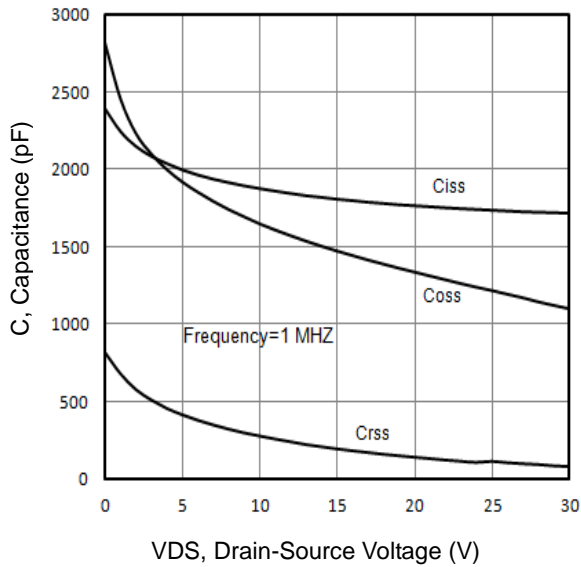

Fig7. Typical Capacitance Vs. Drain-Source Voltage

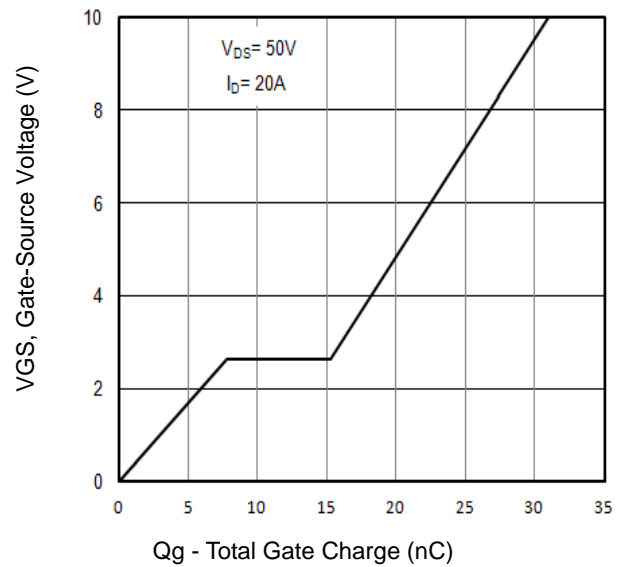

Fig8. Typical Gate Charge Vs. Gate-Source Voltage

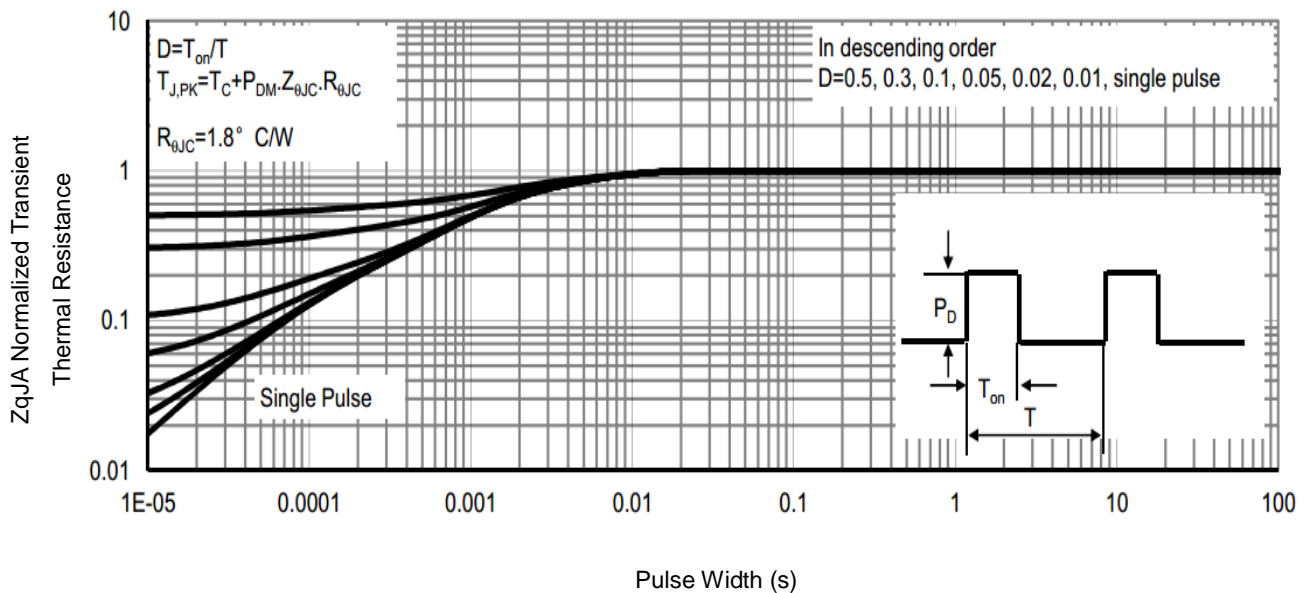

Fig9. Normalized Maximum Transient Thermal Impedance

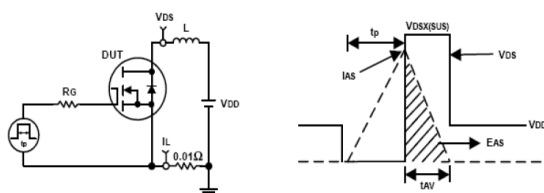

Fig10. Unclamped Inductive Test Circuit and waveforms

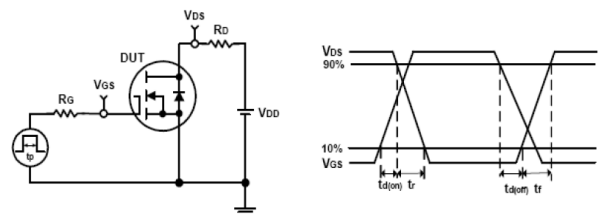
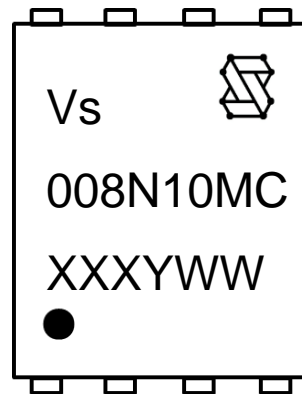

Fig11. Switching Time Test Circuit and waveforms

## Marking Information



1st line: Vanguard Code (Vs), Vanguard Logo

2nd line: Part Number (008N10MC)

3rd line: Date code (XXXYYWW)

XXX: Wafer Lot Number Code , code changed with Lot Number

Y: Year Code, (e.g. E=2017, F=2018, G=2019, H=2020, etc)

WW: Week Code (01 to 53)

PDFN5x6 Package Outline Data

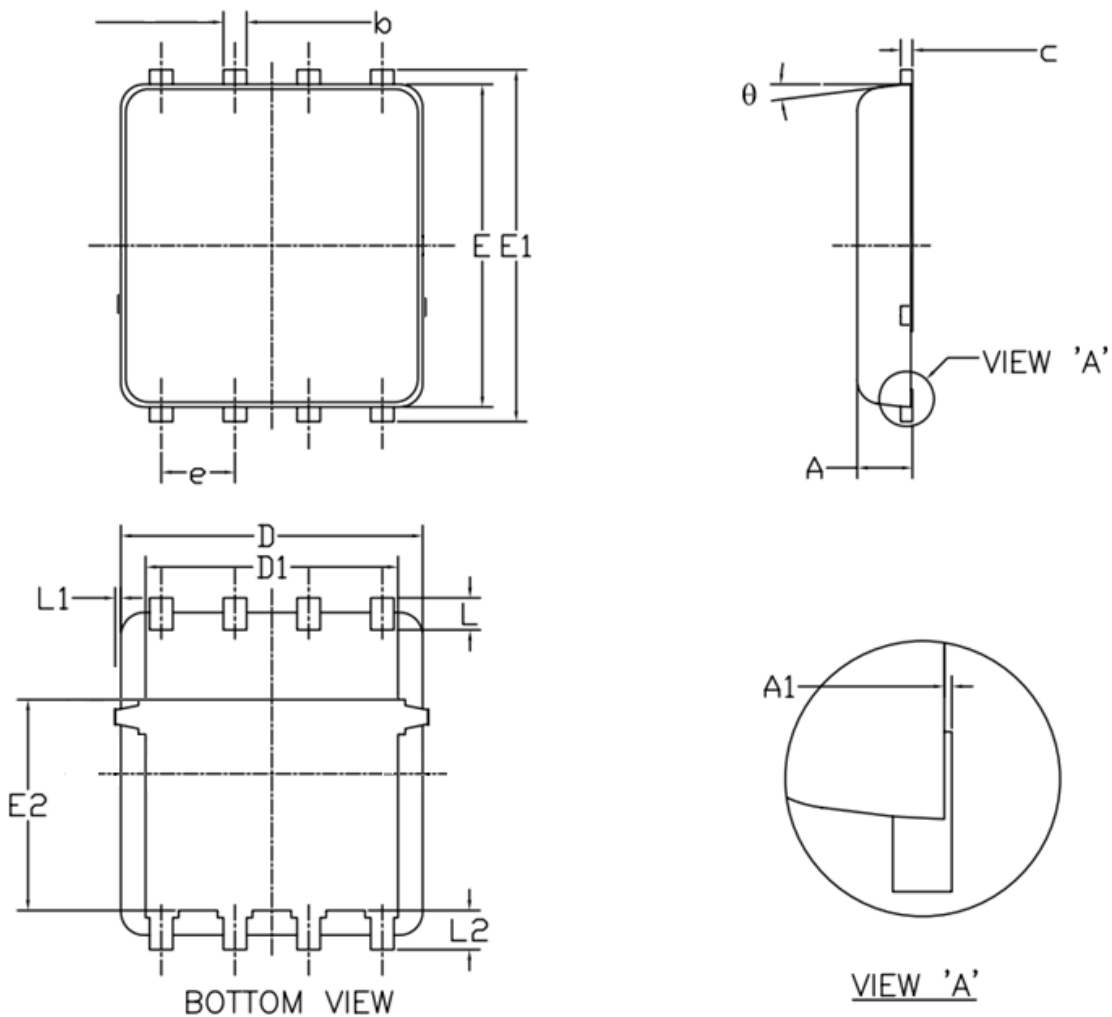

Symbol	DIMENSIONS ( unit : mm )		
	Min	Typ	Max
A	0.90	1.00	1.20
A1	0.00	--	0.05
b	0.30	0.40	0.51
c	0.20	0.25	0.33
D	4.80	4.90	5.40
D1	3.61	4.00	4.25
E	5.65	5.80	6.06
E1	5.90	6.10	6.35
E2	3.38	3.58	3.92
e	1.27 BSC		
L	0.51	0.61	0.71
L1	--	--	0.15
L2	0.41	0.51	0.61
θ	0°	--	12°

Notes:

1. Refer to JEDEC MO-240 variation AA.
2. Dimensions "D" and "E" do NOT include mold flash protrusions or gate burrs.
3. Dimensions "D" and "E" include interterminal flash or protrusion. Interterminal flash or protrusion shall not exceed 0.25mm per side.

Customer Service

Sales and Service:

[sales@vgsemi.com](mailto:sales@vgsemi.com)

Vanguard Semiconductor CO., LTD

TEL: (86-755) -26902410

FAX: (86-755) -26907027

WEB: [www.vgsemi.com](http://www.vgsemi.com)

## X-ON Electronics

Largest Supplier of Electrical and Electronic Components

*Click to view similar products for [MOSFET](#) category:*

*Click to view products by [Vanguard](#) manufacturer:*

Other Similar products are found below :

[614233C](#) [648584F](#) [MCH3443-TL-E](#) [MCH6422-TL-E](#) [FDPF9N50NZ](#) [FW216A-TL-2W](#) [FW231A-TL-E](#) [APT5010JVR](#) [NTNS3A92PZT5G](#)  
[IRF100S201](#) [JANTX2N5237](#) [2SK2464-TL-E](#) [2SK3818-DL-E](#) [FCA20N60\\_F109](#) [FDZ595PZ](#) [STD6600NT4G](#) [FSS804-TL-E](#) [2SJ277-DL-E](#)  
[2SK1691-DL-E](#) [2SK2545\(Q,T\)](#) [D2294UK](#) [405094E](#) [423220D](#) [MCH6646-TL-E](#) [TPCC8103,L1Q\(CM](#) [367-8430-0972-503](#) [VN1206L](#)  
[424134F](#) [026935X](#) [051075F](#) [SBVS138LT1G](#) [614234A](#) [715780A](#) [NTNS3166NZT5G](#) [751625C](#) [873612G](#) [IRF7380TRHR](#)  
[IPS70R2K0CEAKMA1](#) [RJK60S3DPP-E0#T2](#) [RJK60S5DPK-M0#T0](#) [APT5010JVFR](#) [APT12031JFLL](#) [APT12040JVR](#) [DMN3404LQ-7](#)  
[NTE6400](#) [JANTX2N6796U](#) [JANTX2N6784U](#) [JANTXV2N5416U4](#) [SQM110N05-06L-GE3](#) [SIHF35N60E-GE3](#)