

# 惠州市嵩隆力上电子有限公司

## 直热式负温度系数热敏电阻器

Directly heated negative temperature coefficient thermistors

### 规格书

NTC Specification

客户名称:

CUSTOMER NAME \_\_\_\_\_

产品名称:

PART NAME MF 72 NTC 热敏电阻

产品规格:

PART NUMBER NTC5D-9 (内弯/F=7.5/L3.5)

签发日期:

ISSUE DATE 2022.10.02

确 认

CONFIRM

拟制 <i>Prepared</i>	审核 <i>Checked</i>	批准 <i>Approved</i>	日期 <i>Date</i>
刘美玲	邓江清	简宪靖	2022.10.2

惠州市嵩隆力上电子有限公司

HUIZHOU SHI SONGLONG LISHANG ELECTRONICS CO.,LTD

Heng-Ling Developing Distict ,SatianTown,

Hui-Yang,Hui-Zhou,Guang Dong Province, P.R.C.

惠州市惠阳区沙田镇田头横岭开发区

TEL:0752-3728085

FAX:0752-3728399

# 惠州市嵩隆力上电子有限公司

目录	页码
CATALOG	page number
➤ 产品特点	
Feature of Power Thermistor	1
➤ 资质认证	
Quality Certification	1
➤ 产品代码	
PARTNUMBER	1
➤ 技术参数	
Technical parameters	2-7
➤ 一般参数	
Common Parameters	5-6
➤ 热敏电阻选用原则	
Principle of thermal resistor is chosen	7-9
➤ 存储条件	
Storage condition	9-10
➤ 产品性能	
properties of products	10-12
➤ 电阻-温度关系曲线	
Graph of Resistance vs. Temperature	13-18
➤ 产品标志说明	
Part Number Explanation	19
➤ 包装	
Packing	20-22
➤ NTC 热敏电阻注意事项	
NTC thermistor to use matters needing attention	23

# 1、产品特点 Feature of Power Thermistor

## 1.1 应用范围 Application

- 转换电源，开关电源，UPS 电源 ○Switching power-supply, switch power, up power
- 镇流器及各类加热器 ○Electronic energy saving lamp electronic ballast and all kinds of electric heater
- 各类显像管，显示器 ○All kinds of RT, display
- 电子节能灯，其他照明灯具 ○Bulb and other lighting lamps

## 1.2 特点 Characteristic

- 体积小，功率大，抑制浪涌电流能力强 ○Small size, large power, strong capacity of suppression of inrush current
- 反应速度快 ○Fast response
- 材料常数(B 值)大，残余电阻小 ○Big material constant (B value), small residual resistance
- 寿命长，可靠性高 ○Long life and high reliability
- 系列全，应用范围宽 ○Complete series, wide application

# 2、资质认证 Quality Certification

中性标：ROHS、REACH

# 3、产品代码 PART NUMBER

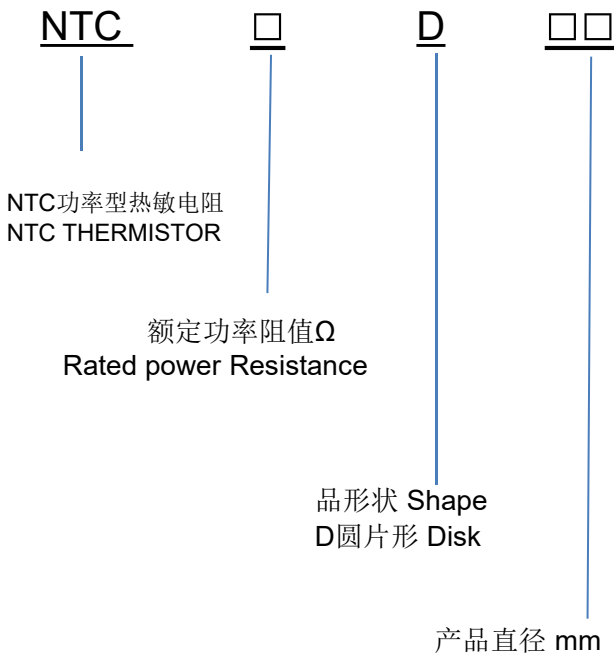

#### 4、技术参数 technical parameters

型号 Part No	R <sub>25</sub> (Ω)	最大稳态电流 Max.steady State current (A)	残余电阻* Residual Resistance (Ω)	耗散系数* Dissipation factor (mw/℃)	热时间常数* Thermal time Constant (s)	工作温度 Operating Temperature (℃)
5D-5	5	1	0.35	约 6	约 20	-40~+150
8D-5	8	0.7	0.77			
10D-5	10	0.7	0.77			
20D-5	20	0.5	0.997			
33D-5	33	0.5	1.88			
5D-7	5	2	0.28	约 9	约 30	-40~+150
8D-7	8	1	0.77			
10D-7	10	1	0.77			
12D-7	12	1	0.82			
16D-7	16	0.7	1.00			
20D-7	20	0.6	1.11			
22D-7	22	0.6	1.11			
33D-7	33	0.5	1.49			
3D-9	3	4	0.12	约 11	约 35	-40~+175
5D-9	5	3	0.21			
6D-9	6	2	0.32			
8D-9	8	2	0.40			
10D-9	10	2	0.46			
12D-9	12	1	0.66			
15D-9	15	1	0.80			

型号 Part No	R <sub>25</sub> (Ω)	最大稳态电流 Max.steady State current (A)	残余电阻* Residual Resistance (Ω)	耗散系数* Dissipation factor (mw/℃)	热时间常数* Thermal time Constant (s)	工作温度 Operating Temperature (℃)
16D-9	16	1	0.80	约 11	约 35	-40~+175
20D-9	20	1	0.88			
22D-9	22	1	0.95			
33D-9	33	1	1.12			
50D-9	50	1	1.25			
100D-9	100	0.8	3.02			
120D-9	120	0.8	3.02			
2.5D- 11	2.5	5	0.10	约 14	约 50	-40~+175
3D- 11	3	5	0.10			
4D- 11	4	4	0.15			
5D- 11	5	4	0.16			
8D- 11	8	3	0.25			
10D- 11	10	3	0.28			
12D- 11	12	2	0.46			
15D- 11	15	2	0.47			
16D- 11	16	2	0.47			
20D- 11	20	2	0.51			
22D- 11	22	2	0.56			
33D- 11	33	1.5	0.67			
47D- 11	47	1.5	1.02			
50D- 11	50	1.5	1.22			
2.5D- 13	2.5	6	0.088	约 15	约 68	-40~+200
3D- 13	3	6	0.092			
4.7D- 13	4.7	5	0.12			
5D- 13	5	5	0.125			
8D- 13	8	4	0.194			
10D- 13	10	4	0.206			

型号 Part No	R <sub>25</sub> (Ω)	最大稳态电流 Max.steady State current (A)	残余电阻* Residual Resistance (Ω)	耗散系数* Dissipation factor (mw/℃)	热时间常数* Thermal time Constant (s)	工作温度 Operating Temperature (℃)
16D-13	16	3	0.335	约 15	约 68	-40~+200
18D-13	18	3	0.372			
20D-13	20	3	0.372			
30D-13	30	2.5	0.517			
47D-13	47	2	0.81			
1.5D-15	1.5	8	0.071	约 18	约 86	-40~+200
2.5D-15	2.5	8	0.071			
3D-15	3	7	0.075			
5D-15	5	6	0.112			
7D-15	7	5	0.173			
8D-15	8	5	0.178			
10D-15	10	5	0.18			
15D-15	15	4	0.268			
16D-15	16	4	0.268			
18D-15	18	4	0.288			
20D-15	20	4	0.288			
30D-15	30	3.5	0.438			
47D-15	47	3	0.68			
50D-15	50	3	0.72			
1.3D-20	1.3	9	0.037			
1.5D-20	1.5	9	0.037			
2.5D-20	2.5	8	0.055			
3D-20	3	8	0.055			
5D-20	5	7	0.087			
8D-20	8	6	0.142			
10D-20	10	6	0.162			
16D-20	16	5	0.212			
20D-20	20	5	0.212			

#### 4.1、一般参数 (Common Parameters) :

#### 引线图

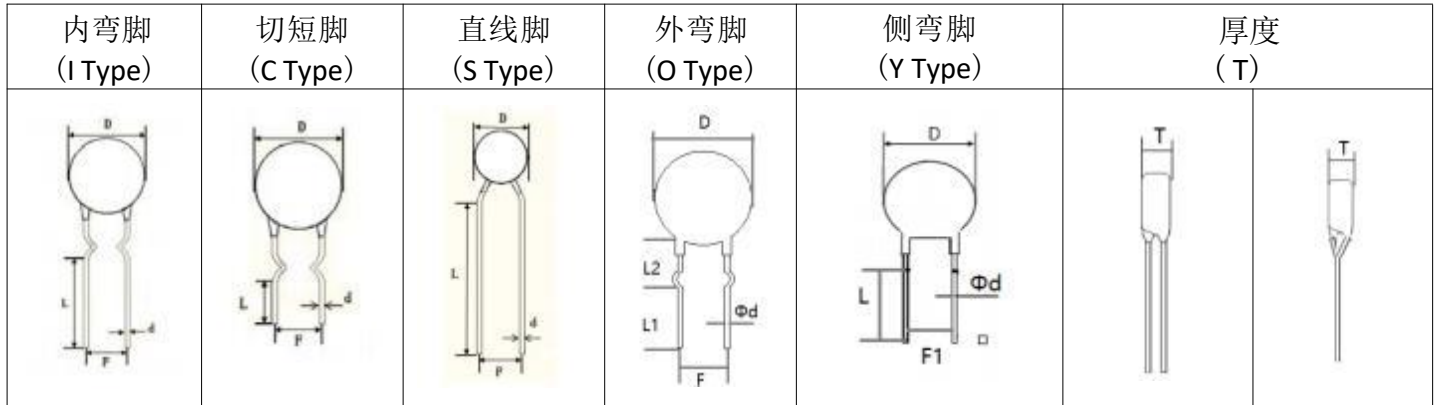

#### 产品尺寸

尺寸 Dim (mm)Sym 代号 型号 Part No	Dmax	Tmax	∅d ±0.1	F1 ±1	F2 ±1.5	直脚 Straight Lead Wire	弯脚 Curved Lead wire		Y型脚 Y Lead wire
						L±1	L1±0.5	L2±2	L±1
NTC□D-5	7	5	0.55	5	3	2.8-20	2.8-20	7或4	2.8-20
NTC□D-7	9	5	0.55	5	3	2.8-20	2.8-20	7或4	2.8-20
<b>NTC□D-9</b>	<b>11</b>	<b>5.5</b>	<b>0.75/0.55</b>	<b>7.5/5</b>	<b>5/3</b>	<b>2.8-20</b>	<b>2.8-20</b>	<b>7或4</b>	<b>2.8-20</b>
NTC□D-11	13	5.5	0.75	7.5/5	5/3	2.8-20	2.8-20	7或4	2.8-20
NTC□D-13	15.5	6	0.75	7.5	5	2.8-20	2.8-20	7或4	2.8-20
NTC□D-15	17.5	6	0.75	10/7.5	5	2.8-20	2.8-20	7或4	2.8-20
NTC□D-20	22.5	7	1.0	10	8	2.8-20	2.8-20	7或4	2.8-20

备注: □ 为额定零功率电阻值。  
□ Rated zero-power resistance

#### (1) 引线形状 Lead the shape

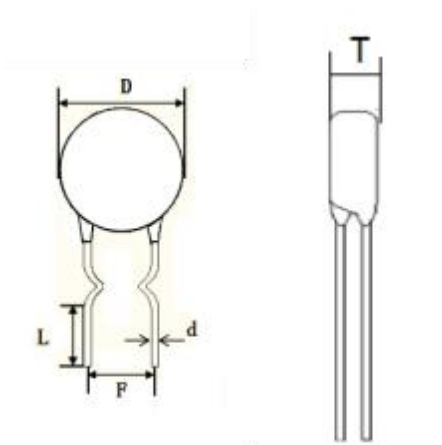

#### (2) 产品尺寸 Product size

型号	最大直径 Dmax	最大厚度 Tmax	引线直径 ∅d±0.05mm	间距 F±1mm	引线长度 L±0.5
<b>5D-9</b>	<b>11mm</b>	<b>5.5mm</b>	<b>0.75mm</b>	<b>7.5mm</b>	<b>3.5mm</b>

### (3) 材料 (Materials)

①封装材料 (Wrapper) : 酚醛树脂 (Modified phenolic resin)

②引线 (Down-lead) : CP 线 (CP Wire)

③、颜色 (Coating color) : 黑色 (Black)

#### 印字方式

	NTC	负温度系数热敏电阻器 NTC thermistor
	5	额定零功率电阻值 5 Ω
	D	圆片型 Disk-Type
	9	直径 8±1 (mm)
	标志颜色	白色(white)

### 4.2、主要技术参数 (Parameters of Technology) :

① 25℃时零功率电阻值(Ω) ( Zero Power Resistance at 25℃) : 5±20%

② 热时间常数(S) (Thermal Time Constant): 约 35

③ 热耗散系数(mW/℃) (Thermal Dissipation Constant ) : 约 11

④ 工作温度(℃) (Operating Temperature) : -40~+175

⑤ 最大稳态电流(A) (Max Steady State Current) : 3

⑥ 最大允许使用容量值(240Vac) : 220μF

Maximum allowable capacity value (240Vac) : 220μF

⑦ 绝缘电阻值 : >1000 MΩ, 将热敏电阻的引出端连接起来作为一个电极, 金属箔作为另一个电极, 在两电极间施加直流电压 500V±15V 测量两个电极间的绝缘电阻, 施加电压的时间为 1min, 绝缘电阻不小于 1000 MΩ;

Insulation resistance: 1000 MΩ ohm, the terminal of the thermistor connected as an electrode, metal foil as another electrode, 500V ± 15V DC voltage is applied between the two electrodes measure the insulation resistance between the two electrodes, the voltage applied to the time of 1min, the insulation resistance of not less than 1000 MΩ;

⑧ 耐电压 : 将热敏电阻的引出端连接起来作为一个电极, 金属箔作为另一个电极, 在两电极间施加一个频率为 40Hz-60Hz, 取规定绝缘电压 1.4 倍的 AC 电压(AC500V) 为峰值电压, 持续时间为 60s±5s, 电压应近似于 100V / s 的速率逐步施加, 热敏电阻器



应无击穿或飞弧。

High voltage terminal: thermistor connected as an electrode, metal foil as another electrode in two electrode applied between a frequency of 40Hz-60Hz, AC voltage and insulation voltage of 1.4 times the provisions (AC500V) for the duration of the peak voltage, 60s + 5S, the rate of voltage should be similar to the 100V / s thermistor applied gradually, there should be no breakdown or arcing.

⑨ B 值(K) (B Value) : 2700 ± 10%

用以下公式表示指数: Using the following formula

$$B = \left[ \frac{T_a \times T_b}{T_b - T_a} \right] \times \ln(R_a / R_b)$$

或者

$$B = 2.303 \times \left[ \frac{T_a \times T_b}{T_b - T_a} \right] \times \log(R_a / R_b)$$

公式中:

B-- 常数(单位为 K) Constant (unit K)

R<sub>a</sub>-- 在温度 T<sub>a</sub> (单位为 K) 下测定的零功率电阻值(单位为 Ω);

R<sub>b</sub>-- 在温度 T<sub>b</sub> (单位为 K) 下测定的零功率电阻值(单位为 Ω)。

T<sub>a</sub>=298.15K

T<sub>b</sub>=358.15K

B 值是材料系数或指热敏指数, B 值的大小由材料特性决定, B 值允许±10%公差范围, 影响 B 值大小的因素属材料特性; B 值不同, 残余电阻大小不同, 持续工作时温升也不同; B 值越大, 残余电阻越小, 工作时温升越小。

B value is the material coefficient or thermal index, B value is decided by the size of the material properties, allowing the + 5% tolerance range of B value, B value influence the size of the material properties; the B values are different, the residual resistance of different sizes, continuous working temperature rise is also different; the bigger the B value, the residual resistance is small when the temperature rise is small.

## 5、热敏电阻选用原则 Principle of thermal resistor is chosen

### 5.1 热敏电阻的最大工作电流 > 回路的工作电流

Thermistor maximum operating current > loop operating current

## 5.2 热电阻的标称电阻值 $R \geq 1.414 * E / I_m$

Nominal resistance values of thermal resistance  $R \geq 1.414 * E / I_m$

E 为线路电压 E is the line voltage  $I_m$ 为浪涌电流  $I_m$  a surge current 一般来讲对于开关电源 转换电源 不间断电源 逆变电源等  $I_m=100$  倍工作电流对于灯丝加热器等的电路  $I_m=30$  倍工作电流

In general, the switching power supply, switching power supplies, uninterruptible power supplies, power inverter and other times operating current  $I_m = 100$  For the filament heater circuit like  $I_m = 30$  times the operating current.

## 5.3 B 值越大，残余电阻越小，工作时温升越小。

B The larger the value, the smaller the residual resistance, the smaller the temperature rise during operation.

## 5.4 热时间常数和耗散系数两者为互为依赖的关系，并不是说某一个数值越大越好或越小越好，而是两者的乘积越大说明热敏电阻的热容量就越大，那么抗浪涌电流的能力就越强。

Thermal time constant and dissipation factor as both mutually dependent relationship, not to say that one or the greater the value, the better the smaller the better, but the product of the two greater the heat capacity of the thermistor greater, then resistance to surge current, the stronger

## 5.5 热敏电阻用于电源电路时主要是用来抑制开机时的大浪涌电流，大的浪涌电流是电容放电产生，所以电路中所要安装的滤波储能电容的选配也是很关键的一个条件，为确保热敏电阻器能够安全的起到保护电路的作用，所以要求电源设计厂家也应该充分考虑这一因素。

When the power supply circuit for the thermistor is mainly used to suppress large inrush current at power-on, a large inrush current is the capacitor discharge, the filter to be installed in the tank circuit capacitance matching is a very critical condition to ensure that

the thermistor circuit can play a role in security protection, so the powersupply design requirements for manufacturers should also take full account of this factor.

5.6 通过电路中的最大工作电压和最大启动电流等参数可以利用公式  $R=U/I$ 计算出电阻值范围。

Through the circuit maximum operating voltage and maximum starting current and other parameters can use the formula  $R = U / I$  calculated the resistance value range.

5.7 以上这些选用原则可以锁定出 NTC 热敏电阻的对应型号， 如果贵司有特殊设计需要可与我司技术部洽谈。

These principles may choose to lock the NTC thermistor corresponding model, if your company has special design needs with our technical department to discuss.

## 6、存储条件 **Storage condition**

### 6.1 存贮环境条件

温度 Temperature	-10℃ ~+40℃
湿度 Humidity	≤70%RH
期限 Term	≤1年（先进先出 First-in/ First-out）
地点 Place	<p>1. 不要暴露在下列环境条件下， 否则将导致性能衰退或参数漂移 <i>Do not exposing the components to the following conditions, otherwise, it may result in deterioration of characteristics</i></p> <p>2. 腐蚀性或易氧化气体 <i>Corrosive gas or deoxidizing gas</i></p> <p>3. 易燃易爆气体 <i>Flammable and explosive gases</i></p> <p>4. 油、水和化学溶液 <i>Oil, water and chemical liquid</i></p> <p>5. 太阳光下 <i>Under the sunlight</i></p>



## 7.2 电气性能 Electrical Characteristics

电气性能 ELECTRICAL CHARACTERISTICS		
测试条件/方法 Test Conditions & Method		
指标项目 Item	技术要求 Specification	测试条件/方法 Test Conditions & Methods
额定零功率电阻 Rated Zero-Power Resistance $R_N(\Omega)$	$5\pm 20\%$	环境温度 $T_A$ : $25^\circ\text{C} \pm 1^\circ\text{C}$ 测试电压: $1.5\text{V}_{\text{DC}}$ 在恒温 $T_A$ 条件下, 放置1~2 小时后测得阻值 $R_N$ 。 Ambient temp. Range: $25^\circ\text{C} \pm 1^\circ\text{C}(T_A)$ . Testing voltage: $1.5\text{V}_{\text{DC}}$ After placing for 1~2 hours under $T_A$ , the resistance value shall be measured
热耗散系数 $\delta$ (mW/°C) Thermal Dissipation Constant	$\approx 11$	在特定的环境温度下, 热耗散系数( $\delta$ )为热敏电阻电功率消耗 ( $\Delta P$ )与本体温度变化量( $\Delta T$ )的比值。 The thermal dissipation constant( $\delta$ ) could be calculated by the ratio of a change in power dissipation( $\Delta P$ ) of the thermistor to a change in temperature( $\Delta T$ ) of the thermistor at a specified ambient temperature
热时间常数 $\tau$ (s) Thermal Time Constant	$\approx 35$	热时间常数( $\tau$ )为在零功率条件下, 热敏电阻的温度下降到其最初温度与最终温度之差为63.2% 时所需要的时间 The time( $\tau$ ) shall be measured within which the temperature change of NTC thermistor is reached at 63.2% of the ambient temperature change under zero power condition
材料常数 Material Constant B	$2700 \pm 10\%$ $B = T_1 T_2 / (T_2 - T_1) \times \ln(R_1 / R_2)$	$R_1, R_2$ 分别为 $T_1, T_2$ 温度下的零功率电阻 $R_1, R_2$ is zero-power resistance at $T_1, T_2$ $T_1 = 298.15 \text{ K}(25^\circ\text{C})$ $T_2 = 358.15 \text{ K}(85^\circ\text{C})$
最大稳态电流 (A) Max. Steady State Current	无可见损伤 visible mechanical damage. $\Delta R_N / R_N \leq 20\%$ ( $\Delta R =  R_N - R_N' $ )	环境温度: $25^\circ\text{C} \pm 2^\circ\text{C}$ Ambient temp. Range. 测试电流 3A Testing Current

### 7.3 可靠性试验 Reliability Test

可靠性试验(周期性检测项目) Reliability Test				
指标项目 Item	技术要求 Specification	测试条件/方法 Test Conditions & Methods		
温度变化 Temperature change	无可见损伤 No visible mechanical damage. $\Delta R_N / R_N \leq 20\%$ ( $\Delta R =  R_N - R_{N'} $ )	循环 5 次		
		步骤	温度(°C)	时间(min)
		1	Tu±2	30±3
		2	室温	5±3
		3	Tl±2	30±3
		4	室温	5±3
电循环测试 Electrical Cycling Testing	无可见损伤 No visible mechanical damage. $\Delta R_N / R_N \leq 20\%$ ( $\Delta R =  R_N - R_{N'} $ )	环境温度:25°C±2°C. 循环次数: 1,000 次 通/断: 1 分钟/ 5 分钟 测试电流:3.0A 样品置于室温(25±2°C) 4~5 小时后,测量其零功率电阻R <sub>N'</sub> . Ambient temp. Range:25°C±2°C. Cycles: 1,000times On / Off: 1m / 5m Test Current 3.0A After recovering 4~5h under 25±2°C, the rated zero power resistance value R <sub>N'</sub> shall be measured.		
持久性测试 LoadLife ( Endurance ) Testing	无可见损伤 No visible mechanical damage. $\Delta R_N / R_N \leq 20\%$ ( $\Delta R =  R_N - R_{N'} $ )	环境温度:25°C±2°C .样品通过最大工作电流 3.0A , 1,000±24 小时后, 取出置于室温(25±2°C) 4~5 小时后,测量其零功率电阻R <sub>N'</sub> . Ambient temp. Range:25°C±2°C; 3.0A/ 1,000±24h After recovering 4~5 h under 25±2°C, the rated zero power resistance value R <sub>N'</sub> shall be measured.		
稳态湿热 Steady state	无可见损伤, 绝缘电阻绝缘电压符合要求 No visible damage, insulation resistance insulation voltage meets the requirements $\Delta R_N / R_N \leq 20\%$ ( $\Delta R =  R_N - R_{N'} $ )	40±2°C, 93%RH, 1000H		

## 8、电压-电流关系曲线 Graph of Voltage vs. Current

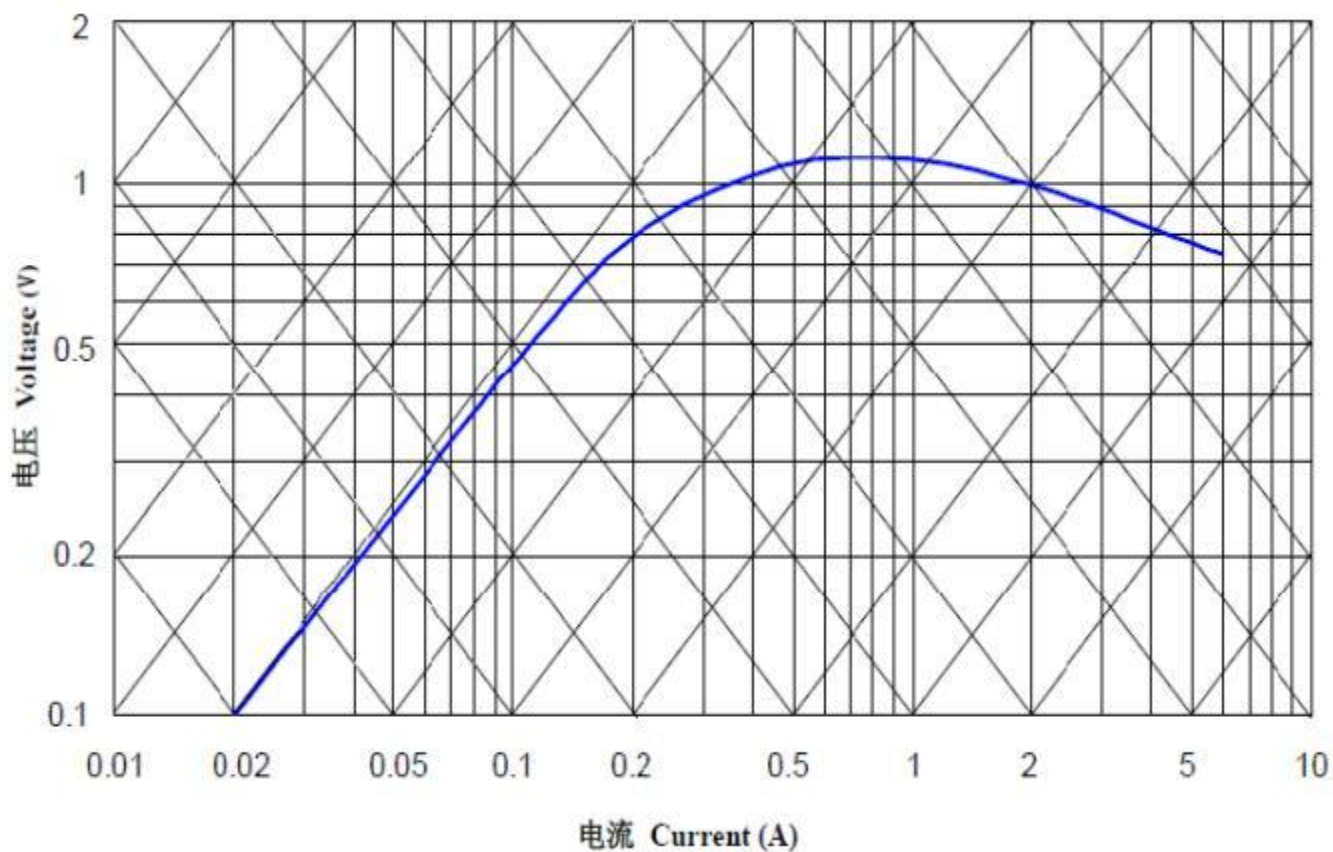

## 9、产品特性曲线 Graph of Characteristics

### 9.1 电阻-温度关系曲线 Graph of Resistance vs. Temperature

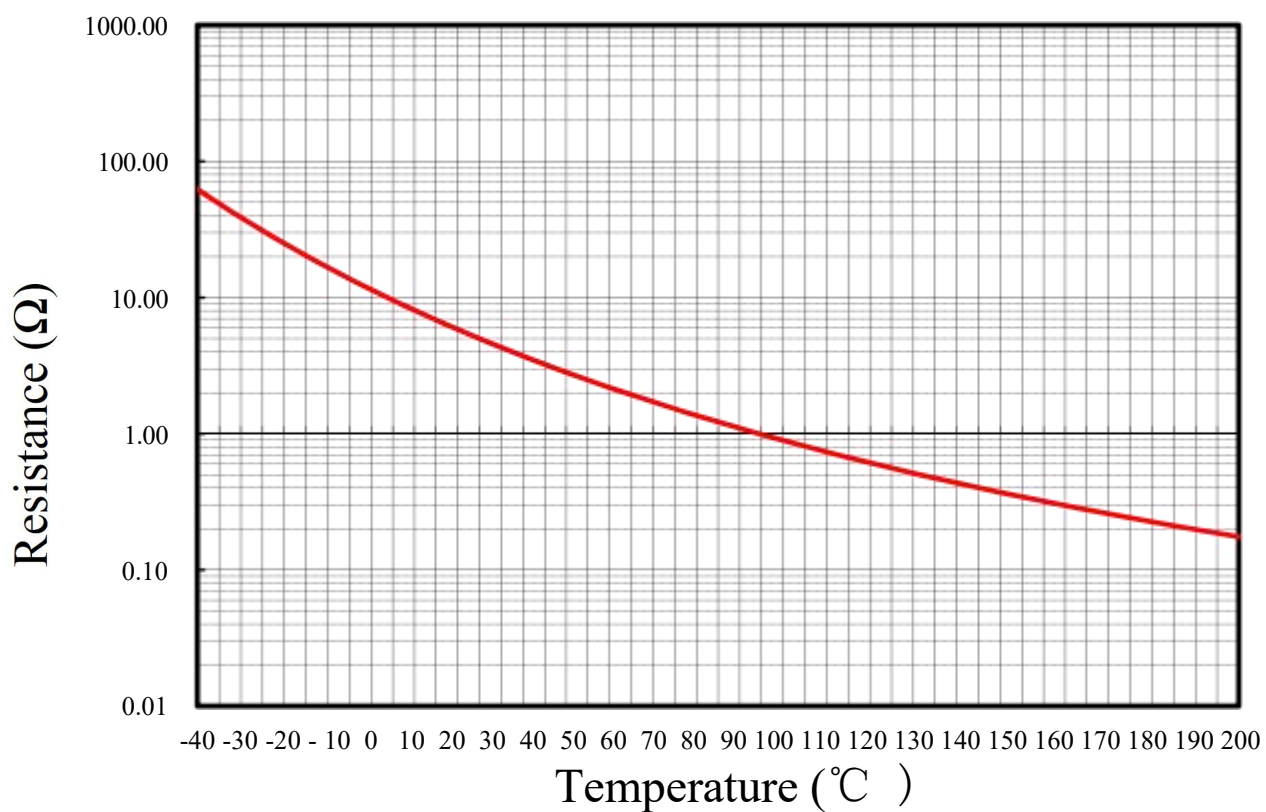

### 9.1.1 R-T chart 阻温特性表

温度 Temp °C	阻值 Resistance Ω			温度 Temp °C	阻值 Resistance Ω		
	下限值 lower limiting value	中心值 Central value	上限值 upper-limit value		下限值 lower limiting value	中心值 Central value	上限值 upper-limit value
-40.0	38.80	62.43	96.44	-19.0	16.40	23.98	33.66
-39.0	37.11	59.42	91.33	-18.0	15.80	23.00	32.15
-38.0	35.51	56.58	86.54	-17.0	15.22	22.07	30.73
-37.0	33.99	53.89	82.03	-16.0	14.67	21.19	29.37
-36.0	32.55	51.36	77.79	-15.0	14.14	20.34	28.09
-35.0	31.18	48.96	73.81	-14.0	13.64	19.54	26.87
-34.0	29.87	46.69	70.06	-13.0	13.15	18.77	25.71
-33.0	28.64	44.55	66.53	-12.0	12.69	18.04	24.61
-32.0	27.46	42.52	63.20	-11.0	12.25	17.34	23.56
-31.0	26.34	40.60	60.07	-10.0	11.83	16.67	22.57
-30.0	25.28	38.78	57.11	-9.0	11.42	16.04	21.63
-29.0	24.26	37.05	54.32	-8.0	11.03	15.43	20.73
-28.0	23.30	35.42	51.70	-7.0	10.66	14.85	19.87
-27.0	22.38	33.87	49.21	-6.0	10.30	14.30	19.06
-26.0	21.50	32.40	46.87	-5.0	9.96	13.77	18.29
-25.0	20.67	31.00	44.65	-4.0	9.63	13.27	17.55
-24.0	19.87	29.68	42.56	-3.0	9.31	12.78	16.85
-23.0	19.11	28.42	40.58	-2.0	9.01	12.32	16.18
-22.0	18.38	27.23	38.70	-1.0	8.71	11.88	15.54
-21.0	17.69	26.09	36.93	0.0	8.43	11.45	14.93
-20.0	17.03	25.01	35.25	1.0	8.16	11.05	14.35



9.1.2 R-T chart 阻温特性表

温度 Temp℃	阻值 Resistance Ω			温度 Temp℃	阻值 Resistance Ω		
	下限值 lower limiting value	中心值 Central value	上限值 upper-limit value		下限值 lower limiting value	中心值 Central value	上限值 upper-limit value
2.0	7.91	10.66	13.80	23.0	4.23	5.32	6.42
3.0	7.66	10.29	13.27	24.0	4.11	5.15	6.20
4.0	7.42	9.93	12.76	25.0	4.00	5.00	6.00
5.0	7.19	9.59	12.28	26.0	3.87	4.85	5.84
6.0	6.97	9.26	11.82	27.0	3.74	4.71	5.68
7.0	6.75	8.95	11.38	28.0	3.62	4.57	5.53
8.0	6.55	8.65	10.96	29.0	3.51	4.44	5.39
9.0	6.35	8.36	10.56	30.0	3.39	4.31	5.25
10.0	6.16	8.08	10.17	31.0	3.29	4.18	5.11
11.0	5.98	7.81	9.80	32.0	3.18	4.06	4.98
12.0	5.80	7.56	9.45	33.0	3.08	3.95	4.85
13.0	5.63	7.31	9.11	34.0	2.99	3.83	4.73
14.0	5.47	7.07	8.79	35.0	2.90	3.73	4.61
15.0	5.31	6.85	8.48	36.0	2.81	3.62	4.49
16.0	5.16	6.63	8.18	37.0	2.72	3.52	4.38
17.0	5.01	6.42	7.90	38.0	2.64	3.42	4.27
18.0	4.87	6.22	7.62	39.0	2.56	3.33	4.16
19.0	4.73	6.02	7.36	40.0	2.48	3.24	4.06
20.0	4.60	5.84	7.11	41.0	2.41	3.15	3.96
21.0	4.47	5.66	6.87	42.0	2.34	3.07	3.87
22.0	4.35	5.48	6.64	43.0	2.27	2.99	3.77

9.1.3 R-T chart 阻温特性表

温度 Temp℃	阻值 Resistance Ω			温度 Temp℃	阻值 Resistance Ω		
	下限值 lower limiting value	中心值 Central value	上限值 upper-limit value		下限值 lower limiting value	中心值 Central value	上限值 upper-limit value
44.0	2.20	2.91	3.68	65.0	1.23	1.71	2.29
45.0	2.14	2.83	3.59	66.0	1.20	1.67	2.24
46.0	2.08	2.76	3.51	67.0	1.17	1.63	2.19
47.0	2.02	2.68	3.43	68.0	1.14	1.60	2.15
48.0	1.96	2.61	3.35	69.0	1.11	1.56	2.10
49.0	1.90	2.55	3.27	70.0	1.08	1.52	2.06
50.0	1.85	2.48	3.19	71.0	1.06	1.49	2.02
51.0	1.80	2.42	3.12	72.0	1.03	1.46	1.98
52.0	1.75	2.36	3.05	73.0	1.00	1.42	1.94
53.0	1.70	2.30	2.98	74.0	0.98	1.39	1.90
54.0	1.65	2.24	2.91	75.0	0.96	1.36	1.86
55.0	1.61	2.18	2.85	76.0	0.93	1.33	1.82
56.0	1.57	2.13	2.78	77.0	0.91	1.30	1.79
57.0	1.52	2.08	2.72	78.0	0.89	1.27	1.75
58.0	1.48	2.03	2.66	79.0	0.87	1.25	1.72
59.0	1.44	1.98	2.61	80.0	0.85	1.22	1.69
60.0	1.40	1.93	2.55	81.0	0.83	1.19	1.65
61.0	1.37	1.88	2.49	82.0	0.81	1.17	1.62
62.0	1.33	1.84	2.44	83.0	0.79	1.14	1.59
63.0	1.30	1.80	2.39	84.0	0.77	1.12	1.56
64.0	1.26	1.75	2.34	85.0	1.23	1.71	2.29

**9.1.4 R-T chart 阻温特性表**

温度 Temp℃	阻值 Resistance Ω			温度 Temp℃	阻值 Resistance Ω		
	下限值 lower limiting value	中心值 Central value	上限值 upper-limit value		下限值 lower limiting value	中心值 Central value	上限值 upper-limit value
86.0	0.75	1.10	1.53	108.0	0.46	0.70	1.02
87.0	0.74	1.07	1.50	109.0	0.45	0.68	1.00
88.0	0.72	1.05	1.48	110.0	0.44	0.67	0.98
89.0	0.70	1.03	1.45	111.0	0.43	0.66	0.97
90.0	0.69	1.01	1.42	112.0	0.42	0.65	0.95
91.0	0.67	0.99	1.40	113.0	0.41	0.63	0.94
92.0	0.66	0.97	1.37	114.0	0.41	0.62	0.92
93.0	0.64	0.95	1.34	115.0	0.40	0.61	0.91
94.0	0.63	0.93	1.32	116.0	0.39	0.60	0.89
95.0	0.62	0.91	1.30	117.0	0.38	0.59	0.88
96.0	0.60	0.89	1.27	118.0	0.37	0.58	0.86
97.0	0.59	0.88	1.25	119.0	0.37	0.57	0.85
98.0	0.58	0.86	1.23	120.0	0.36	0.56	0.84
99.0	0.56	0.84	1.21	121.0	0.35	0.55	0.82
100.0	0.55	0.83	1.19	122.0	0.35	0.54	0.81
101.0	0.54	0.81	1.17	123.0	0.34	0.53	0.80
102.0	0.53	0.79	1.15	124.0	0.33	0.52	0.79
103.0	0.52	0.78	1.13	125.0	0.33	0.51	0.77
104.0	0.51	0.76	1.11	126.0	0.32	0.51	0.76
105.0	0.50	0.75	1.09	127.0	0.32	0.50	0.75
106.0	0.49	0.74	1.07	128.0	0.31	0.49	0.74
107.0	0.48	0.72	1.05	129.0	0.30	0.48	0.73

9.1.5 R-T chart 阻温特性表

温度 Temp℃	阻值 Resistance Ω			温度 Temp℃	阻值 Resistance Ω		
	下限值 lower limiting value	中心值 Central value	上限值 upper-limit value		下限值 lower limiting value	中心值 Central value	上限值 upper-limit value
130.0	0.30	0.47	0.72	153.0	0.20	0.33	0.52
131.0	0.29	0.46	0.71	154.0	0.20	0.32	0.51
132.0	0.29	0.46	0.70	155.0	0.19	0.32	0.51
133.0	0.28	0.45	0.69	156.0	0.19	0.32	0.50
134.0	0.28	0.44	0.68	157.0	0.19	0.31	0.49
135.0	0.27	0.44	0.67	158.0	0.19	0.31	0.49
136.0	0.27	0.43	0.66	159.0	0.18	0.30	0.48
137.0	0.26	0.42	0.65	160.0	0.18	0.30	0.47
138.0	0.26	0.42	0.64	161.0	0.18	0.29	0.47
139.0	0.25	0.41	0.63	162.0	0.17	0.29	0.46
140.0	0.25	0.40	0.62	163.0	0.17	0.28	0.46
141.0	0.25	0.40	0.61	164.0	0.17	0.28	0.45
142.0	0.24	0.39	0.60	165.0	0.17	0.28	0.44
143.0	0.24	0.38	0.59	166.0	0.16	0.27	0.44
144.0	0.23	0.38	0.59	167.0	0.16	0.27	0.43
145.0	0.23	0.37	0.58	168.0	0.16	0.27	0.43
146.0	0.23	0.37	0.57	169.0	0.16	0.26	0.42
147.0	0.22	0.36	0.56	170.0	0.15	0.26	0.42
148.0	0.22	0.36	0.56	171.0	0.15	0.25	0.41
149.0	0.21	0.35	0.55	172.0	0.15	0.25	0.41
150.0	0.21	0.34	0.54	173.0	0.15	0.25	0.40
151.0	0.21	0.34	0.53	174.0	0.14	0.24	0.40
152.0	0.20	0.33	0.53	175.0	0.14	0.24	0.39

## 10、产品标志说明

### 中性标志 The neutral marks

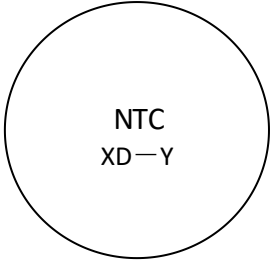
	NTC	负温度系数热敏电阻器 NTC thermistor
	X	额定零功率电阻值 Rated ZeroPower Resistance
	D	圆片型 Disk-Type
	Y	最大芯片直径 Max diameter of disk (mm)

以上所有类型标志统称圆片型，生产以中性标志为主，如有特殊要求请与我们的销售人员联系，产品规格与数据若有变更，恕不另行通知



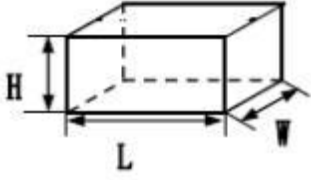
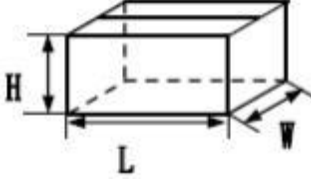

All of the above types of marks round, mainly in the production of neutral markers, if you have special request, please contact our sales staff, for product specification and data are subject to change without notice

## 11、包装 Packing

### 11.1 散装数量 IN BULK QUANTITY

产品包装 Product packaging	内盒 Inside the box	外箱 carton
散装 In Bulk	 260*210*55 (L*W*H)	 430*280*180 (L*W*H)
	产品数量(只) product quantity(pieces)	产品数量(只) product quantity(pieces)

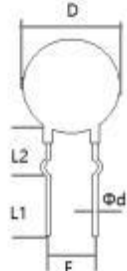
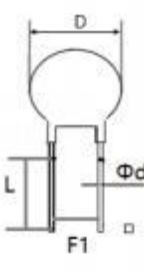
#### 11.1.1 散装式样 BULK STYLE

内弯脚 (I Type)	切短脚 (C Type)	直线脚 (S Type)	外弯脚 (O Type)	侧弯脚 (Y Type)	厚度 (T)
					

#### 11.1.2 散装包装式样 Bulk/Packing Style

##### ①、常规产品包装 Normal product packaging

规格 Dimension	一袋 Bag	内盒 Inside the box	外箱 carton
NTC□D-5	1000 pcs	3000 pcs	18000 pcs
NTC□D-7	1000 pcs	3000 pcs	18000 pcs
NTC□D-9	500 pcs	2000 pcs	12000 pcs
NTC□D-11	500 pcs	1500 pcs	9000 pcs
NTC□D-13	250 pcs	1000 pcs	6000 pcs
NTC□D-15	250 pcs	1000 pcs	6000 pcs
NTC□D-20	100 pcs	400 pcs	2400 pcs

## ②、切脚产品包装 Cut the feet product packaging

规格 Dimension	一袋 Bag	内盒 Inside the box	外箱 carton
NTC□D-5	1000 pcs	8000 pcs	48000 pcs
NTC□D-7	1000 pcs	5000 pcs	30000 pcs
NTC□D-9	1000 pcs	4000 pcs	24000 pcs
NTC□D-11	1000 pcs	3000 pcs	18000 pcs
NTC□D-13	500 pcs	2000 pcs	12000 pcs
NTC□D-15	500 pcs	1000 pcs	6000 pcs
NTC□D-20	100 pcs	400 pcs	2400 pcs

### 11.2 编带数量 Tape number

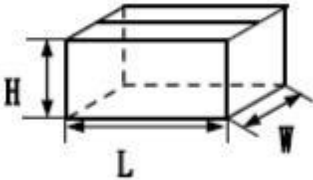
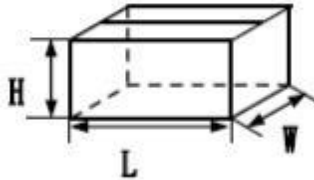
产品包装 Product ackaging	内盒 Inside the box		外箱 carton	
编带 Taping	 335*265*45 (L*W*H)		 540*360*295 (L*W*H)	
	产品数量(只) product quantity(pieces)	500/ 1000/ 1500	产品数量(只) product quantity(pieces)	6000/ 12000/ 18000

### 11.3 编带包装式样 Packing style

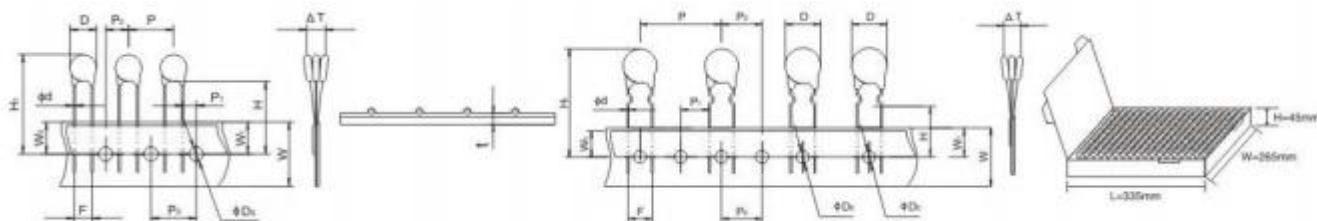

## 11.4 编带尺寸 Tape size

名称 Description	符号 Symbol	外观 Exterior	产品直径 Dimension					
			ø5	ø7	ø9-ø11	ø13	ø15	ø20
编带间距 Taping pitch	P ±1	直脚/弯脚	12.7	12.7	12.7/25.4 /15	15/25.4	15/30	25.4
输送孔间距 Feed hole pitch	P0 ±1	直脚/弯脚	12.7	12.7	12.7/15	12.7/15	12.7/15	12.7
对输送孔的偏 Feed hole off alignment	P1 ±0.7	直脚/弯脚	3.75	3.75	3.75/8.95	3.75/8.95	3.75/8.95	7.7
	P2 ±1.3	直脚/弯脚	6.35	6.35	6.35/7.5/ 12.7	7.5/12.7	7.5/12.7	12.7
底部高度 Bottom height	H ±1.0	直脚	19	19	19	19	19	19
		弯脚	18	18	18	18	18	18
顶部高度 Top height	H1 max	直脚/弯脚	29.0	32.0	36.0	40	40	/
载带宽度 Carrier tape width	W ±1.0	直脚/弯脚	18	18	18	18	18	18
胶带宽度 Adhesive tape width	W0 ±0.5	直脚/弯脚	10.0	10.0	10.0	10.0	10.0	12.0
对输送孔的高度偏移 Feed hole height off alignment	W1 ±0.5	直脚/弯脚	9.0	9.0	9.0	9.0	9.0	9.0
输送孔直径 Feed hole diameter	øD0 ±0.3	直脚/弯脚	4.0	4.0	4.0	4.0	4.0	4.0
本体直径 Body diameter	D max	直脚/弯脚	7.0	9.0	11.0/13.0	15.5	17.5	22.5
引线直径 Wire lead diameter	ød ±0.05	直脚/弯脚	ø0.55	ø0.55	ø0.55/ ø0.75	ø0.75	ø0.75/ ø0.95	ø1.0
产品在胶带上偏差 Deviation across tape	△T max	直脚/弯脚	2.0	2.0	2.0	2.0	2.0	2.0
编带总厚度 Overall tape thickness	t ±0.2	直脚/弯脚	0.7	0.7	0.7	0.7	0.7	0.7
引线间距 Lead spacing	F ±1.0	直脚/弯脚	5.0	5.0	7.5/5.0	7.5	7.5	10.0



## 12 NTC 热敏电阻注意事项 Matters Needing Attention For NTC Thermistors

**请遵循以下事项，否则可能会造成 NTC 热敏电阻损坏，使用设备损伤或引起误动作等后果**

**Please follow the rules listed below when using NTC thermistors. Otherwise, you may cause damage to the NTC thermistor and relevant equipment or hurt yourself.**

①、请勿在使用温度范围以外使用，请勿施加超出使用温度范围上下限的急剧温度变化。

Do not use the thermistor under temperature beyond the operating temperature range.

Do not apply rapid temperature changes which exceed the upper and lower limits of the operating temperature range.

②、请在额定功率条件下使用 NTC 热敏电阻。各规格最大额定功率为  $\Phi 5-0.7W$   $\Phi 7-1.2W$

$\Phi 9-1.9W$   $\Phi 11-2.3W$   $\Phi 13-3W$   $\Phi 15-3.5W$   $\Phi 20-4W$

Please use the NTC thermistor under the standard power. The maximum standard powers of each specification are :  $\Phi 5-0.7W$   $\Phi 7-1.2W$   $\Phi 9-1.9W$   $\Phi 11-2.3W$   $\Phi 13-3W$   $\Phi 15-3.5W$   $\Phi 20-4W$

③、在高湿高温环境下使用护套型 NTC 热敏电阻时应采取仅使护套封闭部分暴露于环境(水中 湿气)中，而护套开口部分不会直接接触到水及蒸汽的设计

When using the sheath type NTC thermistors in the high humidity and high temperature environment, the sealing part of the sheath should be exposed to the environment (moisture or water) while the opening part of the sheath is not directly exposed to the water or steam.

④、配线时应确保导线端部(含连接器)不会深入水. 蒸汽. 电解质液等否则会造成接触不良。

When wiring, the ends of the wire (including connectors) should not be posited deeply inside water, steam, electrolyte solution, etc. Otherwise, it will result in poor contact.

⑤、请勿在腐蚀性气体的环境( $Cl_2$  .  $NH_3$  .  $SO_x$ .  $NO_x$ ) 以及会接触到电解质液. 盐水. 酸. 碱. 有机溶剂的场所中使用。

Please do not expose the thermistor to corrosive gas ( $NH_3$ ,  $SO_x$ ,  $NO_x$ ,  $Cl_2$ ) or any saline solution, acid solution, alkaline solution and electrolyte solution.

⑥、请勿过度拉伸及弯曲导线，请勿施加过度的振动. 冲击及压力

Do not over stretch or bend the wire. Please do not apply excessive vibration, pressure and impact on the thermistor.

⑦、金属腐蚀可能会造成设备功能故障，故在选择材质时应确保金属护套型及螺钉紧固型 NTC 热敏电阻与安装的金属件之间不会产生接触的电位差。

To avoid equipment faults caused by metal corrosion, please choose the right material to make sure there is no potential difference at the contact point between metal sheath type or screw fastening type NTC thermistor and the metal components.

⑧、功率型 NTC 周围应避免安装发热和易燃元件，建议选用弯脚上部引线较高的产品，使 NTC 热敏电阻在线路板上高出其它元件，以免发热影响其它元件正常工作。

Do not install any flammable component or component generating heat surrounding the power type NTC.

Our recommendation is to avoid the negative effect brought by the heat from the NTC, please use products with higher lead wire on the bending feet to make the NTC thermistor on the circuit board higher than the other components.

⑨、NTC 热敏电阻是按不同的功能用途分别进行设计的, 如有疑问可与我司联络。

NTC thermistors have specific designs for different functions. Feel free to contact us if you have any question.

## X-ON Electronics

Largest Supplier of Electrical and Electronic Components

*Click to view similar products for [NTC \(Negative Temperature Coefficient\) Thermistors category:](#)*

*Click to view products by [VDR manufacturer:](#)*

Other Similar products are found below :

[118-253FAJ-P01](#) [121-202EAC-P01](#) [123-802EAJ-P01](#) [128-105NDP-Q02](#) [B57234S330M](#) [NTCLE410E3103F](#) [199-303KAF-A02](#) [30054-4](#)  
[M09N038F](#) [B57401V2103H062](#) [500-52AA04-101](#) [526-31AA19-104](#) [526-31AN12-202](#) [103AT-5-1P-FT](#) [10K3A542I](#) [111-802EAJ-901](#) [112-](#)  
[103FAG-H02](#) [112-104KAG-B01](#) [111-182CAG-H01](#) [112-103FAF-H01](#) [112-104KBF-F01](#) [526-31AA79-102](#) [B57621C5472J62](#) [44015RC](#)  
[194303KEVA01](#) [B57359V2224J260](#) [B57621C5472K062](#) [135-105QAF-J02](#) [B57230V2103H260](#) [NTCS0603E3333FHT](#) [118-802EAJ-P01](#)  
[121-103FAC-Q02](#) [521-53AW02-104](#) [199-202FAD-A02](#) [CL109R4120](#) [GA100K6D234](#) [USUR1000-502G-06](#) [GA10K3MR1I](#) [USUR1000-](#)  
[203G-06](#) [NTCS0603E3333HHT](#) [GA1K7CG3](#) [NXFT15WB473FEAB030](#) [GA10K3A542I](#) [NTCLE213E3103JHT1](#) [A1504AS26P2A](#)  
[PANR103338-490](#) [NTCALUG02A502FA](#) [JSNA104F425FABXG](#) [JSNA103F345FABXG](#) [JSNA473F405FABXG](#)