

VDR-3225 SMT Disc Varistors

FEATURES

- Improved component design in a compact case
- High surge current capability
- Superior performance at high temperature
- SMD mountable disk varistors, suitable for lead-free reflow / wave soldering

APPLICATIONS

- Power supplies for telecommunication systems
- Protection for LED circuits
- Protection for consumer, industrial equipment
- Protection for automotive electronics

APPLICABLE STANDARDS

- UL1449 TYPE5 E525940
- TUV B115439 001 IEC61051-1, -2, -2-2, IEC60950-1Annex Q IEC 62368-1:2018/G.8.1
- IEC61000-4-5
- GB/T10193-1997 GB/T10194-1997/GB8898 GB4943.1 CQCNO:22001333055

TYPE CODE DESIGNATION

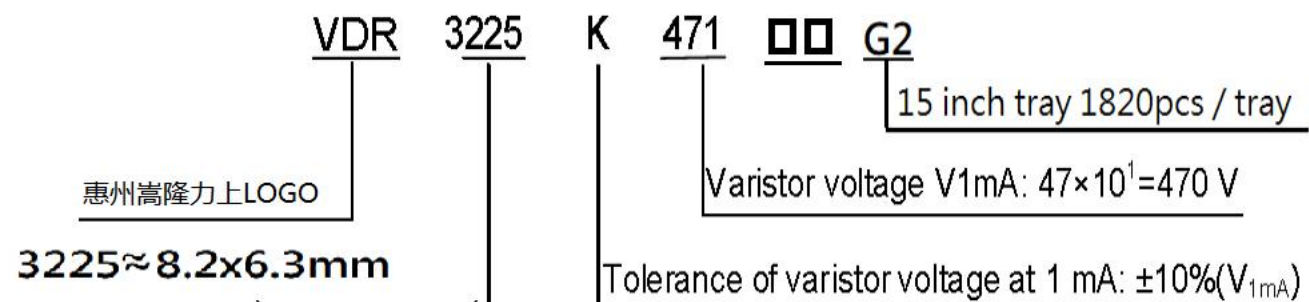

General parameters

Parameter name	Parameter value	UNIT
working temperature	-55 — +125	°C
Storage temperature	-55 — +125	°C
Withstand voltage	≥2.5	KV _{RMS}
Insulation resistance	≥100	MΩ

Structure and size

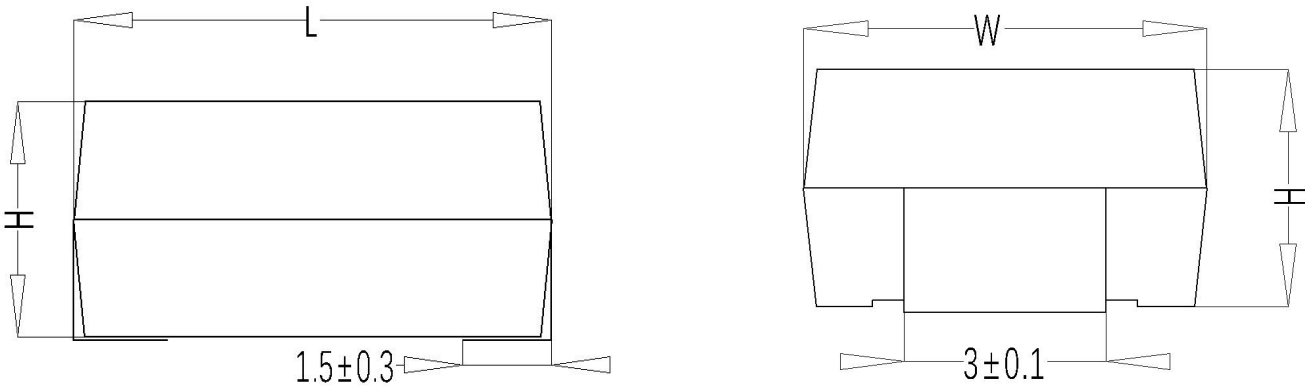

(UNIT:mm)

size	Varistor voltage range (V)	L	W	H
3225	V _{1ma} =201—681	8.2±0.3	6.3±0.3	4.3±0.3
	V _{1ma} =751—821			5.2±0.3

Welding size

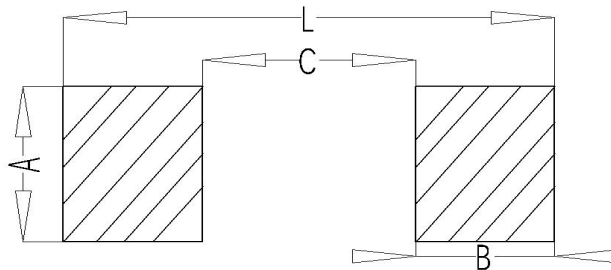

(UNIT:mm)

SIZE	A	B	C	L
3225	3.5	2.8	4.5	10.1

Electrical characteristics (Standard)

Model	Varistor voltage (@1mA DC)	Maximum Clamping Voltage		Maximum Allowable Voltage (8/20 μ s)		Max Surge 8/20 μ s	Energy (10/1000 μ s)	Rated Powe	Typical Capacitance (Reference) @1KHZ
	V _{1mA} (V)	V _{AC} (V)	V _{DC} (V)	V _p (V)	I _p (A)	I max (A)	W max (J)	P (W)	C(pF)
3225K201	200(180-220)	130	170	340	10	1200	15.0	0.25	200
3225K221	220(198-242)	140	180	360	10	1200	18.0	0.25	180
3225K241	240(216-264)	150	200	395	10	1200	18.5	0.25	170
3225K271	270(243-297)	175	225	455	10	1200	21.0	0.25	150
3225K361	360(324-396)	230	300	595	10	1200	23.0	0.25	115
3225K391	390(351-429)	250	320	650	10	1200	25.0	0.25	105
3225K431	430(387-473)	275	350	710	10	1200	29.0	0.25	95
3225K471	470(423-517)	300	385	775	10	1200	30.0	0.25	90
3225K511	510(459-561)	320	410	845	10	1200	33.0	0.25	85
3225K561	560(504-616)	350	450	930	10	1200	33.0	0.25	80
3225K621	620(558-682)	395	510	1020	10	1200	35.0	0.25	78
3225K681	680(612-748)	420	560	1120	10	1200	35.0	0.25	75
3225K751	750(675-825)	460	615	1235	10	1200	50.0	0.25	70
3225K781	780(702-858)	485	640	1290	10	1200	51.0	0.25	65
3225K821	820(738-902)	510	670	1355	10	1200	52.0	0.25	60



Electrical characteristics (High energy)

Model	Varistor voltage (@1mA DC)	Maximum Clamping Voltage		Maximum Allowable Voltage (8/20 μ s)		Max Surge 8/20 μ s	Energy (10/1000 μ s)	Rated Power	Typical Capacitance (Reference) @1KHZ
	V _{1mA} (V)	V _{AC} (V)	V _{DC} (V)	V _p (V)	I _p (A)	I max (A)	W max (J)	P (W)	C(pF)
3225K201-H	200(180-220)	130	170	340	10	1750	17	0.25	200
3225K221-H	220(198-242)	140	180	360	10	1750	19	0.25	180
3225K241-H	240(216-264)	150	200	395	10	1750	21	0.25	170
3225K271-H	270(243-297)	175	225	455	10	1750	24	0.25	150
3225K361-H	360(324-396)	230	300	595	10	1750	26	0.25	115
3225K391-H	390(351-429)	250	320	650	10	1750	28	0.25	105
3225K431-H	430(387-473)	275	350	710	10	1750	32	0.25	95
3225K471-H	470(423-517)	300	385	775	10	1750	35	0.25	90
3225K511-H	510(459-561)	320	410	845	10	1750	40	0.25	85
3225K561-H	560(504-616)	350	450	930	10	1750	42	0.25	80
3225K621-H	620(558-682)	395	510	1020	10	1750	45	0.25	78
3225K681-H	680(612-748)	420	560	1120	10	1750	49	0.25	75
3225K751-H	750(675-825)	460	615	1235	10	1750	55	0.25	70
3225K781-H	780(702-858)	485	640	1290	10	1750	60	0.25	65
3225K821-H	820(738-902)	510	670	1355	10	1750	67	0.25	60

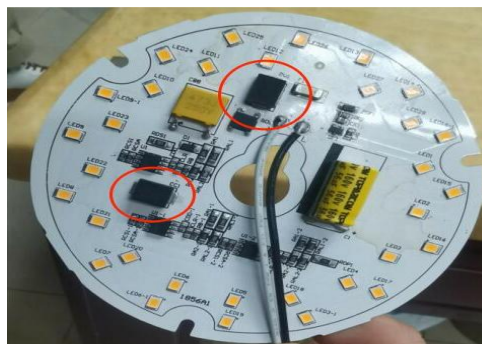

Electrical characteristics (Combined wave)

Model	Varistor voltage (@1mA DC)	Maximum Clamping Voltage		Maximum Allowable Voltage (8/20 μ s)		Surge 2KV/1KA 1.2/50+8/20 μ s (times)	Energy (10/1000 μ s)	Rated Powe	Typical Capacitance (Reference) @1KHZ
	V _{1mA} (V)	V _{AC} (V)	V _{DC} (V)	V _p (V)	I _p (A)	I max1750A 8/2 μ s(1time)	W max (J)	P (W)	C(pF)
3225K201-BC	200(180-220)	130	170	340	10	40	17.0	0.25	200
3225K221-BC	220(198-242)	140	180	360	10	40	19.0	0.25	180
3225K241-BC	240(216-264)	150	200	395	10	40	21.0	0.25	170
3225K271-BC	270(243-297)	175	225	455	10	40	21.0	0.25	150
3225K361-BC	360(324-396)	230	300	595	10	40	35.0	0.25	115
3225K391-BC	390(351-429)	250	320	650	10	40	39.0	0.25	105
3225K431-BC	430(387-473)	275	350	710	10	40	40.0	0.25	95
3225K471-BC	470(423-517)	300	385	775	10	40	42.0	0.25	90
3225K511-BC	510(459-561)	320	410	845	10	40	45.0	0.25	85
3225K561-BC	560(504-616)	350	450	930	10	40	49.0	0.25	80
3225K621-BC	620(558-682)	395	510	1020	10	40	55.0	0.25	78
3225K681-BC	680(612-748)	420	560	1120	10	40	60.0	0.25	75
3225K751-BC	750(675-825)	460	615	1235	10	40	67.0	0.25	70
3225K781-BC	780(702-858)	485	640	1290	10	40	67.0	0.25	65
3225K821-BC	820(738-902)	510	670	1355	10	40	80.0	0.25	60

SOLDERING GUIDELINES

The usage of mild, non-activated fluxes for soldering is recommended, as well as proper cleaning of the PCB. The components are suitable for reflow soldering per JEDEC J-STD-020C.

- Wave soldering

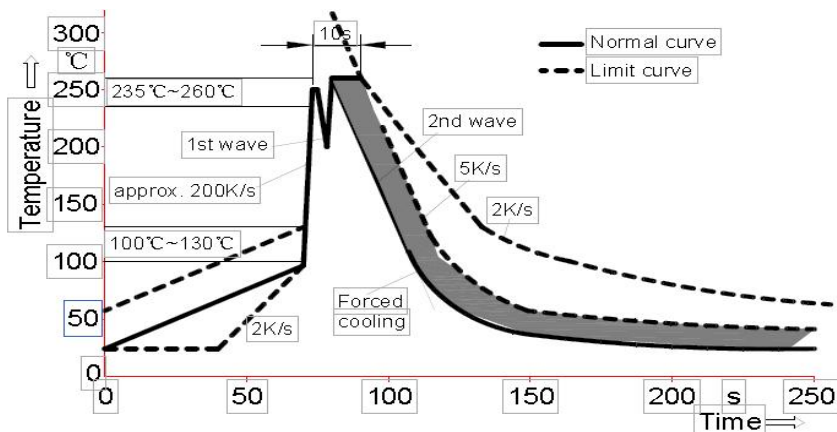

Temperature characteristics at component terminal with dual-wave soldering

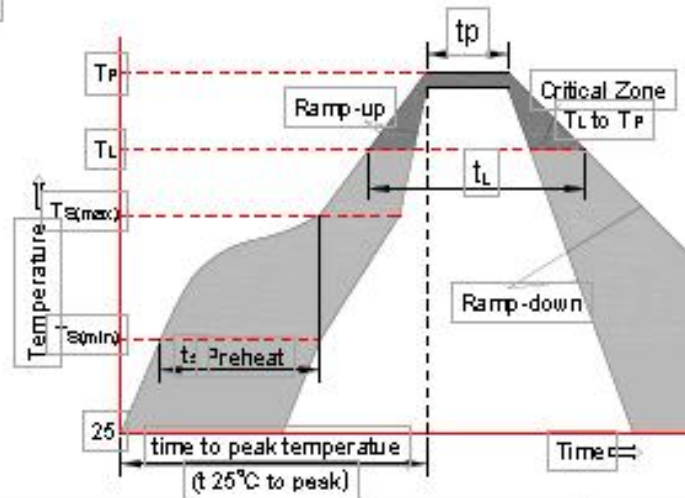
- Reflow soldering

Profile feature		Sn-Pb assembly	Pb-Free assembly
Average ramp-up rate ($T_{s(max)}$ to T_p)		3°C/sec. Max	3°C/sec. Max
Preheat	-Temperature min. ($T_{s(min)}$)	+100°C	+150°C
	-Temperature max. ($T_{s(max)}$)	+150°C	+200°C
	-Time ($t_{s(min)}$ to $t_{s(max)}$)	60-120 secs.	60-180 secs.
$T_{s(max)}$ to T_L - Ramp-up Rate		3°C/sec. Max	3°C/sec. Max
Time maintained above	-Temperature min. (T_L)	+183°C	+217°C
	-Time (t_L)	60-150 secs.	60-150 secs.
Peak classification temperature (T_p)		+220°C to +240°C	+240°C to +260°C
Time within 5°C of actual peak temperature (t_p)		10 secs. to 30 secs.	20 secs. to 40 secs.
Ramp-down rate		6°C/sec. max.	6°C/sec. max.
Time 25°C to peak temperature		6 min. max.	8 min. max.

Notes: All temperature refer to topside of the package, measured on the package body surface

Maximum number of reflow cycles: 3

STORAGE CONDITION

- As far as possible, the components should be employed within 24 months after delivery from Kangtai Semiconductor.
- They should be left in their original packing to avoid soldering problems due to oxidized contacts.
- Storage temperature: - 25 up to + 45°C.
- Relative humidity: < 75 % annual average, < 95 % on max. 30 days in a year.



V/I CHARACTERISTICS V-I

VDR 3225K201 – 3225K471(H/BC)

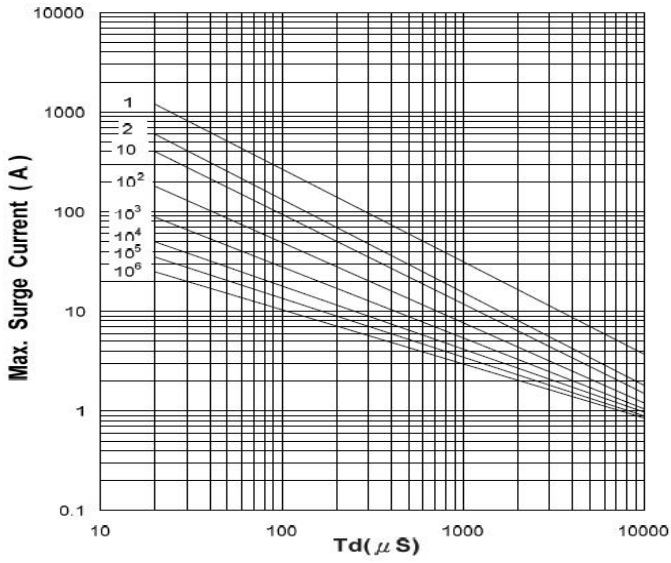

VDR 3225K511 – 3225K821(H/BC)

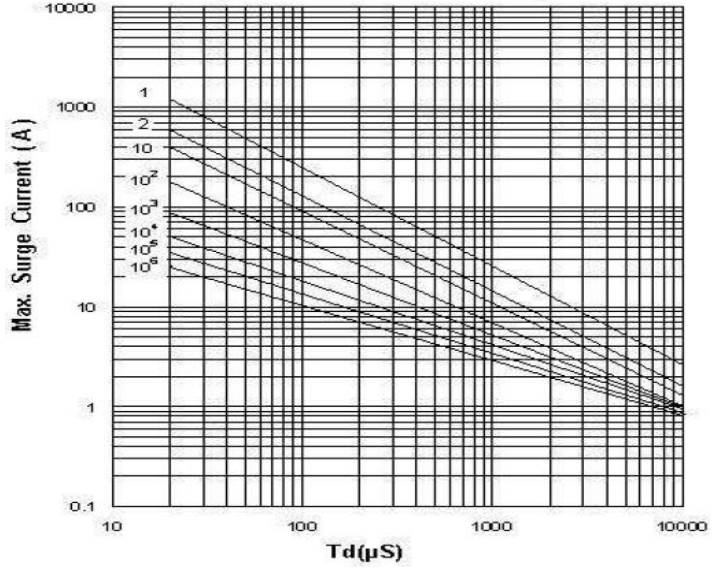

VDR 3225K201 – 3225K471(H/BC)

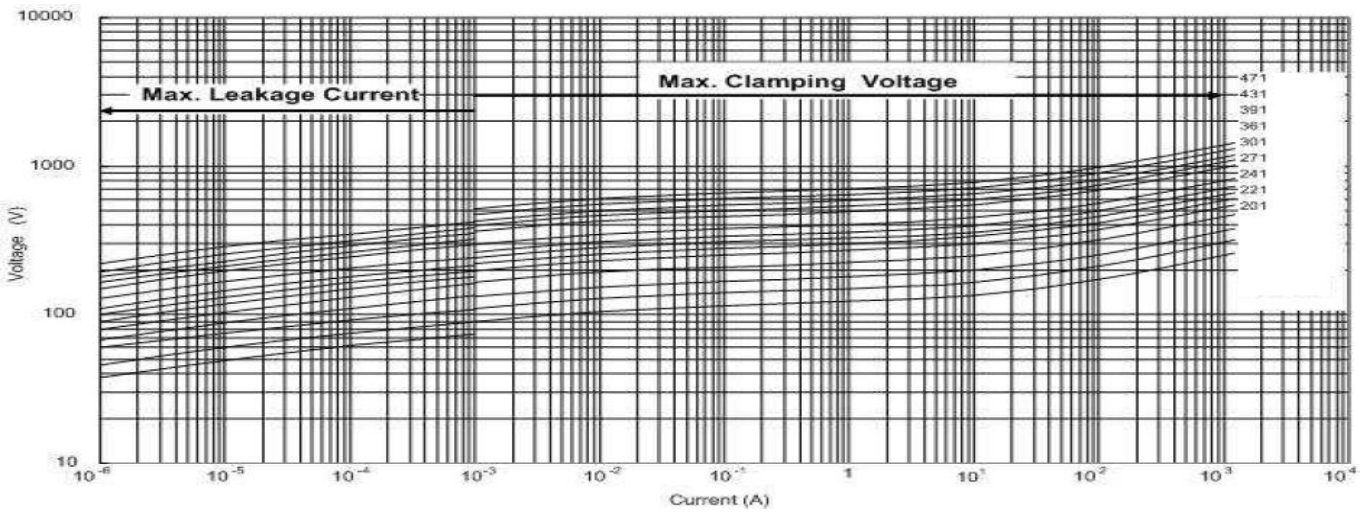

VDR-3225K511 – 3225K751(H/BC)

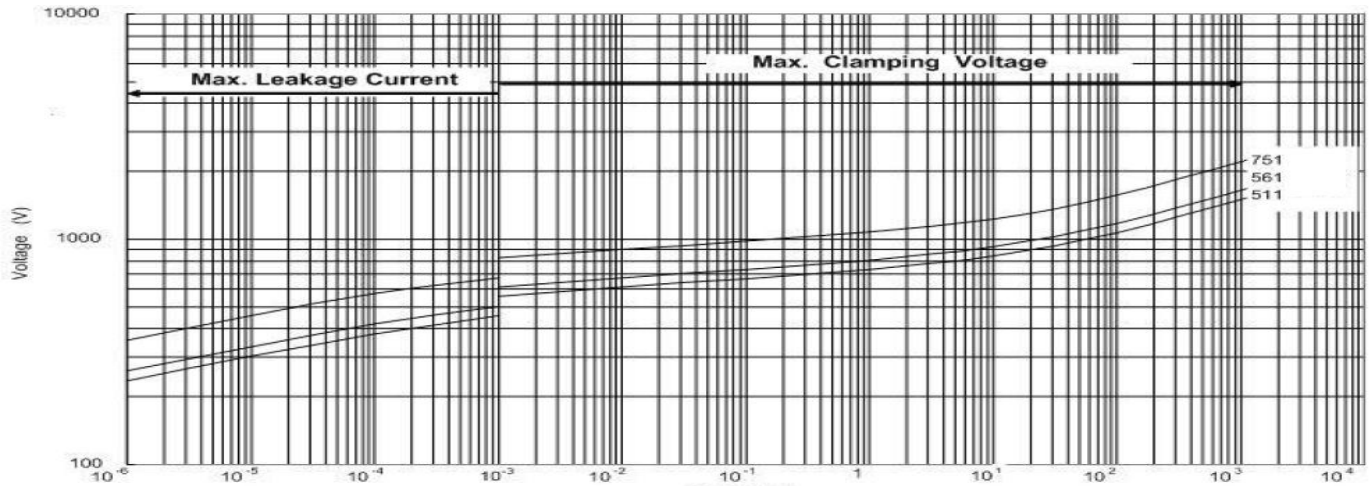

Packing

Tape packing method description 16mm tape size

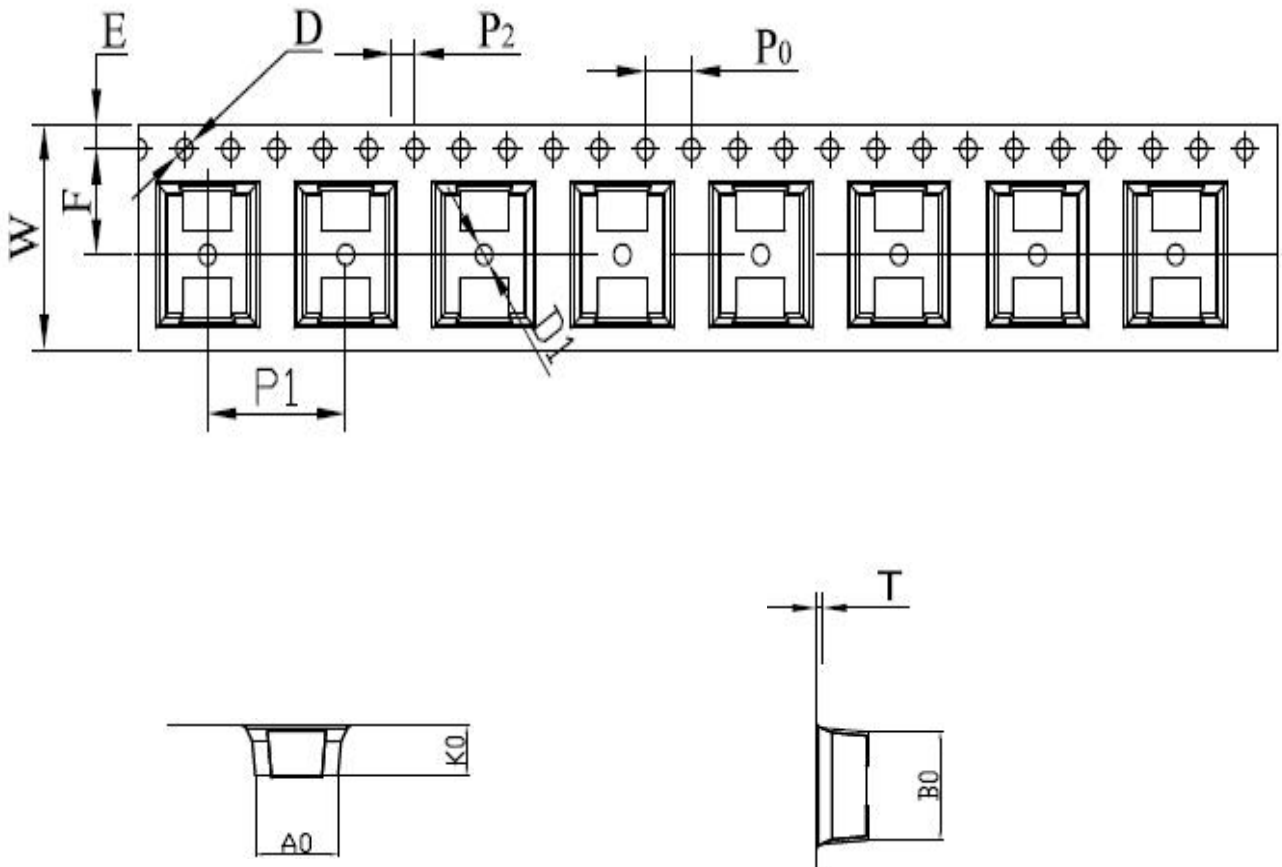

symbol	AO	BO	KO	PO	P1	P2	长度/盘
Spec	6.60±0.1	8.70±0.1	4.50±0.1	4.00±0.10	12.0±0.10	2.00±0.10	24000mm
symbol	W	T	E	F	DO	D1	元件/盘
Spec	16.0±0.3	0.40±0.05	1.75±0.10	7.5±0.1	1.50 ^{+0.1} ₋₀	1.50±0.10	1820 pcs

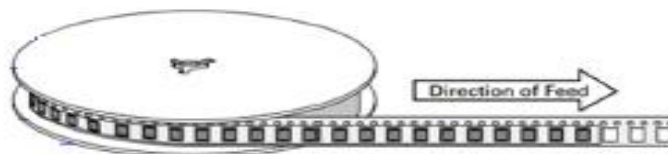

15 inch rubber disc size

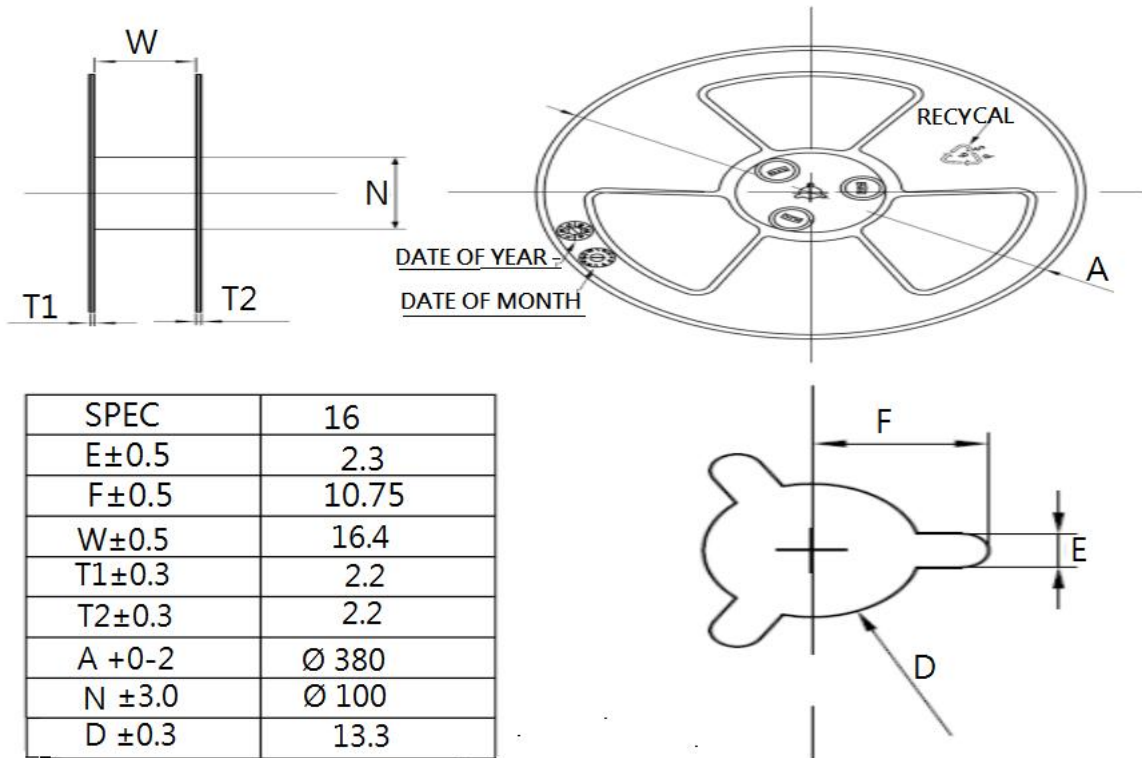

Packing carton

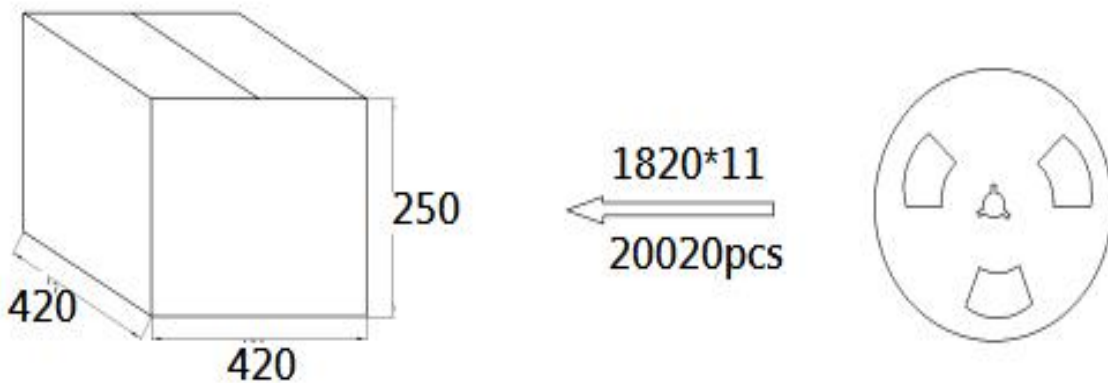

X-ON Electronics

Largest Supplier of Electrical and Electronic Components

Click to view similar products for [Varistors](#) category:

Click to view products by [VDR](#) manufacturer:

Other Similar products are found below :

[R71ZOV151HC](#) [B72205S271K111](#) [B72214S110K151](#) [B72214S251K151](#) [B72540E250K62](#) [NTE1V020](#) [NTE1V130](#) [25FN511K](#)
[S10K11G5S5](#) [ERZ-C14DK361U](#) [ERZ-C20DK221U](#) [ERZ-C32CK201B](#) [207869-1](#) [AS-13](#) [B72214S200K551](#) [B72280B112K1](#) [B72540E](#)
[350K 62](#) [B72590D360A60](#) [B72650M301K93](#) [B72670M1140K72](#) [TVZ18EC271KBS](#) [TVZ20EB911KBS](#) [TVZ25D201KBS](#) [TVZ25D241KBS](#)
[VDRH20X230BSE](#) [VZ07D220KBS](#) [VZ40D241KQ-N](#) [VZ40D241K](#) [VZ25D511KBS-N](#) [VZ20E511KBSX](#) [VZ20E221KBSX](#)
[VZ10D471KBS-N](#) [ERZ-V20R221](#) [20A9FN241K](#) [B72205S350K211](#) [B72214S110K551](#) [B72510E140K62](#) [B72650M350K72](#)
[TVZ25DN271KBS](#) [TVZ25D301KBS](#) [TVZ20EC911KBS](#) [TVZ20EBN911KBS](#) [TVZ18EC471KBS](#) [B72220S350K101](#) [B72540E300K62](#)
[TND10V-271KB00AAA0](#) [NTE1V030](#) [NTE1V275](#) [NTE2V015](#) [NTE2V035](#)