

## VDR-4032 SMD Disc Varistors

### FEATURES

- Improved component design in a compact case
- High surge current capability
- Superior performance at high temperature
- SMD mountable disk varistors, suitable for lead-free reflow / wave soldering

### APPLICATIONS

- Power supplies for telecommunication systems
- Protection for LED circuits
- Protection for consumer, industrial equipment
- Protection for automotive electronics

### APPLICABLE STANDARDS

- UL1449 TYPE5 E525940
- TUV B115439 002 IEC61051-1, -2, -2-2, IEC60950-1Annex Q IEC 62368-1:2018/G.8.1
- IEC61000-4-5
- GB/T10193-1997 GB/T10194-1997/GB8898 GB4943.1 CQCNO:22001333056

### TYPE CODE DESIGNATION

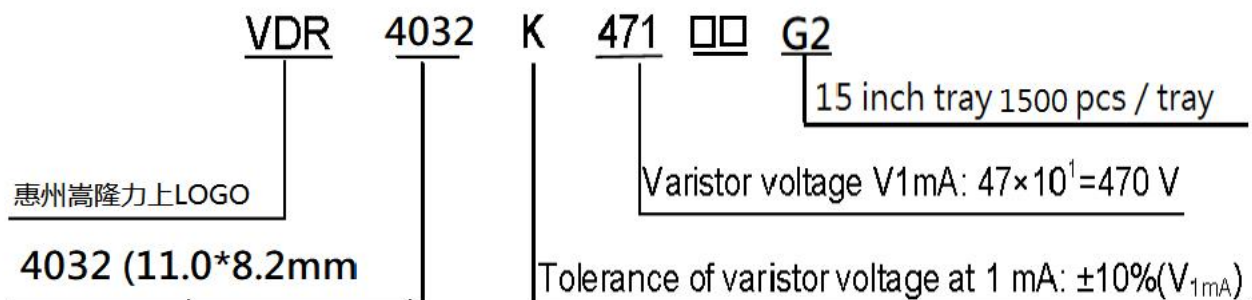

### General parameters

Parameter name	Parameter value	UNIT
working temperature	-55 — +125	°C
Storage temperature	-55 — +125	°C
Withstand voltage	≥2.5	KV <sub>RMS</sub>
Insulation resistance	≥100	MΩ

### Structure and size

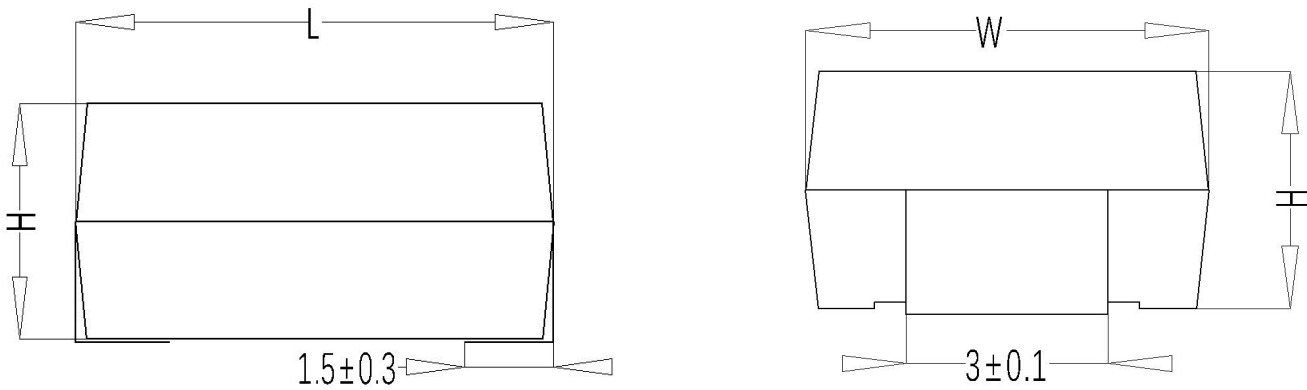

(UNIT:mm)

size	Varistor voltage range (V)	L	W	H
4032	V <sub>1ma</sub> =201—681	11.0±0.3	8.2±0.3	4.8±0.3
	V <sub>1ma</sub> =751—821			5.5±0.3

### Welding size

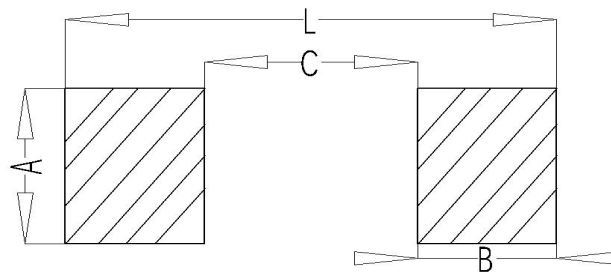

(UNIT:mm)

SIZE	A	B	C	L
4032	3.5	2.8	6.5	12.1

**Electrical characteristics (Standard)**

Model	Varistor voltage (@1mA DC)	Maximum Clamping Voltage		Maximum Allowable Voltage (8/20 $\mu$ s)		Max Surge 8/20 $\mu$ s	Energy (10/1000 $\mu$ s)	Rated Powe	Typical Capacitance (Reference) @1KHZ
	V <sub>1mA</sub> (V)	V <sub>AC</sub> (V)	V <sub>DC</sub> (V)	V <sub>p</sub> (V)	I <sub>p</sub> (A)	I max (A)	W max (J)	P (W)	C(pF)
4032K201	200(180-220)	130	170	340	25	2500	25.0	0.4	500
4032K221	220(198-242)	140	180	360	25	2500	27.0	0.4	450
4032K241	240(216-264)	150	200	395	25	2500	30.0	0.4	420
4032K271	270(243-297)	175	225	455	25	2500	35.0	0.4	370
4032K301	300(270-330)	195	250	500	25	2500	40.0	0.4	330
4032K331	330(297-363)	210	275	550	25	2500	42.0	0.4	300
4032K361	360(324-396)	230	300	595	25	2500	45.0	0.4	280
4032K391	390(351-429)	250	320	650	25	2500	50.0	0.4	260
4032K431	430(387-473)	275	350	710	25	2500	55.0	0.4	230
4032K471	470(423-517)	300	385	775	25	2500	60.0	0.4	210
4032K511	510(459-561)	320	410	845	25	2500	67.0	0.4	200
4032K561	560(504-616)	350	450	930	25	2500	69.0	0.4	180
4032K621	620(558-682)	395	510	1020	25	2500	70.0	0.4	160
4032K681	680(612-748)	420	560	1120	25	2500	72.0	0.4	150
4032K751	750(675-825)	460	615	1235	25	2500	75.0	0.4	130



### Electrical characteristics (High energy)

Model	Varistor voltage (@1mA DC)	Maximum Clamping Voltage		Maximum Allowable Voltage (8/20 $\mu$ s)		Max Surge 8/20 $\mu$ s	Energy (10/1000 $\mu$ s)	Rated Power	Typical Capacitance (Reference) @1KHZ
	V <sub>1mA</sub> (V)	V <sub>AC</sub> (V)	V <sub>DC</sub> (V)	V <sub>p</sub> (V)	I <sub>p</sub> (A)	I max (A)	W max (J)	P (W)	C(pF)
4032K201-H	200(180-220)	130	170	340	25	3500	35	0.4	500
4032K221-H	220(198-242)	140	180	360	25	3500	39	0.4	450
4032K241-H	240(216-264)	150	200	395	25	3500	42	0.4	420
4032K271-H	270(243-297)	175	225	455	25	3500	49	0.4	370
4032K301-H	300(270-330)	195	250	500	25	3500	54	0.4	330
4032K331-H	330(297-363)	210	275	550	25	3500	58	0.4	300
4032K361-H	360(324-396)	230	300	595	25	3500	65	0.4	280
4032K391-H	390(351-429)	250	320	650	25	3500	70	0.4	260
4032K431-H	430(387-473)	275	350	710	25	3500	80	0.4	230
4032K471-H	470(423-517)	300	385	775	25	3500	85	0.4	210
4032K511-H	510(459-561)	320	410	845	25	3500	90	0.4	200
4032K561-H	560(504-616)	350	450	930	25	3500	92	0.4	180
4032K621-H	620(558-682)	395	510	1020	25	3500	95	0.4	160
4032K681-H	680(612-748)	420	560	1120	25	3500	98	0.4	150
4032K751-H	750(675-825)	460	615	1235	25	3500	100	0.4	130

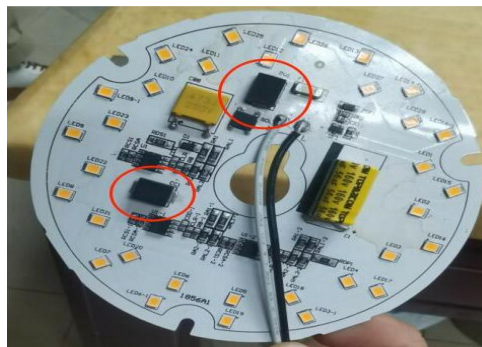

### Electrical characteristics (Combined wave)

Model	Varistor voltage (@1mA DC)	Maximum Clamping Voltage		Maximum Allowable Voltage (8/20 $\mu$ s)		Surge 4KV/2KA 1.2/50+8/20 $\mu$ s (times)	Energy (10/1000 $\mu$ s)	Rated Power	Typical Capacitance (Reference) @1KHZ
	V <sub>1mA</sub> (V)	V <sub>AC</sub> (V)	V <sub>DC</sub> (V)	V <sub>p</sub> (V)	I <sub>p</sub> (A)	I max 3500A 8/2 $\mu$ s(1time)	W max (J)	P (W)	C(pF)
4032K201-EC	200(180-220)	130	170	340	25	40	25.0	0.4	500
4032K221-EC	220(198-242)	140	180	360	25	40	27.0	0.4	450
4032K241-EC	240(216-264)	150	200	395	25	40	30.0	0.4	420
4032K271-EC	270(243-297)	175	225	455	25	40	35.0	0.4	370
4032K301-EC	300(270-330)	195	250	500	25	40	40.0	0.4	330
4032K331-EC	330(297-363)	210	275	550	25	40	42.0	0.4	300
4032K361-EC	360(324-396)	230	300	595	25	40	45.0	0.4	280
4032K391-EC	390(351-429)	250	320	650	25	40	50.0	0.4	260
4032K431-EC	430(387-473)	275	350	710	25	40	55.0	0.4	230
4032K471-EC	470(423-517)	300	385	775	25	40	60.0	0.4	210
4032K511-EC	510(459-561)	320	410	845	25	40	67.0	0.4	200
4032K561-EC	560(504-616)	350	450	930	25	40	69.0	0.4	180
4032K621-EC	620(558-682)	395	510	1020	25	40	70.0	0.4	160
4032K681-EC	680(612-748)	420	560	1120	25	40	72.0	0.4	150
4032K751-EC	750(675-825)	460	615	1235	25	40	75.0	0.4	130

### SOLDERING GUIDELINES

The usage of mild, non-activated fluxes for soldering is recommended, as well as proper cleaning of the PCB. The components are suitable for reflow soldering per JEDEC J-STD-020C.

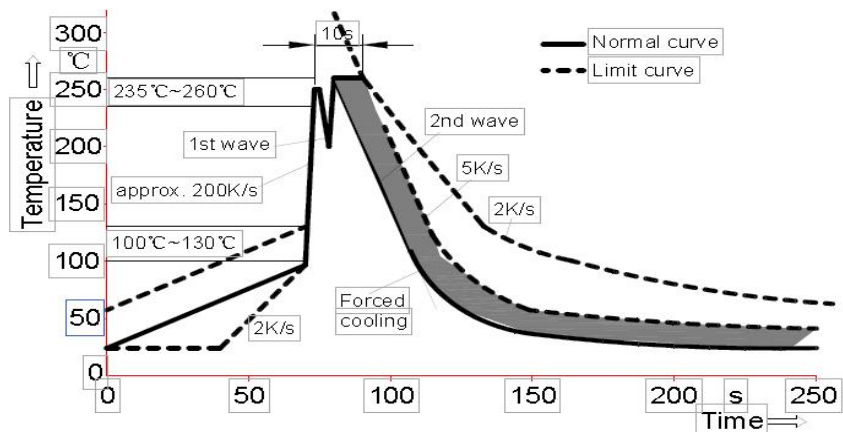

- Wave soldering Temperature characteristics at component terminal with dual-wave soldering

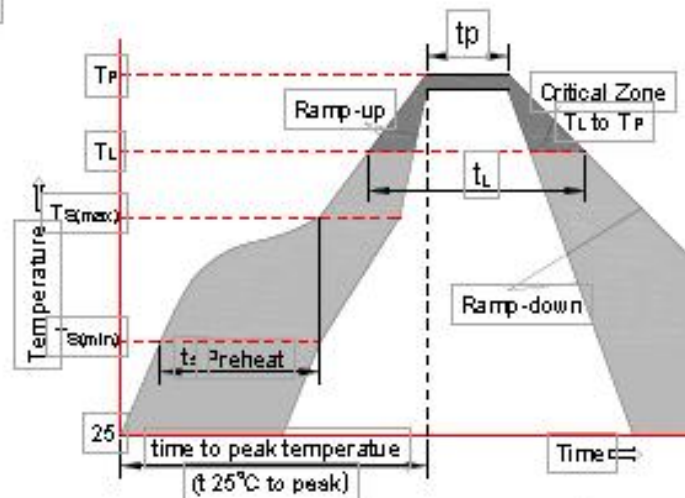
**- Reflow soldering**

Profile feature		Sn-Pb assembly	Pb-Free assembly
Average ramp-up rate ( $T_{s(max)}$ to $T_p$ )		3°C/sec. Max	3°C/sec. Max
Preheat	-Temperature min. ( $T_{s(min)}$ )	+100°C	+150°C
	-Temperature max. ( $T_{s(max)}$ )	+150°C	+200°C
	-Time ( $t_{s(min)}$ to $t_{s(max)}$ )	60-120 secs.	60-180 secs.
$T_{s(max)}$ to $T_L$ - Ramp-up Rate		3°C/sec. Max	3°C/sec. Max
Time maintained above	-Temperature min. ( $T_L$ )	+183°C	+217°C
	-Time ( $t_L$ )	60-150 secs.	60-150 secs.
Peak classification temperature ( $T_p$ )		+220°C to +240°C	+240°C to +260°C
Time within 5°C of actual peak temperature ( $t_p$ )		10 secs. to 30 secs.	20 secs. to 40 secs.
Ramp-down rate		6°C/sec. max.	6°C/sec. max.
Time 25°C to peak temperature		6 min. max.	8 min. max.

Notes: All temperature refer to topside of the package, measured on the package body surface

Maximum number of reflow cycles: 3

**STORAGE CONDITION**

- As far as possible, the components should be employed within 24 months after delivery from Kangtai Semiconductor.
- They should be left in their original packing to avoid soldering problems due to oxidized contacts.
- Storage temperature: - 25 up to + 45°C.
- Relative humidity: < 75 % annual average, < 95 % on max. 30 days in a year.





V/I CHARACTERISTICS V-I

VDR 4032K201 – 4032K471(H/EC)

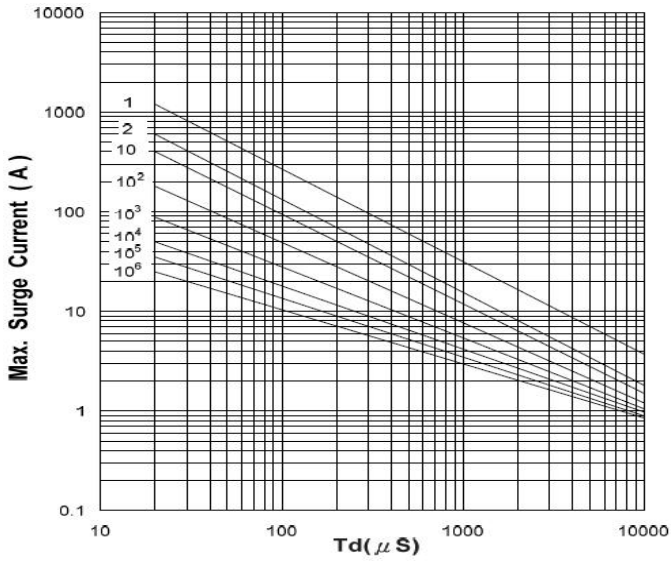

VDR 4032K511 – 4032K821(H/EC)

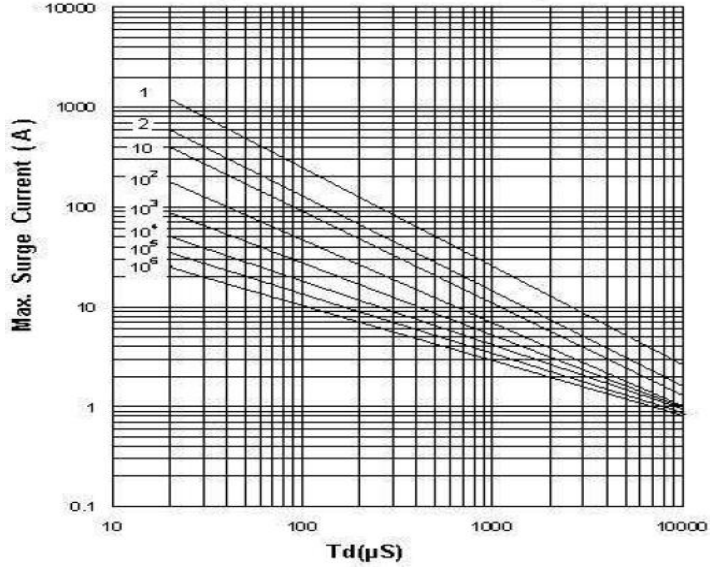

VDR 4032K201 – 4032K471(H/EC)

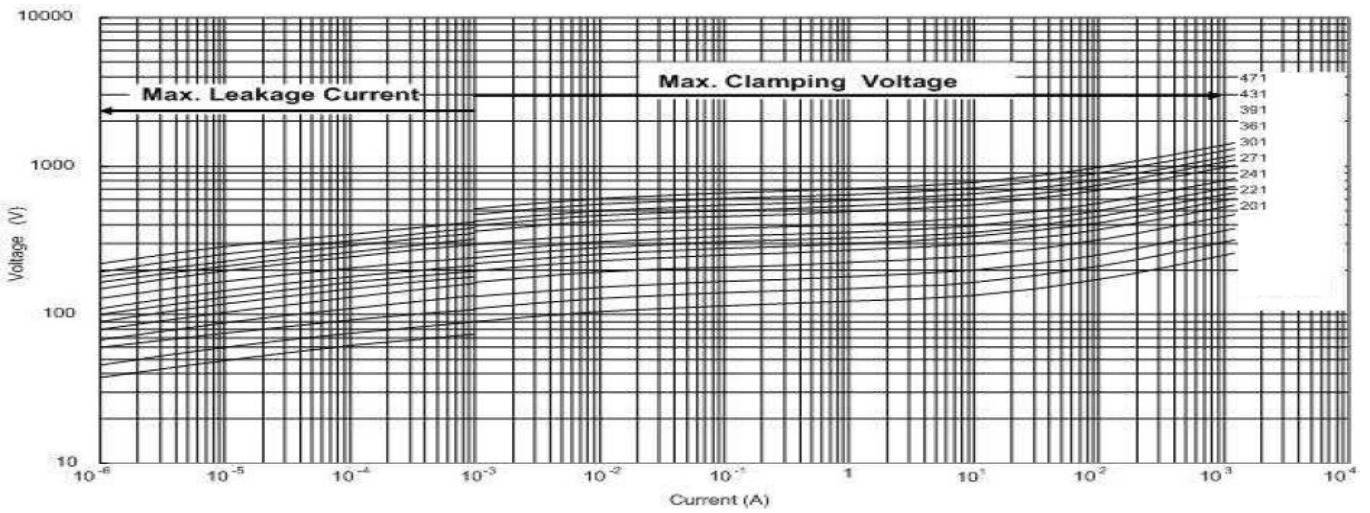

VDR 4032K511 – 4032K751(H/EC)

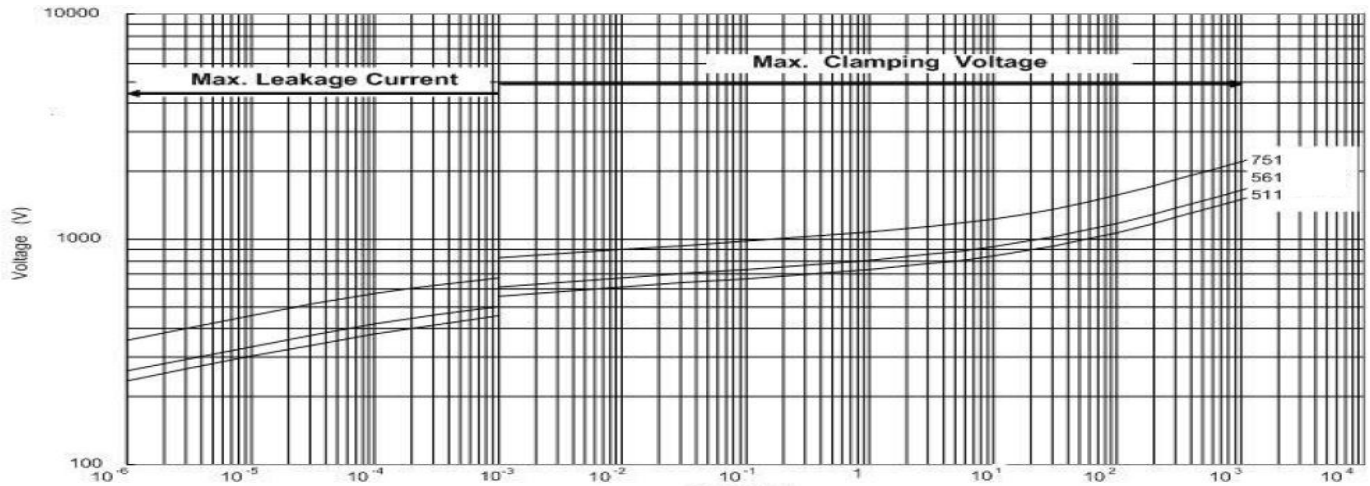

### Packing

Tape packing method description 24mm tape size

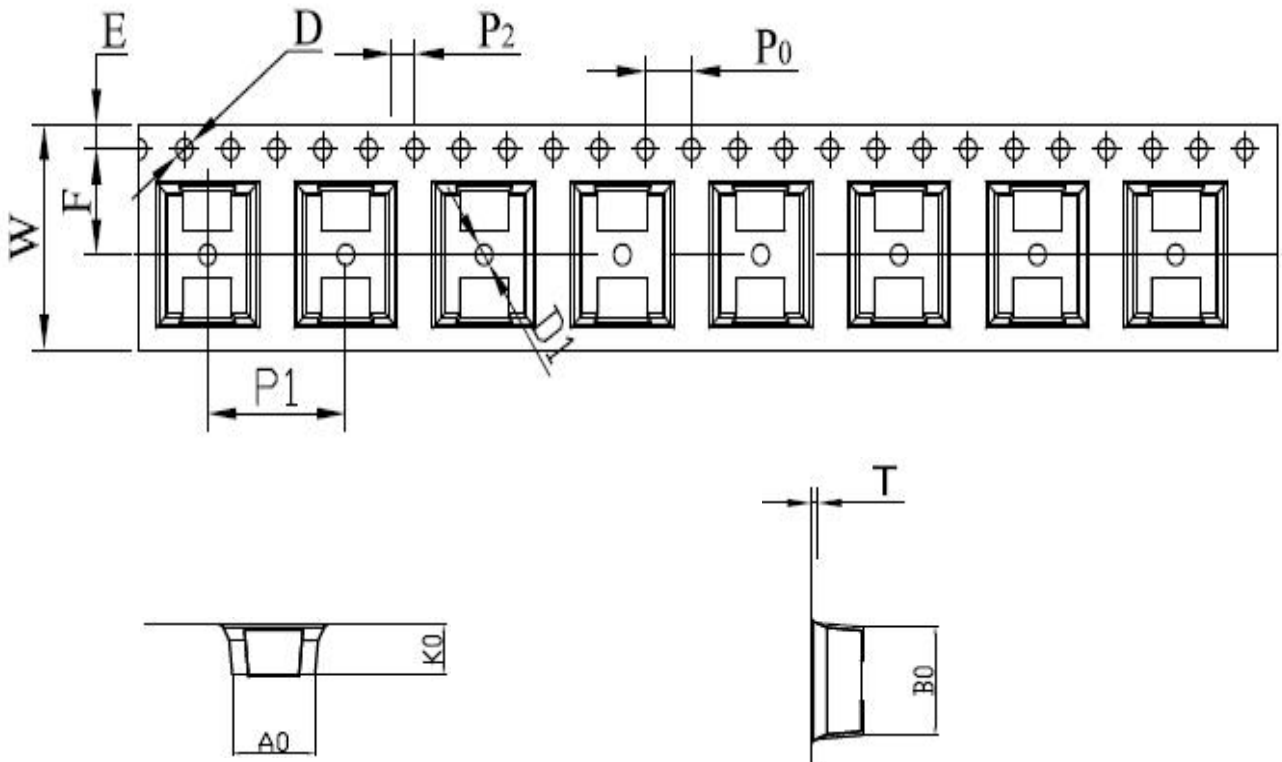

symbol	<b>AO</b>	<b>BO</b>	<b>KO</b>	<b>PO</b>	<b>P1</b>	<b>P2</b>	长度/盘
Spec	8.50±0.1	11.50±0.1	5.30±0.1	4.00±0.10	12.0±0.10	2.00±0.10	18300mm
symbol	<b>W</b>	<b>T</b>	<b>E</b>	<b>F</b>	<b>DO</b>	<b>D1</b>	元件/盘
Spec	24.0±0.3	0.40±0.05	1.75±0.10	11.50±0.1	1.50 <sup>+0.1</sup> <sub>-0</sub>	1.50±0.10	1500 pcs





### 15 inch rubber disc size

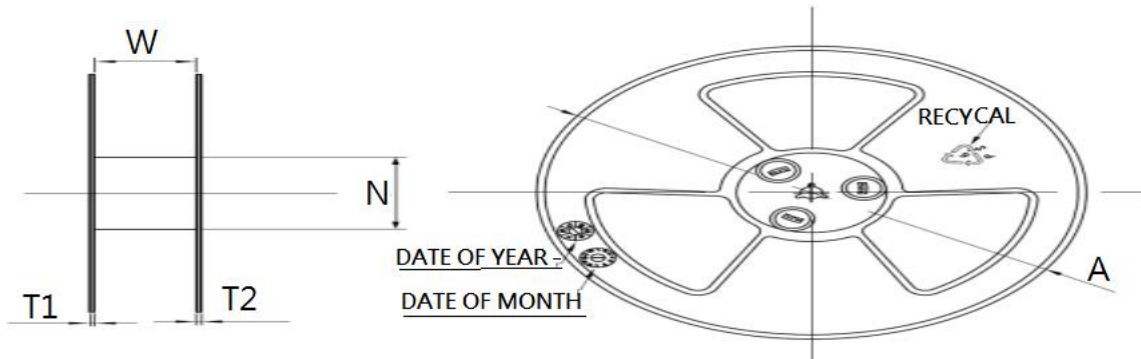

SPEC	24.0
$E \pm 0.5$	2.3
$F \pm 0.5$	10.75
$W \pm 0.5$	24.4
$T1 \pm 0.3$	2.2
$T2 \pm 0.3$	2.2
$A +0-2$	$\varnothing 380$
$N \pm 3.0$	$\varnothing 100$
$D \pm 0.3$	13.3

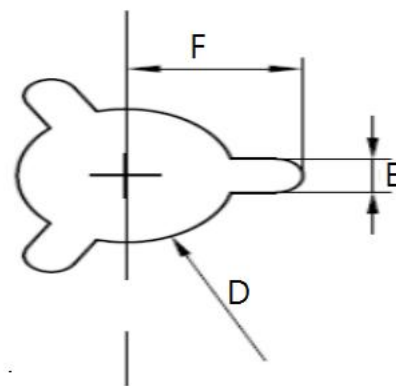

### Packing carton

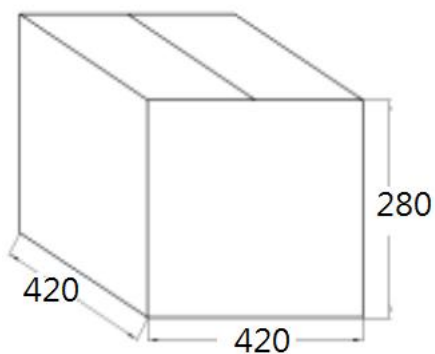

1500pcs\*10  
 15000pcs



## X-ON Electronics

Largest Supplier of Electrical and Electronic Components

*Click to view similar products for [Varistors](#) category:*

*Click to view products by [VDR](#) manufacturer:*

Other Similar products are found below :

[R71ZOV151HC](#) [B72205S271K111](#) [B72214S110K151](#) [B72214S251K151](#) [B72540E250K62](#) [NTE1V020](#) [NTE1V130](#) [25FN511K](#)  
[S10K11G5S5](#) [ERZ-C14DK361U](#) [ERZ-C20DK221U](#) [ERZ-C32CK201B](#) [207869-1](#) [AS-13](#) [B72214S200K551](#) [B72280B112K1](#) [B72540E](#)  
[350K 62](#) [B72590D360A60](#) [B72650M301K93](#) [B72670M1140K72](#) [TVZ18EC271KBS](#) [TVZ20EB911KBS](#) [TVZ25D201KBS](#) [TVZ25D241KBS](#)  
[VDRH20X230BSE](#) [VZ07D220KBS](#) [VZ40D241KQ-N](#) [VZ40D241K](#) [VZ25D511KBS-N](#) [VZ20E511KBSX](#) [VZ20E221KBSX](#)  
[VZ10D471KBS-N](#) [ERZ-V20R221](#) [20A9FN241K](#) [B72205S350K211](#) [B72214S110K551](#) [B72510E140K62](#) [B72650M350K72](#)  
[TVZ25DN271KBS](#) [TVZ25D301KBS](#) [TVZ20EC911KBS](#) [TVZ20EBN911KBS](#) [TVZ18EC471KBS](#) [B72220S350K101](#) [B72540E300K62](#)  
[TND10V-271KB00AAA0](#) [NTE1V030](#) [NTE1V275](#) [NTE2V015](#) [NTE2V035](#)