

VI TELEFILTER**Filter specification****TFS 800****1/5****Measurement condition**

| | | |
|------------------------|----|-----|
| Ambient temperature: | 23 | °C |
| Input power level: | 0 | dBm |
| Terminating impedance: | | |
| Input: | 50 | Ω |
| Output: | 50 | Ω |

Characteristics**Remark:**

The maximum attenuation in the pass band is defined as the insertion loss a_e . The nominal frequency f_N is fixed at 800 MHz without any tolerance or limit. The values of absolute attenuation a_{abs} are guaranteed for the whole operating temperature range. The frequency shift of the filter in the operating temperature range is included in the production tolerance scheme.

| D a t a | | typ. value | tolerance / limit |
|---|-----------|-------------------|--------------------------|
| Insertion loss | a_e | 1,7 dB | max. 3,0 dB |
| Nominal frequency | f_N | - | 800,0 MHz |
| Passband | PB | - | $f_N \pm 6,0$ MHz |
| Pass band ripple | | 0,5 dB | max. 1,0 dB |
| Absolute attenuation | a_{abs} | | |
| 0,3 MHz ... 770 MHz | | 43 dB | min. 40 dB |
| 820 MHz ... 836 MHz | | 44 dB | min. 10 dB |
| 881 MHz ... 1200 MHz | | 48 dB | min. 40 dB |
| 1200 MHz ... 2000 MHz | | 33 dB | min. 20 dB |
| VSWR within PB | | 1,8 : 1 | max. 2,2 : 1 |
| Input power level | | - | max. 10 dBm |
| Operating temperature range | OTR | - | - 40 °C ... + 80 °C |
| Storage temperature range | | - | - 40 °C ... + 85 °C |
| Temperature coefficient of frequency | TC_f^* | - 42 ppm / K | - |

$^*) \Delta f(\text{Hz}) = TC_f(\text{ppm/K}) \times (T - T_0) \times f_{T_0}(\text{MHz})$

Generated:**Checked / Approved:**

Tele Filter GmbH
Potsdamer Straße 18
D 14 513 TELTOW / Germany
Tel: (+49) 3328 4784-0 / Fax: (+49) 3328 4784-30
E-Mail: tft@vectron.com

VI TELEFILTER reserves the right to make changes to the product(s) and/or information contained herein without notice. No liability is assumed as a result of their use or application. No rights under any patent accompany the sale of any such product(s) or information.

Filter characteristic

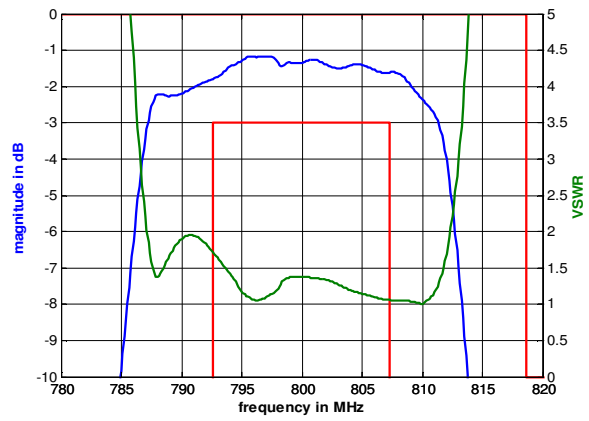
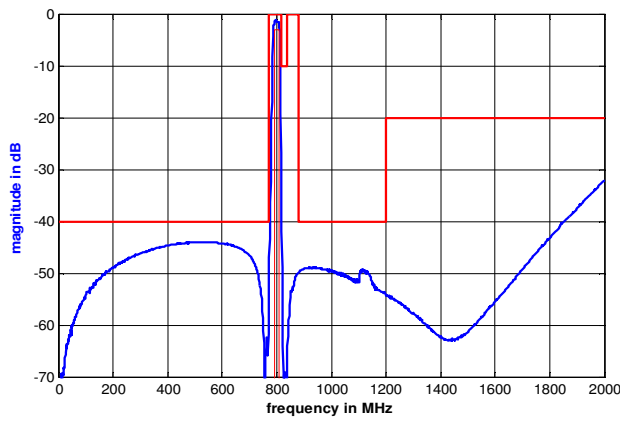

Construction and pin connection

(All dimensions in mm)

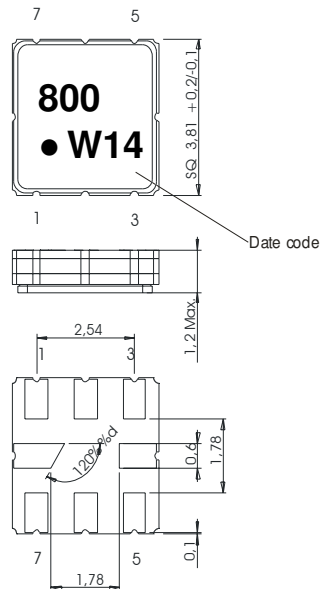

- 1 Ground
- 2 Input
- 3 Ground
- 4 Ground
- 5 Ground
- 6 Output
- 7 Ground
- 8 Ground

Date code: Year + week
 W 2008
 X 2009
 A 2010
 ...

50 Ω Test circuit

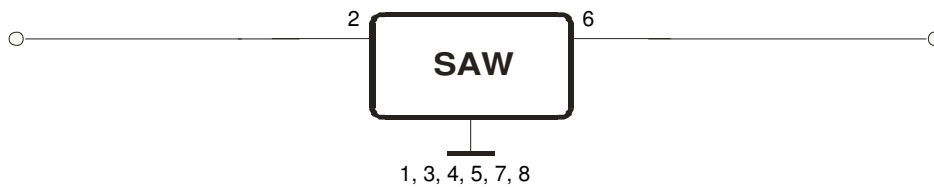

Tele Filter GmbH
 Potsdamer Straße 18
 D 14 513 TELTOW / Germany
 Tel: (+49) 3328 4784-0 / Fax: (+49) 3328 4784-30
 E-Mail: tft@vectron.com

VI TELEFILTER reserves the right to make changes to the product(s) and/or information contained herein without notice. No liability is assumed as a result of their use or application. No rights under any patent accompany the sale of any such product(s) or information.

Stability characteristics, reliability

After the following tests the filter shall meet the whole specification:

1. Shock: 500g, 1 ms, half sine wave, 3 shocks each plane;
DIN IEC 68 T2 - 27
2. Vibration: 10 Hz to 500 Hz, 0,35 mm or 5 g respectively, 1 octave per min, 10 cycles per plan, 3 plans;
DIN IEC 68 T2 - 6
3. Change of temperature: -55 °C to 125°C / 30 min. each / 10 cycles
DIN IEC 68 part 2 – 14 Test N
4. Resistance to solder heat (reflow): reflow possible: three times max.;
for temperature conditions refer to the attached "Air reflow temperature conditions" on page 4;

This filter is RoHS compliant (2002/95/EG, 2005/618/EG)

Packing

Tape & Reel: IEC 286 – 3, with exception of value for N and minimum bending radius;
tape type II, embossed carrier tape with top cover tape on the upper side;

max. pieces of filters per reel: 3000
 reel of empty components at start: min. 300 mm
 reel of empty components at start including leader: min. 500 mm
 trailer: min. 300 mm

Tape (all dimensions in mm)

- W : 12,00 ± 0,3
- Po : 4,00 ± 0,1
- Do : 1,50 +0,1/-0
- E : 1,75 ± 0,1
- F : 5,50 ± 0,05
- G(min) : 0,75
- P2 : 2,00 ± 0,05
- P1 : 8,00 ± 0,1
- D1(min) : 1,50
- Ao : 4,30 ± 0,1
- Bo : 4,30 ± 0,1
- Ct : 9,5 ± 0,1

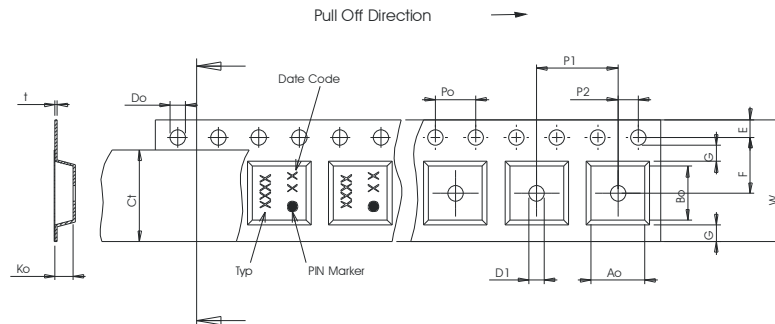

Reel (all dimensions in mm)

- A : 330
- W1 : 12,4 +2/-0
- W2(max) : 13,4
- N(min) : 50
- C : 13,0 +0,5/-0,2

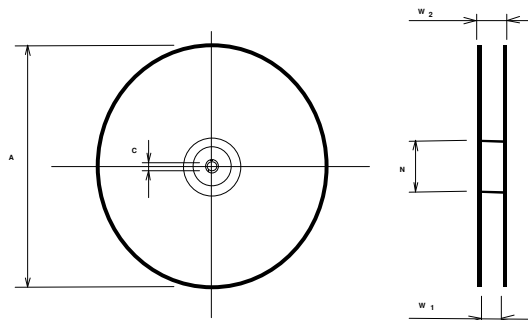

The minimum bending radius is 45 mm.

Tele Filter GmbH
Potsdamer Straße 18
D 14 513 TELTOW / Germany
Tel: (+49) 3328 4784-0 / Fax: (+49) 3328 4784-30
E-Mail: tft@vectron.com

VI TELEFILTER reserves the right to make changes to the product(s) and/or information contained herein without notice. No liability is assumed as a result of their use or application. No rights under any patent accompany the sale of any such product(s) or information.

Air reflow temperature conditions

| Conditions | Exposure |
|--|-----------------------------|
| Average ramp-up rate (30°C to 217°C) | less than 3°C/second |
| > 100°C | between 300 and 600 seconds |
| > 150°C | between 240 and 500 seconds |
| > 217°C | between 30 and 150 seconds |
| Peak temperature | max. 260°C |
| Time within 5°C of actual peak temperature | between 10 and 30 seconds |
| Cool-down rate (Peak to 50°C) | less than 6°C/second |
| Time from 30°C to Peak temperature | no greater than 300 seconds |

Chip-mount air reflow profile

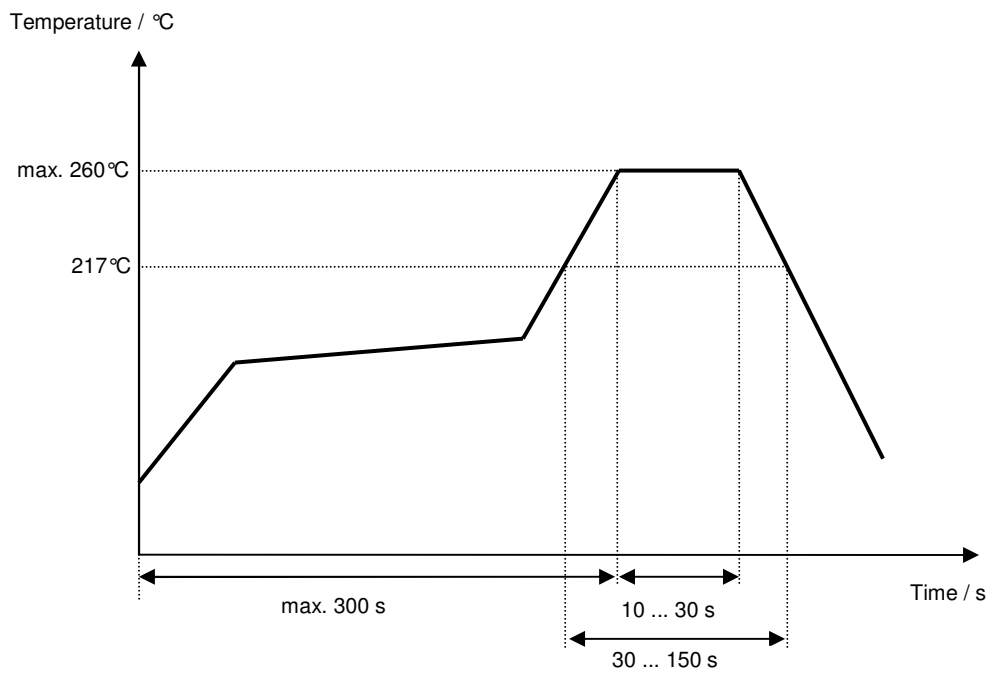

Tele Filter GmbH
Potsdamer Straße 18
D 14 513 TELTOW / Germany
Tel: (+49) 3328 4784-0 / Fax: (+49) 3328 4784-30
E-Mail: tft@vectron.com

VI TELEFILTER reserves the right to make changes to the product(s) and/or information contained herein without notice. No liability is assumed as a result of their use or application. No rights under any patent accompany the sale of any such product(s) or information.

VI TELEFILTER**Filter specification****TFS 800****5/5****History**

| Version | Reason of Changes | Name | Date |
|----------------|--|-------------|-------------|
| 1.0 | - Generation of development specification | Springfeldt | 15.04.2004 |
| 1.1 | - Generation of filter specification - Add typical value - Add filter characteristic | Noack | 13.10.2004 |
| 1.2 | - Change operating temperature range and stability characteristics | Strehl | 15.05.2006 |
| 1.3 | - Change operating temperature range | Strehl | 03.04.2008 |

X-ON Electronics

Largest Supplier of Electrical and Electronic Components

Click to view similar products for [Signal Conditioning](#) category:

Click to view products by [Vectron](#) manufacturer:

Other Similar products are found below :

[MAPDCC0001](#) [MAPDCC0004](#) [PD0409J5050S2HF](#) [880157](#) [HHS-109-PIN](#) [DC1417J5005AHF](#) [AFS14A30-2185.00-T3](#) [AFS14A35-1591.50-T3](#) [DS-323-PIN](#) [B39321R801H210](#) [1A0220-3](#) [JP510S](#) [LFB212G45SG8C341](#) [LFB322G45SN1A504](#) [LFL182G45TC3B746](#) [SF2159E](#) [30057](#)
[FM-104-PIN](#) [CER0813B](#) [MAPDCC0005](#) [3A325](#) [40287](#) [41180](#) [ATB3225-75032NCT](#) [BD0810N50100AHF](#) [BD2425J50200AHF](#)
[C5060J5003AHF](#) [JHS-115-PIN](#) [JP503AS](#) [DC0710J5005AHF](#) [DC2327J5005AHF](#) [DC3338J5005AHF](#) [43020](#) [LFB2H2G60BB1C106](#)
[LFL15869MTC1B787](#) [X3C19F1-20S](#) [XC3500P-20S](#) [10013-20](#) [SF2194E](#) [CDBLB455KCAX39-B0](#) [TGL2208-SM, EVAL](#) [RF1353C](#)
[PD0922J5050D2HF](#) [1E1305-3](#) [1F1304-3S](#) [1G1304-30](#) [B0922J7575AHF](#) [2020-6622-20](#) [TP-102-PIN](#) [TP-103-PIN](#)