

Measurement condition

Ambient temperature T_A :	23	°C
Input power level:	0	dBm
Terminating impedance: *		
Input:	120 Ω	-2.4 pF
Output:	140 Ω	-2.4 pF

Characteristics

Remark:

Reference level for the relative attenuation a_{rel} of the TFS868T is the minimum of the pass band attenuation a_{min} . The minimum of the pass band attenuation a_{min} is defined as the insertion loss a_e . The centre frequency f_c is the arithmetic mean value of the upper and lower frequencies at the 3 dB filter attenuation level relative to the insertion loss a_e . The nominal frequency f_N is fixed at 868.80 MHz without tolerance. The given values for the relative attenuation a_{rel} have to be reached at the frequencies given below even if the centre frequency f_c is shifted due to the temperature coefficient of frequency TC_f in the operating temperature range and due to a production tolerance for the centre frequency f_c .

D a t a		typ. value	tolerance / limit
Insertion loss	a_e	2.85 dB	max. 3.6 dB
(reference level)			
Nominal frequency	f_N	-	868.80 MHz
Centre frequency	f_c	868.80 MHz	-
Passband	PB	1.30 MHz	min. \pm 300 kHz
Passband ripple	p-p	0.6 dB	max. 3 dB
Amplitude ripple $f_N \pm 200$kHz	p-p	0.45 dB	max. 2 dB
Relative attenuation	a_{rel}		
f_N	$f_N \pm 200.0$ kHz	0.45 dB	max. 2 dB
$f_N \pm 200.0$ kHz	$f_N \pm 300.0$ kHz	0.52 dB	max. 3 dB
$f_N - 858.3$ MHz	$f_N - 12.3$ MHz	56 dB	min. 50 dB
$f_N - 12.3$ MHz	$f_N - 2.8$ MHz	36 dB	min. 30 dB
$f_N + 2.7$ MHz	$f_N + 11.7$ MHz	41 dB	min. 30 dB
$f_N + 11.7$ MHz	$f_N + 21.7$ MHz	43 dB	min. 40 dB
$f_N + 21.7$ MHz	$f_N + 27.7$ MHz	51 dB	min. 45 dB
$f_N + 27.7$ MHz	$f_N + 131.7$ MHz	57 dB	min. 50 dB
Input power level		-	max. 12 dBm
Operating temperature range	OTR	-	- 20 °C ... + 70 °C
Storage temperature range		-	- 55 °C ... + 125 °C
Frequency inversion temperature		10 °C	-
Temperature coefficient of frequency	TC_f **	-0.033 ppm/K ²	-

*) The terminating impedances depend on parasitics and q-values of matching elements and the board used and are to be understood as reference values only. Should there be additional questions do not hesitate to ask for an application note or contact our design team.

**) $\Delta f = TC_f(T - T_0)^2 f_N$

Generated:

Checked / Approved:

Vectron International GmbH
Potsdamer Straße 18
D 14 513 TELTOW / Germany
Tel: (+49) 3328 4784-0 / Fax: (+49) 3328 4784-30
E-Mail: tft@vectron.com

Vectron International GmbH reserves the right to make changes to the product(s) and/or information contained herein without notice. No liability is assumed as a result of their use or application. No rights under any patent accompany the sale of any such product(s) or information.

Filter characteristic

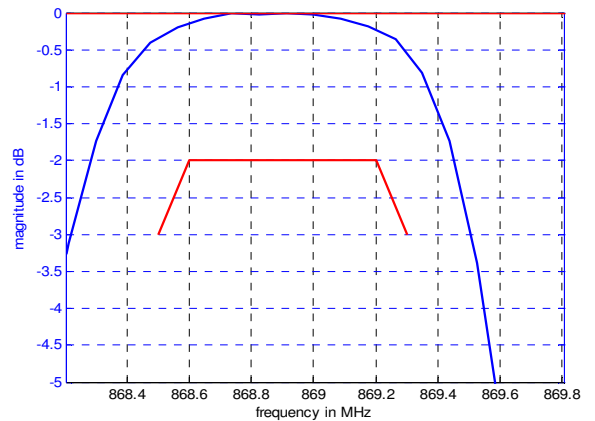
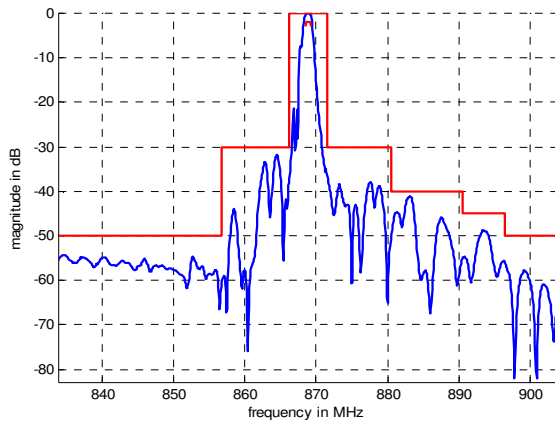

Construction and pin connection

(All dimensions in mm)

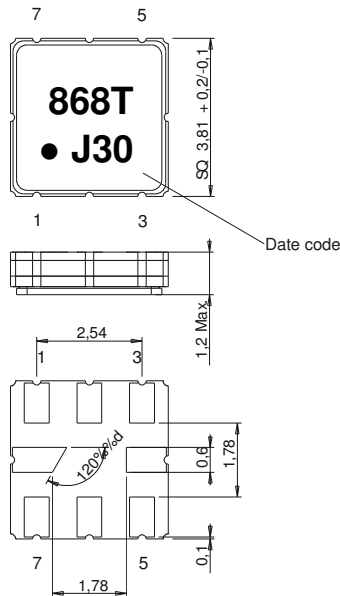

- 1 Input
- 2 Ground
- 3 Ground
- 4 Ground
- 5 Output
- 6 Ground
- 7 Ground
- 8 Ground

Date code: Year + week
 J 2017
 K 2018
 L 2019
 ..

50 Ω Test circuit

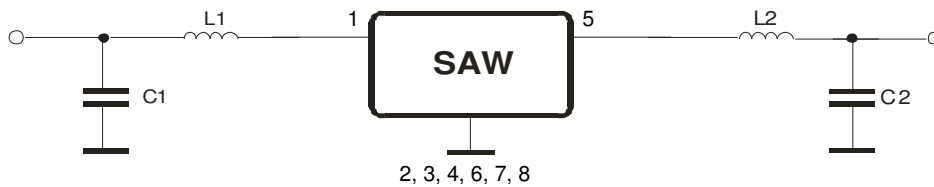

Vectron International GmbH
 Potsdamer Straße 18
 D 14 513 TELTOW / Germany
 Tel: (+49) 3328 4784-0 / Fax: (+49) 3328 4784-30
 E-Mail: tft@vectron.com

Vectron International GmbH reserves the right to make changes to the product(s) and/or information contained herein without notice. No liability is assumed as a result of their use or application. No rights under any patent accompany the sale of any such product(s) or information.

Stability characteristics, reliability

After the following tests the filter shall meet the whole specification:

1. Shock: 500 g, 1 ms, half sine wave, 3 shocks each plane;
DIN IEC 60068 T2 - 27
2. Vibration: 10 Hz to 2000 Hz, 0.35 mm or 5 g respectively, 1 octave per min, 10 cycles per plane, 3 planes; DIN IEC 60068 T2 - 6
3. Change of temperature: -55 °C to 125 °C / 15 min. each / 100 cycles
DIN IEC 60068 part 2 – 14 Test N
4. Resistance to solder heat (reflow): reflow possible: three times max.;
for temperature conditions refer to the attached "Air reflow temperature conditions" on page 4;
5. SAW devices are Electrostatic Discharge (ESD) sensitive devices.

This filter is RoHS compliant (2011/65/EU)

Packing

Tape & Reel: IEC 286 – 3, with exception of value for N and minimum bending radius;
tape type II, embossed carrier tape with top cover tape on the upper side;

reel of empty components at start:	min. 300 mm
reel of empty components at start including leader:	min. 500 mm
trailer:	min. 300 mm

Tape (all dimensions in mm)

- W : 12.00 ±0.3
- Po : 4.00 ±0.1
- Do : 1.50 +0.1/-0
- E : 1.75 ±0.1
- F : 5.50 ±0.05
- G(min) : 0.75
- P2 : 2.00 ±0.05
- P1 : 8.00 ±0.1
- D1(min) : 1.50
- Ao : 4.30 ±0.1
- Bo : 4.30 ±0.1
- Ct : 9.2 ±0.1
- Ko : 1.80 ±0.1
- t : 0.30 ±0.05

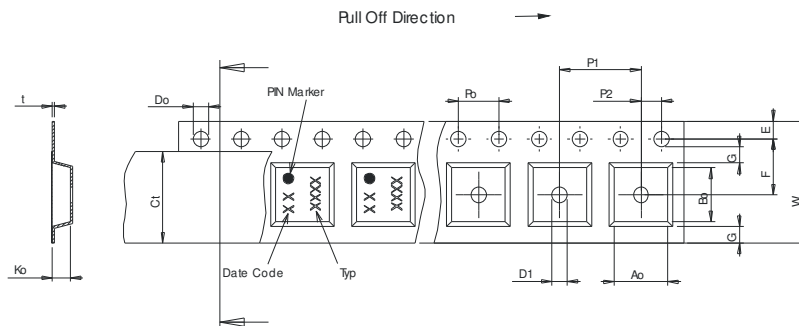

Reel (all dimensions in mm)

- A : 330 or 180
- W1 : 12.4 +2/-0
- W2(max) : 18.40
- N(min) : 50.00
- C : 13.0 +0.5/-0.2

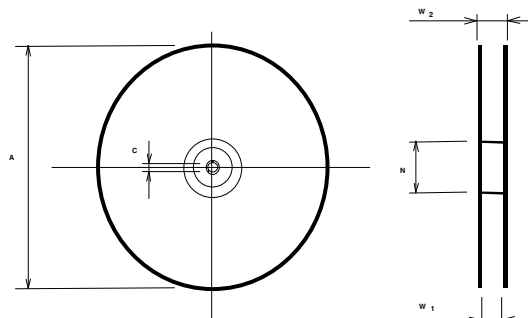

The minimum bending radius is 45 mm.

Vectron International GmbH
Potsdamer Straße 18
D 14 513 TELTOW / Germany
Tel: (+49) 3328 4784-0 / Fax: (+49) 3328 4784-30
E-Mail: tft@vectron.com

Vectron International GmbH reserves the right to make changes to the product(s) and/or information contained herein without notice. No liability is assumed as a result of their use or application. No rights under any patent accompany the sale of any such product(s) or information.

Air reflow temperature conditions

Conditions	Exposure
Average ramp-up rate (30 °C to 217 °C)	less than 3 °C / second
> 100 °C	between 300 and 600 seconds
> 150 °C	between 240 and 500 seconds
> 217 °C	between 30 and 150 seconds
Peak temperature	max. 260 °C
Time within 5 °C of actual peak temperature	between 10 and 30 seconds
Cool-down rate (Peak to 50 °C)	less than 6 °C / second
Time from 30 °C to Peak temperature	no greater than 300 seconds

Chip-mount air reflow profile

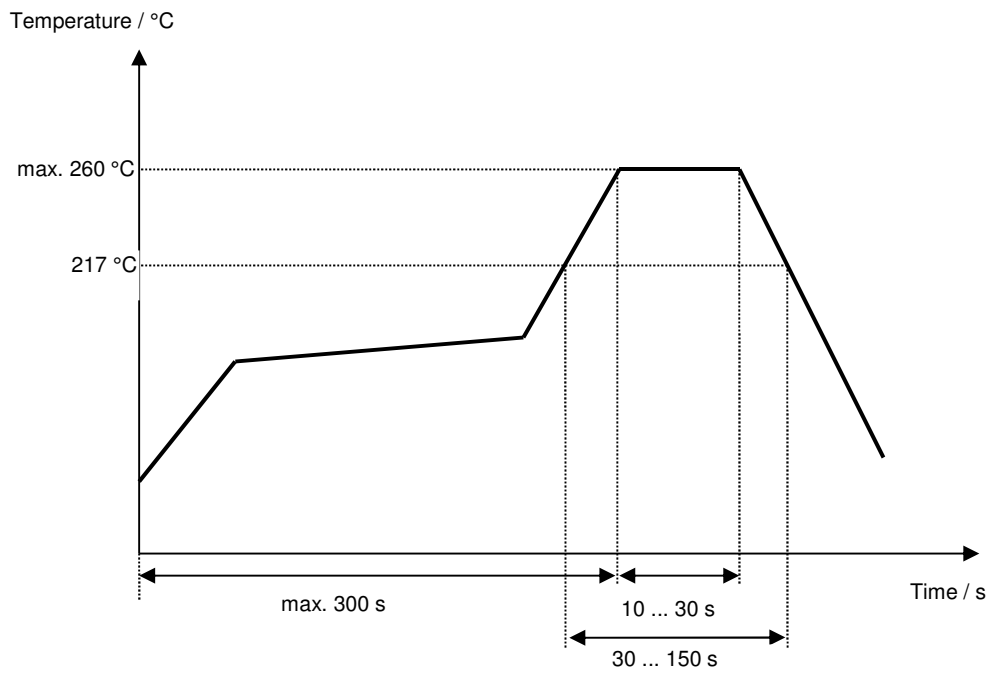

Vectron International GmbH
 Potsdamer Straße 18
 D 14 513 TELTOW / Germany
 Tel: (+49) 3328 4784-0 / Fax: (+49) 3328 4784-30
 E-Mail: tft@vectron.com

Vectron International GmbH reserves the right to make changes to the product(s) and/or information contained herein without notice. No liability is assumed as a result of their use or application. No rights under any patent accompany the sale of any such product(s) or information.

History

Version	Reason of Changes	Name	Date
1.0	- generation of filter specification	Abutaimah	09.03.2017
2.0	- correct passband ripple conditions - update storage temperature range - update tape & reel dimensions - update tape & reel pull off direction - correct typo in remark section	Bonnen	25.07.2017

X-ON Electronics

Largest Supplier of Electrical and Electronic Components

Click to view similar products for [Signal Conditioning](#) category:

Click to view products by [Vectron](#) manufacturer:

Other Similar products are found below :

[MAPDCC0001](#) [MAPDCC0004](#) [PD0409J5050S2HF](#) [880157](#) [HHS-109-PIN](#) [DC1417J5005AHF](#) [AFS14A30-2185.00-T3](#) [AFS14A35-1591.50-T3](#) [DS-323-PIN](#) [B39321R801H210](#) [1A0220-3](#) [JP510S](#) [LFB212G45SG8C341](#) [LFB322G45SN1A504](#) [LFL182G45TC3B746](#) [SF2159E](#) [30057](#)
[FM-104-PIN](#) [CER0813B](#) [MAPDCC0005](#) [3A325](#) [40287](#) [41180](#) [ATB3225-75032NCT](#) [BD0810N50100AHF](#) [BD2425J50200AHF](#)
[C5060J5003AHF](#) [JHS-115-PIN](#) [JP503AS](#) [DC0710J5005AHF](#) [DC2327J5005AHF](#) [DC3338J5005AHF](#) [43020](#) [LFB2H2G60BB1C106](#)
[LFL15869MTC1B787](#) [X3C19F1-20S](#) [XC3500P-20S](#) [10013-20](#) [SF2194E](#) [CDBLB455KCAX39-B0](#) [TGL2208-SM, EVAL](#) [RF1353C](#)
[PD0922J5050D2HF](#) [1E1305-3](#) [1G1304-30](#) [B0922J7575AHF](#) [2020-6622-20](#) [TP-102-PIN](#) [TP-103-PIN](#) [BD1222J50200AHF](#)