

Total solder points: 108
Difficulty level: beginner 1 2 3 4 5 advanced

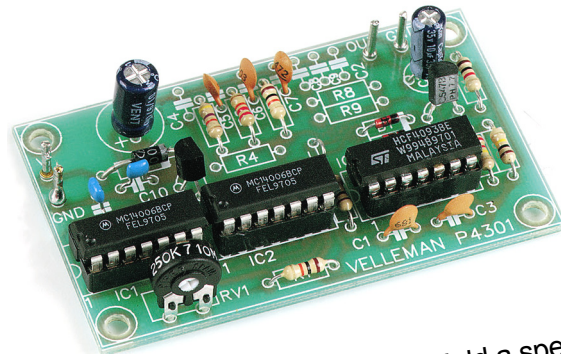

PINK NOISE GENERATOR



K4301

Add a spectrum analyser with a microphone
and check your audio system performance.

ILLUSTRATED ASSEMBLY MANUAL

H4301IP-1



To analyse the acoustic properties of a room (usually a living- room), a good pink noise generator together with a spectrum analyser is indispensable. Moreover you need a microphone with as linear a frequency characteristic as possible (from 20 to 20000Hz.). If, in addition, you dispose of an equaliser, then you can not only check but also correct reproduction.

Features:

- Random digital noise.
- 33 bit shift register.
- Clock frequency adjustable between 30KHz and 100KHz.
- Pink noise filter: -3 dB per octave (20 .. 20000Hz.).
- Easily adaptable to produce "white noise".

Specifications:

- Output voltage: 150mV RMS./ clock frequency 40KHz.
- Output impedance: 1K ohm.
- Power supply: 9 to 12VAC, or 12 to 15VDC / 5mA.

Assembly hints

velleman®

1. Assembly (Skipping this can lead to troubles !)

Ok, so we have your attention. These hints will help you to make this project successful. Read them carefully.

1.1 Make sure you have the right tools:

- A good quality soldering iron (25-40W) with a small tip.
- Wipe it often on a wet sponge or cloth, to keep it clean; then apply solder to the tip, to give it a wet look. This is called 'tinning' and will protect the tip, and enables you to make good connections. When solder rolls off the tip, it needs cleaning.
- Thin raisin-core solder. Do not use any flux or grease.
- A diagonal cutter to trim excess wires. To avoid injury when cutting excess leads, hold the lead so they cannot fly towards the eyes.
- Needle nose pliers, for bending leads, or to hold components in place.
- Small blade and Phillips screwdrivers. A basic range is fine.

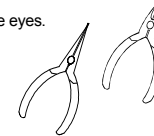
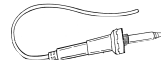

For some projects, a basic multi-meter is required, or might be handy

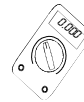

1.2 Assembly Hints :

- ⇒ Make sure the skill level matches your experience, to avoid disappointments.
- ⇒ Follow the instructions carefully. Read and understand the entire step before you perform each operation.
- ⇒ Perform the assembly in the correct order as stated in this manual
- ⇒ Position all parts on the PCB (Printed Circuit Board) as shown on the drawings.
- ⇒ Values on the circuit diagram are subject to changes, the values in this assembly guide are correct*
- ⇒ Use the check-boxes to mark your progress.
- ⇒ Please read the included information on safety and customer service

* Typographical inaccuracies excluded. Always look for possible last minute manual updates, indicated as 'NOTE' on a separate leaflet.

1.3 Soldering Hints :

1- Mount the component against the PCB surface and carefully solder the leads

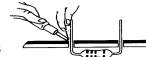

2- Make sure the solder joints are cone-shaped and shiny



3- Trim excess leads as close as possible to the solder joint



4

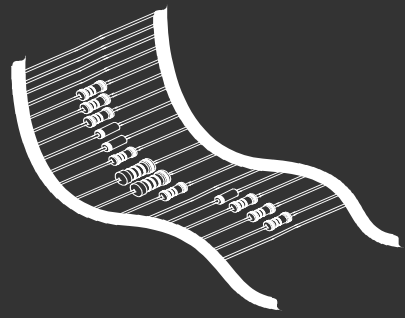

REMOVE THEM FROM THE TAPE ONE AT A TIME !

Included in this kit

2. RESISTOR

R1: 120 (1 - 2 - 1 - B)

COLOUR	COLOUR NAME	1ST DIGIT/ STRIPE	2ND DIGIT/ STRIPE	3RD DIGIT/ STRIPE	MULTIPLIER STRIPE	TOLERANCE
Black	BLACK	0	0	0	x1	1%
Brown	BROWN	1	1	1	x10	
Red	RED	2	2	2	x100	
Orange	ORANGE	3	3	3	x1.000	
Yellow	YELLOW	4	4	4	x10.000	
Green	GREEN	5	5	5	x100.000	
Blue	BLUE	6	6	6	x1.000.000	

**DO NOT BLINDLY FOLLOW THE ORDER OF THE COMPONENTS ONTO THE TAPE.
ALWAYS CHECK THEIR VALUE ON THE PARTS LIST!**

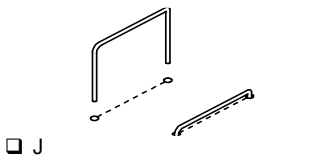
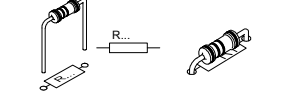
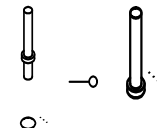
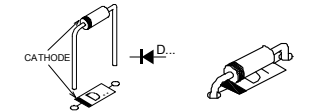
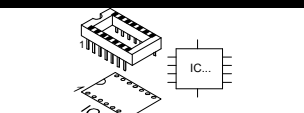
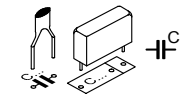
<p>1. Jumper wire</p>  <p><input type="checkbox"/> J</p>	<p>3. Resistors</p>  <p><input type="checkbox"/> R1 : 10K (1-0-3-B) <input type="checkbox"/> R2 : 100K (1-0-4-B) <input type="checkbox"/> R3 : 100K (1-0-4-B) <input type="checkbox"/> R5 : 47K (4-7-3-B) <input type="checkbox"/> R6 : 22K (2-2-3-B) <input type="checkbox"/> R7 : 10K (1-0-3-B) <input type="checkbox"/> R10 : 220K (2-2-4-B) <input type="checkbox"/> R11 : 1K (1-0-2-B)</p>	<p>5. PCB tabs</p>  <p><input type="checkbox"/> V : 1X <input type="checkbox"/> GND : 2X <input type="checkbox"/> OUT : 1X</p>
<p>2. Diodes. Watch the polarity !</p>  <p><input type="checkbox"/> D1 : 1N4148 <input type="checkbox"/> D2 : 1N4148 <input type="checkbox"/> D3 : 1N4007</p>	<p>4. IC sockets. (check the position of</p>  <p><input type="checkbox"/> IC1 : 14p <input type="checkbox"/> IC2 : 14p <input type="checkbox"/> IC3 : 14p</p>	<p>6. Capacitors</p>  <p><input type="checkbox"/> C1 : 680pF (681) <input type="checkbox"/> C3 : 10nF (103) <input type="checkbox"/> C5 : 22nF (223) <input type="checkbox"/> C6 : 10nF (103) <input type="checkbox"/> C7 : 4n7 (472) <input type="checkbox"/> C10 : 100n (104) <input type="checkbox"/> C11 : 100n (104)</p>

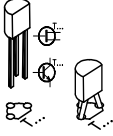
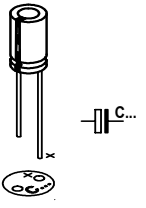
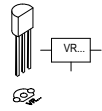
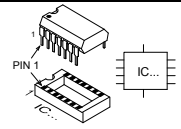
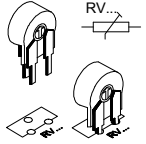
<p>7. Transistor</p> <p>☐ T1 : BC547B</p> 	<p>10. Capacitors. Watch the polarity !</p> <p>☐ C12 : 10µF ☐ C13 : 100µF</p> 
<p>8. Voltage regulator</p> <p>Mind the orientation !</p> <p>☐ VR1 : UA78L08</p> 	<p>11. ICs. (check the position of the notch)</p>  <p>☐ IC1 : CD4006 ☐ IC2 : CD4006 ☐ IC3 : CD4093</p>
<p>9. Trimmer</p> <p>☐ RV1 : 220K</p> 	

12. TEST & ADJUSTMENT

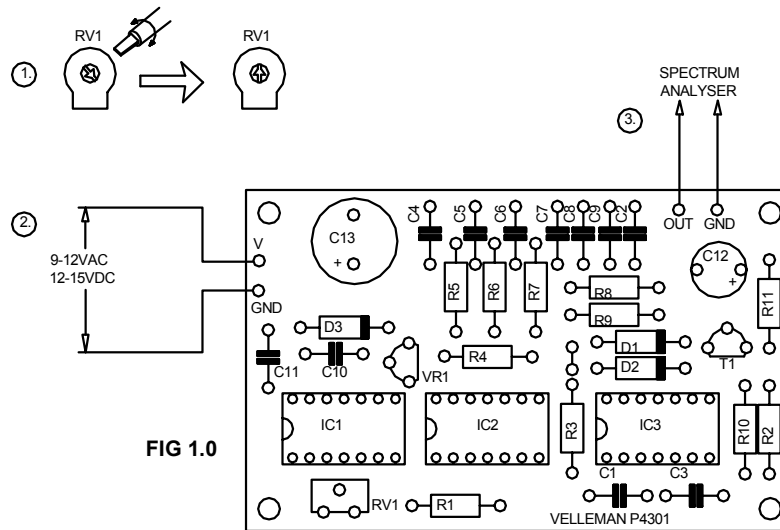

1. Turn trimmer RV1 to its centre position.
 2. Connect a power supply :
 - AC, 9 to 12 V then between points GND and V.
 - DC, 12 to 15 V (battery or power supply) then - to GND and + to V.
 3. Connect the output (OUT, GND) to the input of a spectrum analyser, using a screened flex (screen to GND).
- Now adjust the noise signal using trimmer RV1 so as to obtain as flat a reproduction characteristic as possible. Especially pay attention to the higher frequencies (adjust spectrum analyser sensitivity if necessary).

 **Remark:** *the nature of the lower frequencies (32 and 64Hz) makes their read-out unstable.*

FOR THOSE WHO LIKE TO EXPERIMENT : By adapting C1 you can also modify the clock frequency (pin 3 of IC2) of the shift register (e.g. C1=18pF for a clock frequency up to and beyond 500KHz), so as to obtain a "white noise" at 500KHz and to adapt the filter (C2=100pF, do not fit C4 through C9). Output voltage will drop down to +/- 100mV RMS.

13. Schematic diagram.

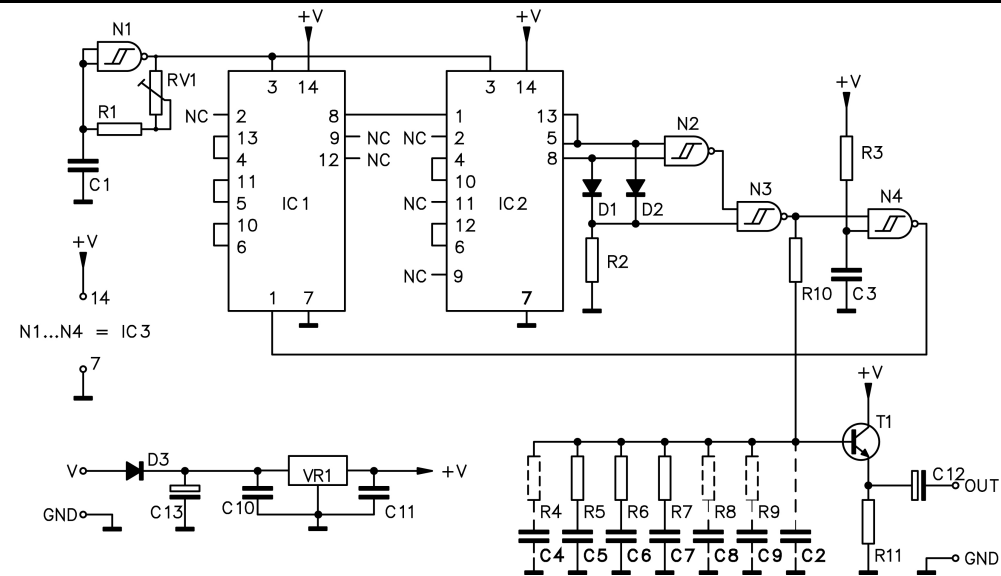

14. PCB

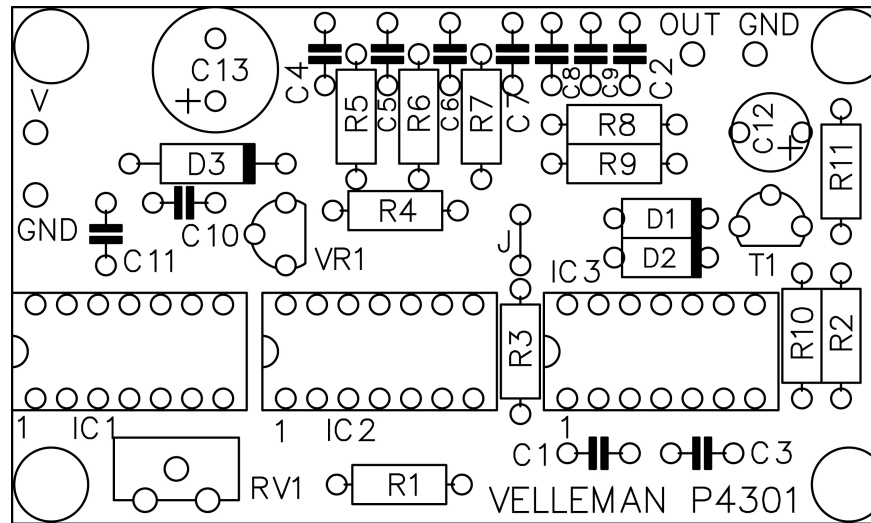

EDU 01 SOLDERLESS EDUCATIVE STARTERBOX



The EDU01 basic experiment kit is the first step into the world of modern electronics. Build your own circuits in a fun, safe and educative way.



EDU 05 USB TUTOR BOARD



Learn how to connect your computer with the outside world, master the USB communication with tutorial examples. Play with LED indicators and learn how to drive LCD displays.



EDU 02 SOLAR ENERGY EXPERIMENT KIT



Fun solar powered projects. Learn all about solar energy.

EDU 06 SCOPE EDUKIT



This board with different signals will teach you how to use an oscilloscope. Optimized instructions for use of our HPS140 oscilloscope. YouTube demo movies.

EDU 03 SOLDER EDUCATIVE STARTER BOX

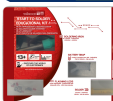

Learn how to solder, build different exciting projects. Includes spare components and demo boards.



EDU 10 PIC™ TUTOR KIT



Enter the world of microcontroller programming, easy step by step instructions. Includes programmer and test board.

COMING SOON

Modifications and typographical errors reserved - © Velleman nv. H4301IP - 2012 - ED1 (rev2)



X-ON Electronics

Largest Supplier of Electrical and Electronic Components

Click to view similar products for [Velleman](#) manufacturer:

Other Similar products are found below :

[MK137](#) [MK106](#) [K/TRANS1](#) [K/RES-E3](#) [K/TF300](#) [MK108](#) [K2634](#) [MK152](#) [MK123](#) [K8086](#) [MK149](#) [VM100](#) [MK144](#) [MK190](#) [K1803](#)
[MK134](#) [K/CAP1](#) [MK111](#) [OMSB36](#) [MK103](#) [K/DIODE1](#) [MK109](#) [MK135](#) [MK150](#) [MK112](#) [MK120](#) [K/RES-E12](#) [VTHH6](#)