

DCM™ DC-DC Converter

DCM3623xA5N53B4y7z



Isolated, Regulated DC Converter

Features & Benefits

- Isolated, regulated DC-DC converter
- Up to 240 W, 5.00 A continuous
- 90.7% peak efficiency
- 653 W/in³ Power density
- Wide input range 43 – 154 Vdc
- Safety Extra Low Voltage (SELV) 48.0 V Nominal Output
- 3000 Vdc isolation
- ZVS high frequency switching
 - Enables low-profile, high-density filtering
- Fully operational current limit
- OV, OC, UV, short circuit and thermal protection
- 3623 through-hole ChiP package
 - 1.524" x 0.898" x 0.284"
(38.72 mm x 22.8 mm x 7.21 mm)

Typical Applications

- Industrial
- Process Control
- Transportation / Heavy Equipment
- Defense / Aerospace

Product Ratings	
$V_{IN} = 43 \text{ V to } 154 \text{ V}$	$P_{OUT} = 240 \text{ W}$
$V_{OUT} = 48.0 \text{ V}$ (28.8 V to 52.8 V Trim)	$I_{OUT} = 5.00 \text{ A}$

Product Description

The DCM Isolated, Regulated DC Converter is a DC-DC converter, operating from an unregulated, wide range input to generate an isolated 48.0 Vdc output. With its high frequency zero voltage switching (ZVS) topology, the DCM converter consistently delivers high efficiency across the input line range. Modular DCM converters and downstream DC-DC products support efficient power distribution, providing superior power system performance and connectivity from a variety of unregulated power sources to the point-of-load.

Leveraging the thermal and density benefits of Vicor's ChiP packaging technology, the DCM module offers flexible thermal management options with very low top and bottom side thermal impedances. Thermally-adept ChiP based power components enable customers to achieve cost effective power system solutions with previously unattainable system size, weight and efficiency attributes, quickly and predictably.

Part Ordering Information

Product Function	Package Size		Package Type	Max Input Voltage	Range Ratio	Max Output Voltage	Max Output Power	Temperature Grade	Option
DCM	36	23	x	A5	N	53	B4	y	7z
DCM = DC-DC Converter	Length in mm x 10	Width in mm x 10	T = Through hole ChiPs	Internal Reference				T = -40°C – 125°C M = -55°C – 125°C	70 = Enhanced V _{OUT} Regulation / Analog Control Interface Version

Typical Application

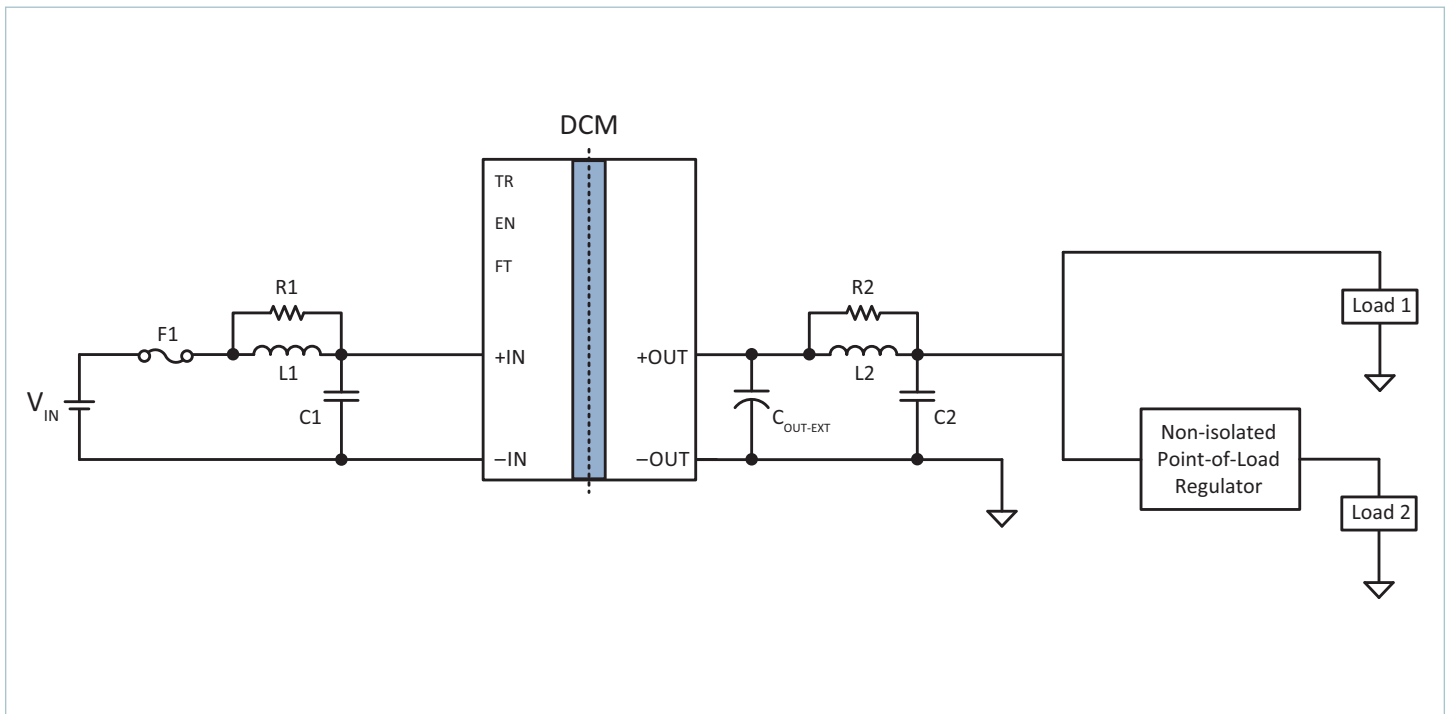

Typical Application 1: Single DCM3623xA5N53B4y7z, to a non-isolated regulator, and direct to load

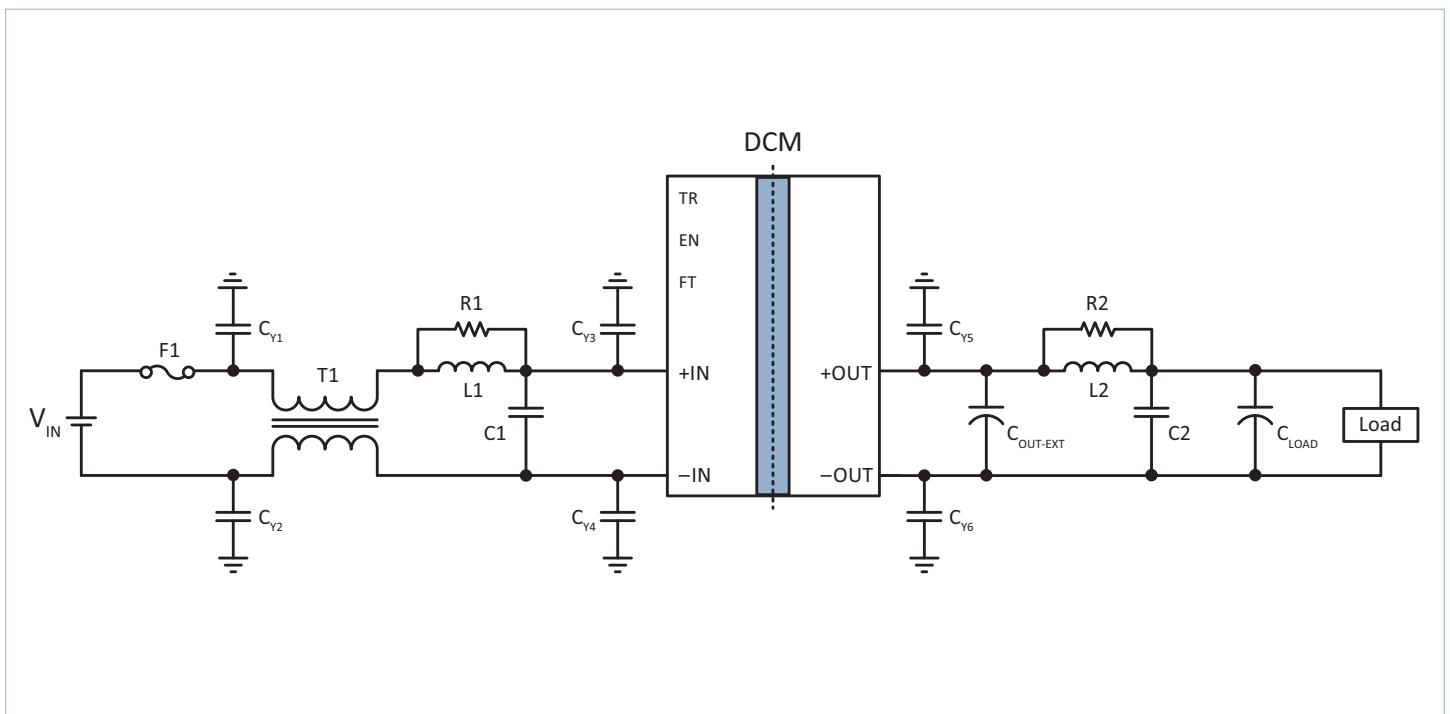

Typical Application 2: Single DCM3623xA5N53B4y7z with common- and differential-mode input filters

Pin Configuration

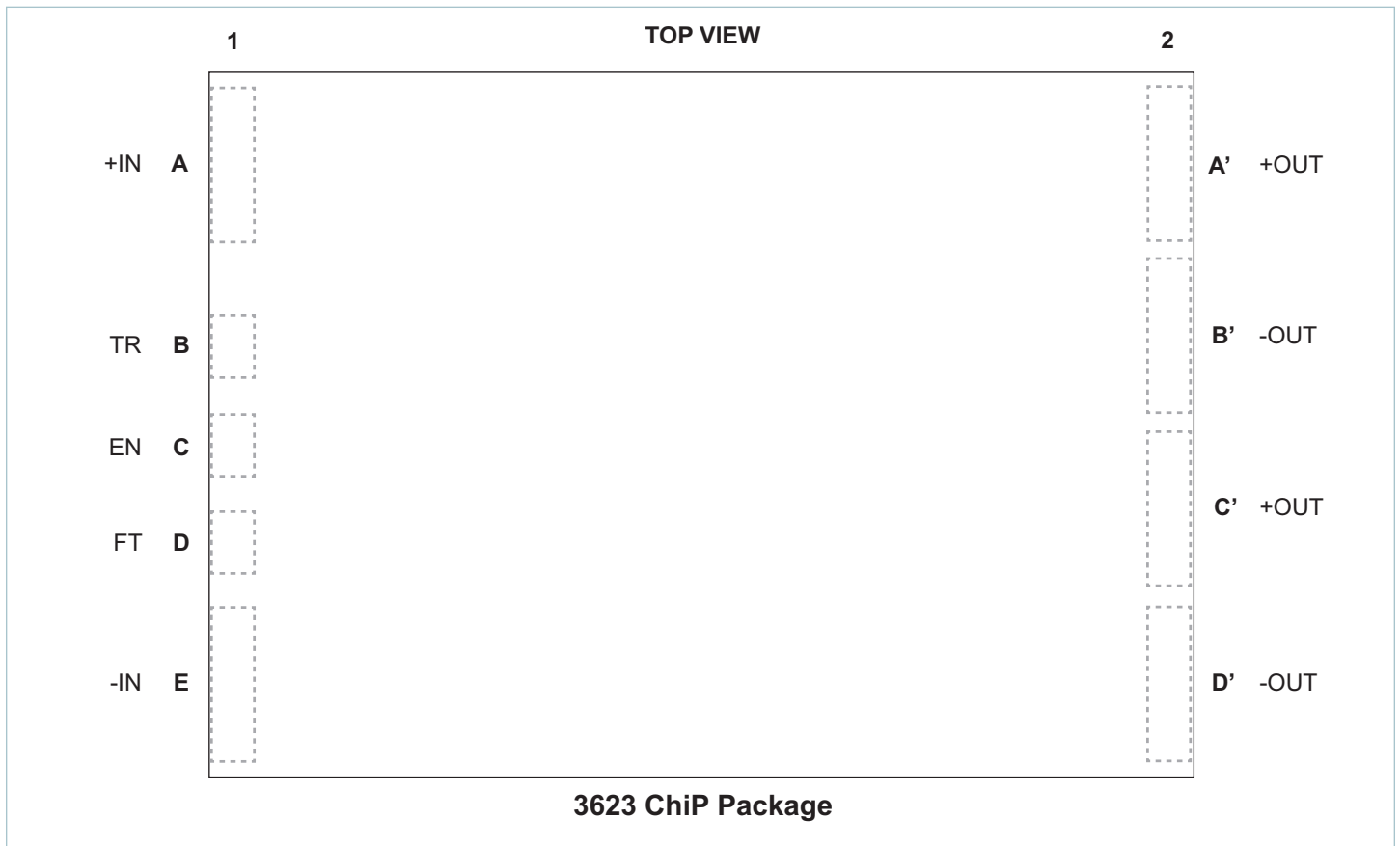

Pin Descriptions

Pin Number	Signal Name	Type	Function
A1	+IN	INPUT POWER	Positive input power terminal
B1	TR	INPUT	Enables and disables trim functionality. Adjusts output voltage when trim active.
C1	EN	INPUT	Enables and disables power supply
D1	FT	OUTPUT	Fault monitoring
E1	-IN	INPUT POWER RETURN	Negative input power terminal
A'2, C'2	+OUT	OUTPUT POWER	Positive output power terminal
B'2, D'2	-OUT	OUTPUT POWER RETURN	Negative output power terminal

Absolute Maximum Ratings

The absolute maximum ratings below are stress ratings only. Operation at or beyond these maximum ratings can cause permanent damage to the device. Electrical specifications do not apply when operating beyond rated operating conditions.

Parameter	Comments	Min	Max	Unit
Input Voltage (+IN to -IN)		-0.5	175.0	V
Input Voltage Slew Rate		-1	1	V/ μ s
TR to -IN		-0.3	3.5	V
EN to -IN		-0.3	3.5	V
FT to -IN		-0.3	3.5	V
			5	mA
Output Voltage (+Out to -Out)		-0.5	63.4	V
Dielectric withstand (input to output)	Supplementary insulation	3000		Vdc
Internal Operating Temperature	T Grade	-40	125	$^{\circ}$ C
	M Grade	-55	125	$^{\circ}$ C
Storage Temperature	T Grade	-40	125	$^{\circ}$ C
	M Grade	-65	125	$^{\circ}$ C
Average Output Current			8.5	A

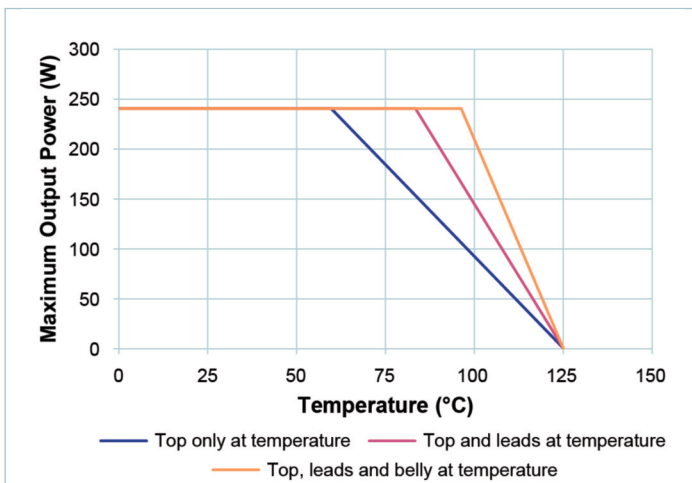

Figure 1 — Thermal Specified Operating Area: Max Output Power vs. Case Temp, module at minimum full load efficiency

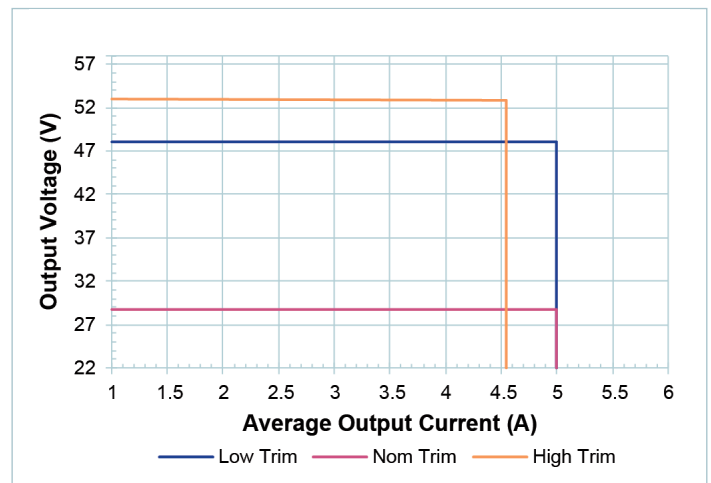

Figure 2 — Electrical Specified Operating Area

Electrical Specifications

Specifications apply over all line, trim and load conditions, internal temperature $T_{INT} = 25^{\circ}\text{C}$, unless otherwise noted. **Boldface** specifications apply over the temperature range of $-40^{\circ}\text{C} < T_{INT} < 125^{\circ}\text{C}$ for T grade and $-55^{\circ}\text{C} < T_{INT} < 125^{\circ}\text{C}$ for M grade.

Attribute	Symbol	Conditions / Notes	Min	Typ	Max	Unit
Power Input Specifications						
Input voltage range	V_{IN}	Continuous operation	43	100	154	V
Inrush current (peak)	I_{INRP}	With maximum C_{OUTEXT} , full resistive load			9.0	A
Input capacitance (internal)	C_{IN-INT}	Effective value at nominal input voltage		2.8		μF
Input capacitance (internal) ESR	$R_{CIN-INT}$	At 1 MHz		0.93		$\text{m}\Omega$
Input inductance (external)	L_{IN}	Differential mode, with no further line bypassing			1	μH
No Load Specifications						
Input power – disabled	P_Q	Nominal line, see Fig. 3		0.5	0.7	W
		Worst case line, see Fig. 3			0.8	W
Input power – enabled with no load	P_{NL}	Nominal line, see Fig. 4		2.5	7.1	W
		Worst case line, see Fig. 4			8.0	W
Power Output Specifications						
Output voltage set point	V_{OUTNOM}	At $V_{IN} = 100\text{V}$, nominal trim at 100% load, $T_{INT} = 25^{\circ}\text{C}$	47.76	48.0	48.24	V
Rated output voltage trim range	$V_{OUTTRIMMING}$	Trim range over temp, with > 10% rated load. Specifies the Low, Nominal and High Trim conditions.	28.8	48.0	52.8	V
Output voltage regulation	% V_{OUT} REGULATION	At nominal line, nominal trim, full load and ambient temperature	-0.5		0.5	%
		At nominal line, nominal trim and: • Load >20% of full load and ambient temperature • Full load and over temperature	-1.0		1.0	
		All other conditions (does not include light load regulation)	-1.5		2.5	
Output voltage accuracy	% $V_{OUTACCURACY}$	The total output voltage set-point accuracy from the calculated V_{OUT} based on load, temp and trim. Excludes: • ΔV_{OUTLL} • % $V_{OUTREGULATION}$	-2.0		3.0	%
Output voltage light load regulation	ΔV_{OUTLL}	0% to 10% load, additional V_{OUT} relative to V_{OUT} accuracy; see Design Guidelines section	-0.00		2.31	V
Rated output power	P_{OUT}	Continuous, $V_{OUT} \geq 48.0\text{V}$	240			W
Rated output current	I_{OUT}	Continuous, $V_{OUT} \leq 48.0\text{V}$	5.00			A
Output current limit	I_{OUTLM}	Of rated I_{OUT} max. Fully operational current limit, for nominal trim and below	100	120	135	%
Current limit delay	t_{OUTLIM}	The module will power limit in a fast transient event		1		ms
Efficiency	η	Full load, nominal line, nominal trim	88.6	90.7		%
		Full load, over line and temperature, nominal trim	86.4			%
		50% load, over rated line, temperature and trim	82.1			%
Output voltage ripple	V_{OUTPP}	20 MHz bandwidth. At nominal trim, minimum C_{OUTEXT} and at least 10 % rated load		944		mV
Output capacitance (internal)	C_{OUTINT}	Effective value at nominal output voltage		10		μF
Output capacitance (internal) ESR	$R_{COUTINT}$	At 1 MHz		8.000		$\text{m}\Omega$
Output capacitance (external)	C_{OUTEXT}	Excludes component temperature coefficient For load transients that remain > 10% rated load	200		4000	μF
Output capacitance (external)	$C_{OUTEXT-TRANS}$	Excludes component temperature coefficient For load transients down to 0% rated load, with static trim	220		4000	μF
Output capacitance (external)	$C_{OUTEXT-TRANS-TRIM}$	Excludes component temperature coefficient For load transients down to 0% rated load, with dynamic trimming	1500		4000	μF
Output capacitance, ESR (ext.)	$R_{COUTEXT}$	At 10 kHz, excludes component tolerances	10			$\text{m}\Omega$

Electrical Specifications (cont.)

Specifications apply over all line, trim and load conditions, internal temperature $T_{INT} = 25^{\circ}\text{C}$, unless otherwise noted. **Boldface** specifications apply over the temperature range of $-40^{\circ}\text{C} < T_{INT} < 125^{\circ}\text{C}$ for T grade and $-55^{\circ}\text{C} < T_{INT} < 125^{\circ}\text{C}$ for M grade.

Attribute	Symbol	Conditions / Notes	Min	Typ	Max	Unit
Power Output Specifications (Cont.)						
Initialization delay	t_{INIT}	See state diagram		25	40	ms
Output turn-on delay	t_{ON}	From rising edge EN, with V_{IN} pre-applied. See timing diagram		200		μs
Output turn-off delay	t_{OFF}	From falling edge EN. See timing diagram			600	μs
Soft start ramp time	t_{SS}	At full rated resistive load, with min C_{OUT_EXT}		262		ms
Output voltage threshold for max rated load current	$V_{OUT_FL_THRESH}$	During startup, V_{OUT} must achieve this threshold before output can support full rated current			24.0	V
Output current at startup	I_{OUT_START}	Max load current at startup while V_{OUT} is below $V_{OUT_FL_THRESH}$	0.50			A
Monotonic soft-start threshold voltage	$V_{OUT_MONOTONIC}$	Output voltage rise becomes monotonic with 10% of preload once it crosses $V_{OUT_MONOTONIC}$			24.0	V
Minimum required disabled duration	t_{OFF_MIN}	This refers to the minimum time a module needs to be in the disabled state before it will attempt to start via EN			2	ms
Minimum required disabled duration for predictable restart	$t_{OFF_MONOTONIC}$	This refers to the minimum time a module needs to be in the disabled state before it is guaranteed to exhibit monotonic soft-start and have predictable startup timing			100	ms
Voltage deviation (transient)	$\%V_{OUT_TRANS}$	Minimum C_{OUT_EXT} (10 \leftrightarrow 90% load step).		<10		%
Settling time	t_{SETTLE}			14.0		ms
Powertrain Protections						
Input Voltage Initialization threshold	V_{IN_INIT}	Threshold to start t_{INIT} delay			6	V
Input Voltage Reset threshold	V_{IN_RESET}	Latching faults will clear once V_{IN} falls below V_{IN_RESET}	3			V
Input undervoltage lockout threshold	V_{IN_UVLO-}		25.80		40.85	V
Input undervoltage recovery threshold	V_{IN_UVLO+}	See Timing diagram			43.00	V
Input overvoltage lockout threshold	V_{IN_OVLO+}				171	V
Input overvoltage recovery threshold	V_{IN_OVLO-}	See Timing diagram	154			V
Output overvoltage threshold	V_{OUT_OVP}	From 25% to 100% load. Latched shutdown	60.72			V
Output overvoltage threshold	$V_{OUT_OVP_LL}$	From 0% to 25% load. Latched shutdown	63.36			V
Minimum current limited V_{OUT}	V_{OUT_UVP}	Over all operating steady-state line and trim conditions			21.60	V
Overtemperature threshold (internal)	T_{INT_OTP}		125			$^{\circ}\text{C}$
Power limit	P_{LIM}				500	W
V_{IN} overvoltage to cessation of powertrain switching	t_{OVLO_SW}	Independent of fault logic		2.4		μs
V_{IN} overvoltage response time	t_{OVLO}	For fault logic only			200	μs
V_{IN} undervoltage response time	t_{UVLO}				100	ms
Short circuit response time	t_{SC}	Powertrain on, operational state			200	μs
Short circuit, or temperature fault recovery time	t_{FAULT}	See Timing diagram		1		s

Signal Specifications

Specifications apply over all line, trim and load conditions, internal temperature $T_{INT} = 25^{\circ}\text{C}$, unless otherwise noted. **Boldface** specifications apply over the temperature range of $-40^{\circ}\text{C} < T_{INT} < 125^{\circ}\text{C}$ for T grade and $-55^{\circ}\text{C} < T_{INT} < 125^{\circ}\text{C}$ for M grade.

Enable: EN

- The EN pin enables and disables the DCM converter; when held low the unit will be disabled.
- The EN pin has an internal pull-up to V_{CC} and is referenced to the -IN pin of the converter.

SIGNAL TYPE	STATE	ATTRIBUTE	SYMBOL	CONDITIONS / NOTES	MIN	NOM	MAX	UNIT
DIGITAL INPUT	Any	EN enable threshold	$V_{ENABLE-EN}$				2.31	V
		EN disable threshold	$V_{ENABLE-DIS}$		0.99			V
		Internally generated V_{CC}	V_{CC}		3.21	3.30	3.39	V
		EN internal pull up resistance to V_{CC}	$R_{ENABLE-INT}$		9.9	10.0	10.1	k Ω

Trim: TR

- The TR pin enables and disables trim functionality when V_{IN} is initially applied to the DCM converter. When V_{IN} first crosses $V_{IN-UVLO+}$, the voltage on TR determines whether or not trim is active.
- If TR is not floating at power up and has a voltage less than TR trim enable threshold, trim is active.
- If trim is active, the TR pin provides dynamic trim control with at least 30Hz of -3dB control bandwidth over the output voltage of the DCM converter.
- The TR pin has an internal pull-up to V_{CC} and is referenced to the -IN pin of the converter.

SIGNAL TYPE	STATE	ATTRIBUTE	SYMBOL	CONDITIONS / NOTES	MIN	NOM	MAX	UNIT
DIGITAL INPUT	Startup	TR trim disable threshold	$V_{TRIM-DIS}$	Trim disabled when TR above this threshold at power up			3.20	V
		TR trim enable threshold	$V_{TRIM-EN}$	Trim enabled when TR below this threshold at power up	3.15			V
ANALOG INPUT	Operational with Trim enabled	Internally generated V_{CC}	V_{CC}		3.21	3.30	3.39	V
		TR pin functional range	$V_{TRIM-RANGE}$		0.00	2.44	3.16	V
		V_{OUT} referred TR pin resolution	$V_{OUT-RES}$	With $V_{CC} = 3.3\text{ V}$			62	mV
		TR internal pull up resistance to V_{CC}	$R_{TRIM-INT}$		9.9	10.0	10.1	k Ω

Fault: FT

- The FT pin is a Fault flag pin.
- When the module is enabled and no fault is present, the FT pin does not have current drive capability.
- Whenever the powertrain stops (due to a fault protection or disabling the module by pulling EN low), the FT pin output V_{CC} and provides current to drive an external circuit.
- When module starts up, the FT pin is pulled high to V_{CC} during microcontroller initialization and will remain high until soft start process starts.

SIGNAL TYPE	STATE	ATTRIBUTE	SYMBOL	CONDITIONS / NOTES	MIN	NOM	MAX	UNIT
DIGITAL OUTPUT	Any	FT internal pull up resistance to V_{CC}	$R_{FAULT-INT}$		494	499	504	k Ω
	FT Active	FT voltage	$V_{FAULT-ACTIVE}$	At rated current drive capability	3.0			V
		FT current drive capability	$I_{FAULT-ACTIVE}$	Over-load beyond the ABSOLUTE MAXIMUM ratings may cause module damage	4			mA
		FT response time	$t_{FT-ACTIVE}$	Delay from cessation of switching to FT Pin Active			200	μs

High Level Functional State Diagram

Conditions that cause state transitions are shown along arrows. Sub-sequence activities listed inside the state bubbles.



Timing Diagrams

Module Inputs are shown in blue; Module Outputs are shown in brown.

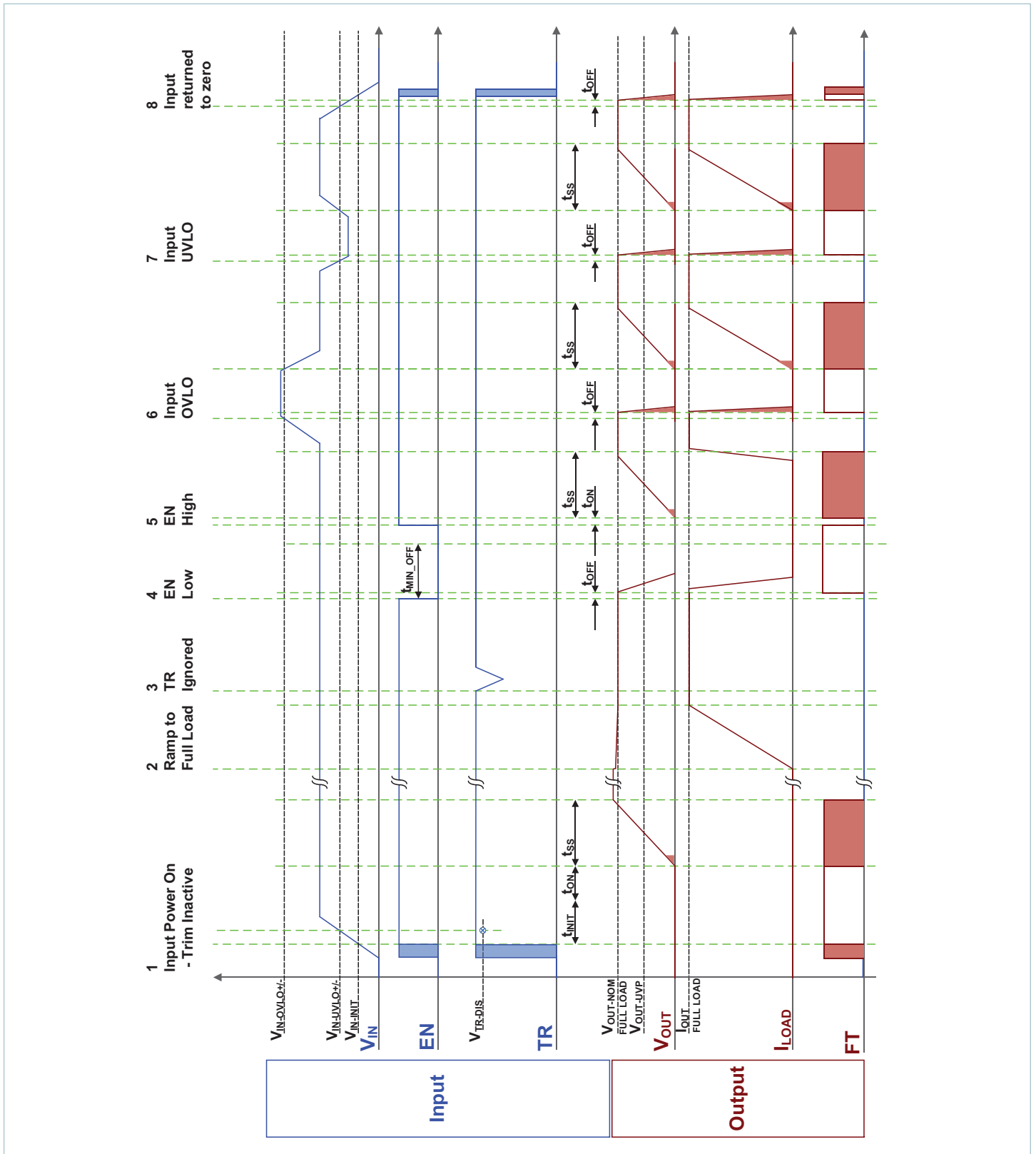

Timing Diagrams (Cont.)

Module Inputs are shown in blue; Module Outputs are shown in brown.

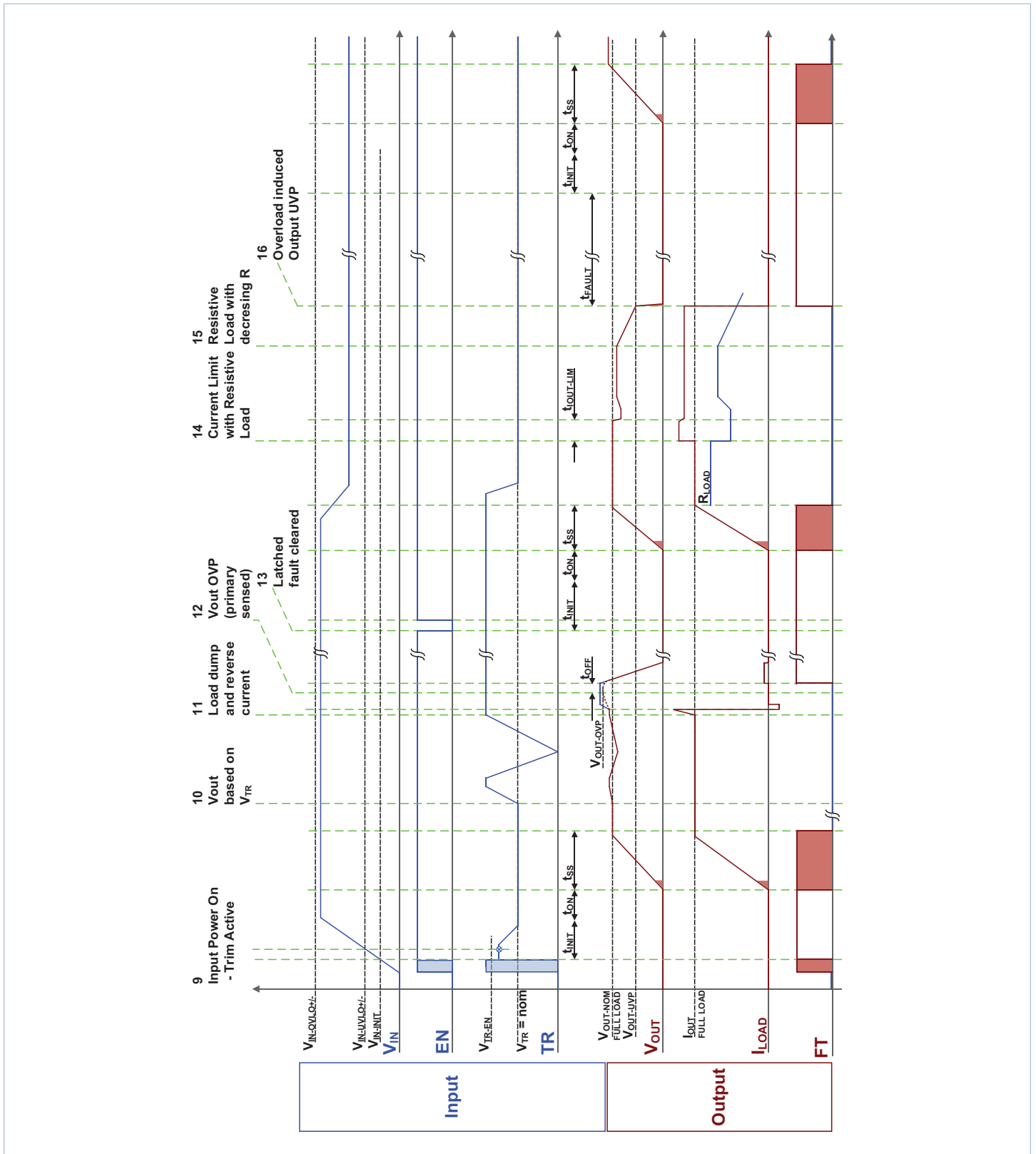

Typical Performance Characteristics

The following figures present typical performance at $T_C = 25^\circ\text{C}$, unless otherwise noted. See associated figures for general trend data.

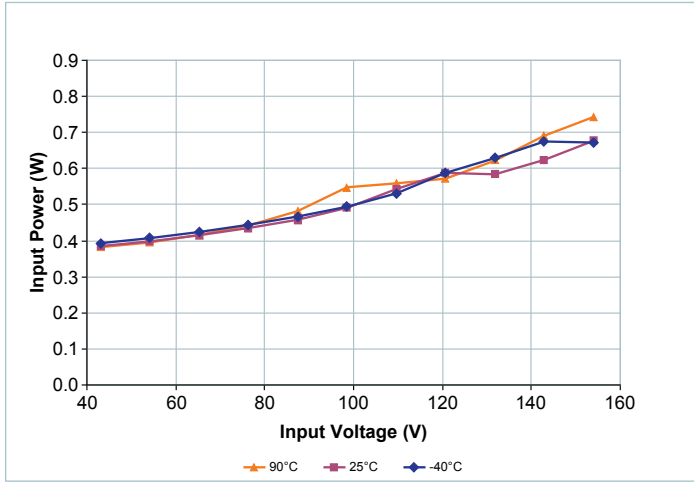

Figure 3 — Disabled power dissipation vs. V_{IN}

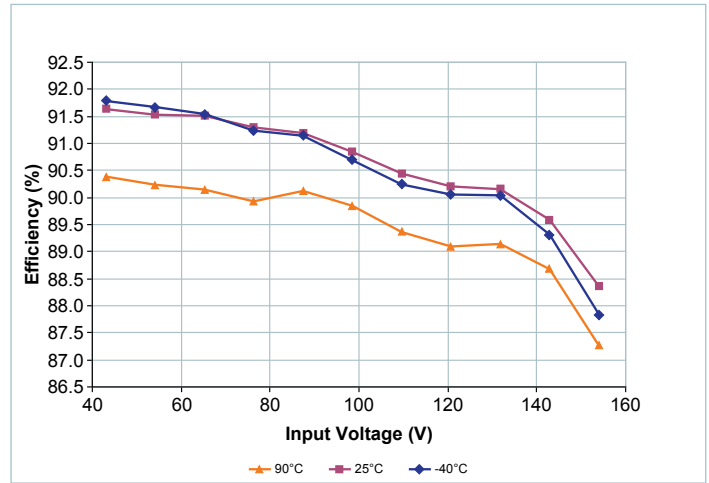

Figure 6 — Full Load Efficiency vs. V_{IN} , at low trim

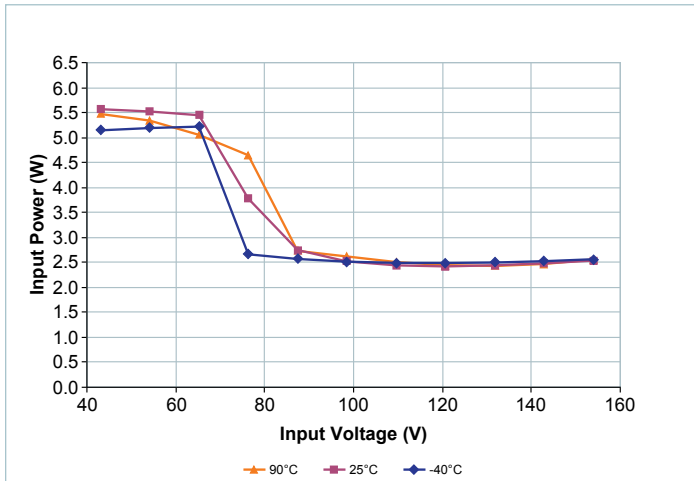

Figure 4 — No load power dissipation vs. V_{IN} , at nominal trim

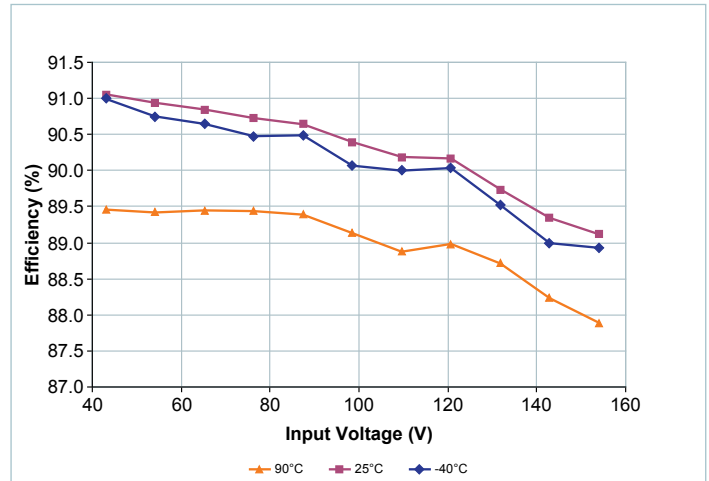

Figure 7 — Full Load Efficiency vs. V_{IN} , at nominal trim

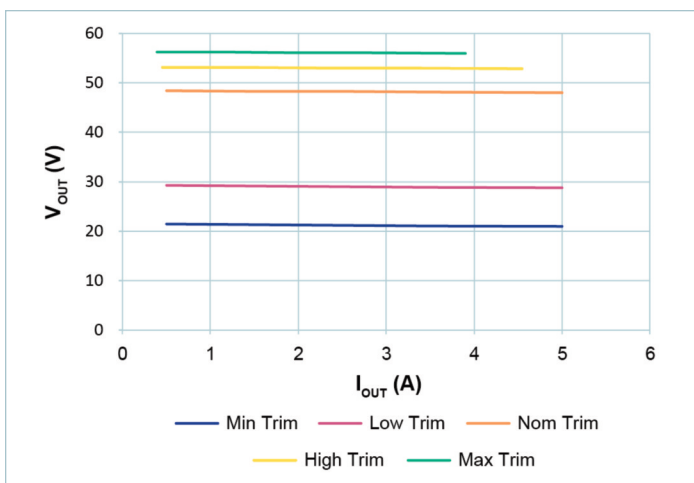

Figure 5 — Ideal V_{OUT} vs. load current, at 25°C case

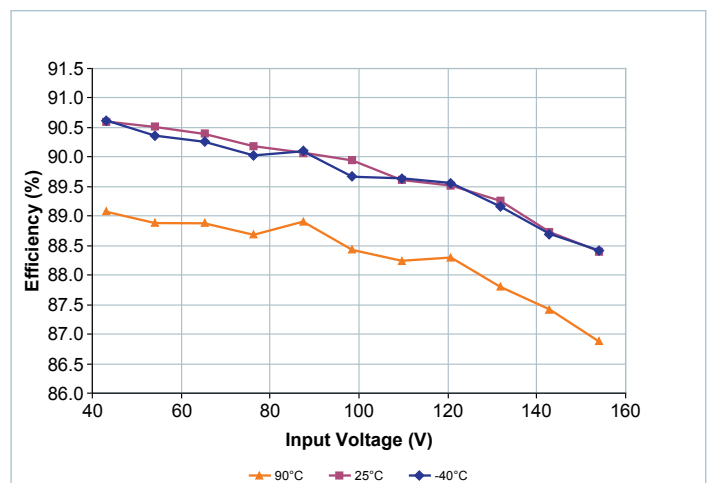

Figure 8 — Full Load Efficiency vs. V_{IN} , at high trim

Typical Performance Characteristics (cont.)

The following figures present typical performance at $T_C = 25^\circ\text{C}$, unless otherwise noted. See associated figures for general trend data.

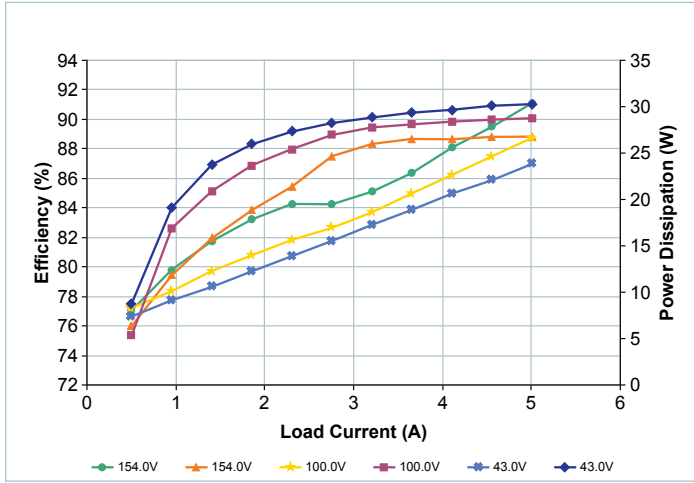

Figure 9 — Efficiency and power dissipation vs. load at $T_{CASE} = -40^\circ\text{C}$, nominal trim

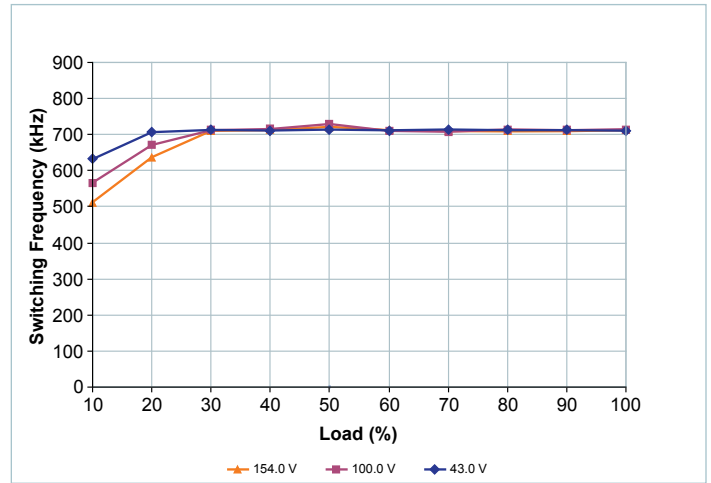

Figure 12 — Nominal powertrain switching frequency vs. load, at nominal trim

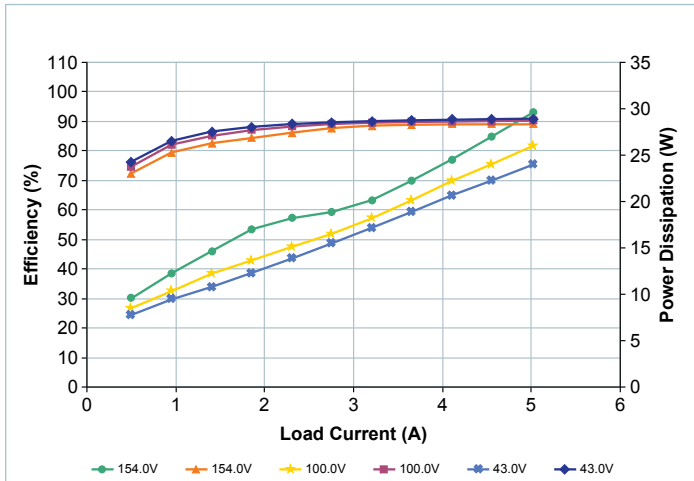

Figure 10 — Efficiency and power dissipation vs. load at $T_{CASE} = 25^\circ\text{C}$, nominal trim

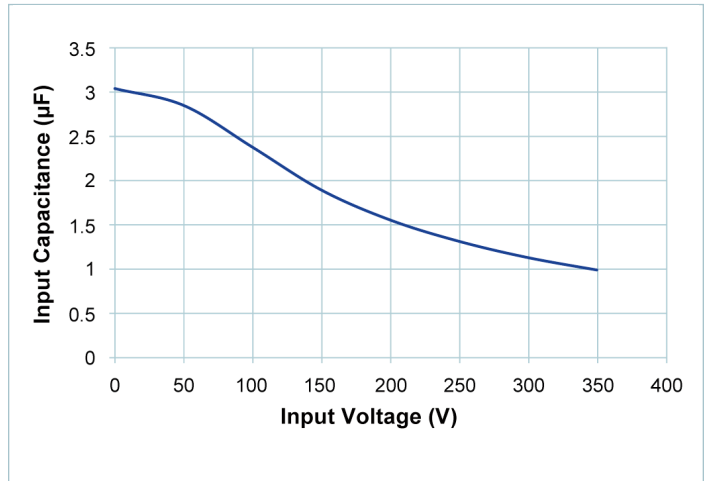

Figure 13 — Effective internal input capacitance vs. applied voltage

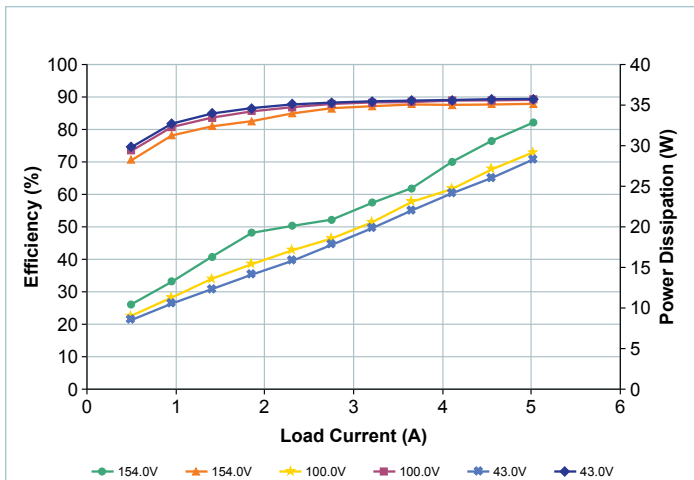

Figure 11 — Efficiency and power dissipation vs. load at $T_{CASE} = 90^\circ\text{C}$, nominal trim

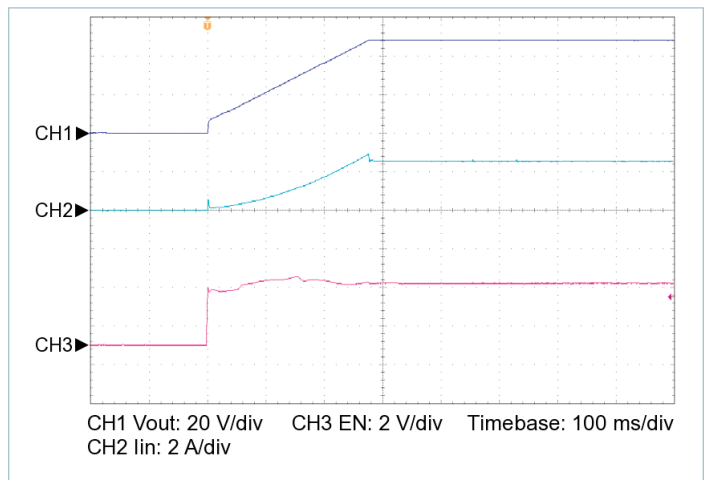

Figure 14 — Startup from EN, $V_{IN} = 100\text{ V}$, $C_{OUT_EXT} = 4000\ \mu\text{F}$, $R_{LOAD} = 9.600\ \Omega$

Typical Performance Characteristics (cont.)

The following figures present typical performance at $T_C = 25^\circ\text{C}$, unless otherwise noted. See associated figures for general trend data.

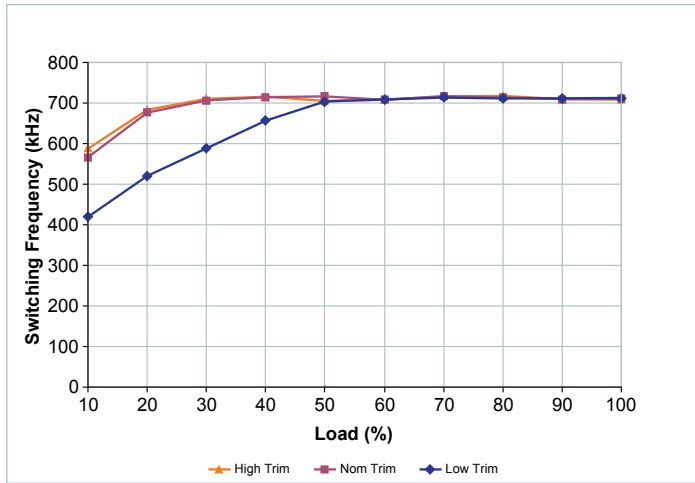

Figure 15 — Nominal powertrain switching frequency vs. load, at nominal V_{IN}

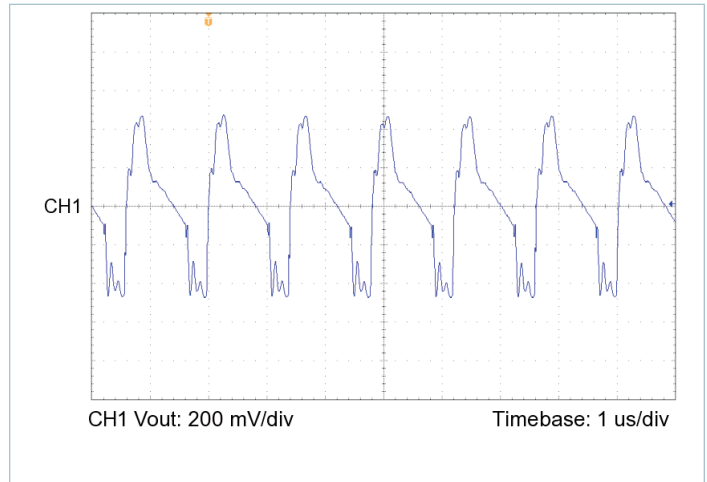

Figure 16 — Output voltage ripple, $V_{IN} = 100\text{ V}$, $V_{OUT} = 48.0\text{ V}$, $C_{OUT_EXT} = 200\ \mu\text{F}$, $R_{LOAD} = 9.600\ \Omega$

General Characteristics

Specifications apply over all line, trim and load conditions, internal temperature $T_{INT} = 25^{\circ}\text{C}$, unless otherwise noted. **Boldface** specifications apply over the temperature range of $-40^{\circ}\text{C} < T_{INT} < 125^{\circ}\text{C}$ for T grade and $-55^{\circ}\text{C} < T_{INT} < 125^{\circ}\text{C}$ for M grade.

Attribute	Symbol	Conditions / Notes	Min	Typ	Max	Unit
Mechanical						
Length	L		38.34/[1.509]	38.72/[1.524]	39.1/[1.539]	mm/[in]
Width	W		22.67/[0.893]	22.8/[0.898]	22.93/[0.903]	mm/[in]
Height	H		7.11/[0.28]	7.21/[0.284]	7.31/[0.288]	mm/[in]
Volume	Vol	No heat sink		6.41/[0.39]		cm ³ /[in ³]
Weight	W			24.0/[0.85]		g/[oz]
Lead finish		Nickel	0.51		2.03	μm
		Palladium	0.02		0.15	
		Gold	0.003		0.051	
Thermal						
Operating internal temperature	T_{INT}	T-Grade	-40		125	°C
		M-Grade	-55		125	°C
Thermal resistance top side	$\theta_{INT-TOP}$	Estimated thermal resistance to maximum temperature internal component from isothermal top		2.50		°C/W
Thermal resistance leads	$\theta_{INT-LEADS}$	Estimated thermal resistance to maximum temperature internal component from isothermal leads		4.20		°C/W
Thermal resistance bottom side	$\theta_{INT-BOTTOM}$	Estimated thermal resistance to maximum temperature internal component from isothermal bottom		2.50		°C/W
Thermal capacity				17.7		Ws/°C
Assembly						
Storage temperature	T_{ST}	T-Grade	-40		125	°C
		M-Grade	-65		125	°C
ESD rating	HBM	Method per Human Body Model Test ESDA/JEDEC JDS-001-2012	CLASS 1C			V
	CDM	Charged Device Model JESD22-C101E	CLASS 2			
Soldering ^[1]						
Peak temperature top case		For further information, please contact factory applications			135	°C

^[1] Product is not intended for reflow solder attach.

General Characteristics (Cont.)

Specifications apply over all line, trim and load conditions, internal temperature $T_{INT} = 25^{\circ}\text{C}$, unless otherwise noted. **Boldface** specifications apply over the temperature range of $-40^{\circ}\text{C} < T_{INT} < 125^{\circ}\text{C}$ for T grade and $-55^{\circ}\text{C} < T_{INT} < 125^{\circ}\text{C}$ for M grade.

Attribute	Symbol	Conditions / Notes	Min	Typ	Max	Unit
Safety						
Dielectric Withstand Test	V_{HIPO}	IN to OUT	3000			Vdc
		IN to CASE	1500			Vdc
		OUT to CASE	1500			Vdc
Reliability						
MTBF		MIL-HDBK-217 FN2 Parts Count 25°C Ground Benign, Stationary, Indoors / Computer		3.39		MHrs
		Telcordia Issue 2, Method I Case 3, 25°C , 100% D.C., GB, GC		5.68		MHrs
Agency Approvals						
Agency approvals/standards						
		CE Marked for Low Voltage Directive and RoHS Recast Directive, as applicable				

Pin Functions

+IN, -IN

Input power pins. -IN is the reference for all control pins, and therefore a Kelvin connection for the control signals is recommended as close as possible to the pin on the package, to reduce effects of voltage drop due to -IN currents.

+OUT, -OUT

Output power pins.

EN (Enable)

This pin enables and disables the DCM converter; when held low the unit will be disabled. It is referenced to the -IN pin of the converter. The EN pin has an internal pull-up to V_{CC} through a 10 k Ω resistor.

- Output enable: When EN is allowed to pull up above the enable threshold, the module will be enabled. If leaving EN floating, it is pulled up to V_{CC} and the module will be enabled.
- Output disable: EN may be pulled down externally in order to disable the module.
- EN is an input only, it does not pull low in the event of a fault.

TR (Trim)

The TR pin is used to select the trim mode and to trim the output voltage of the DCM converter. The TR pin has an internal pull-up to V_{CC} through a 10.0 k Ω resistor.

The DCM will latch trim behavior at application of V_{IN} (once V_{IN} exceeds $V_{IN-UVLO+}$), and persist in that same behavior until loss of input voltage.

- At application of V_{IN} , if TR is sampled at above $V_{TRIM-DIS}$, the module will latch in a non-trim mode, and will ignore the TR input for as long as V_{IN} is present.
- At application of V_{IN} , if TR is sampled at below $V_{TRIM-EN}$, the TR will serve as an input to control the real time output voltage. It will persist in this behavior until V_{IN} is no longer present.

If trim is active when the DCM is operating, the TR pin provides dynamic trim control at a typical 30 Hz of -3dB bandwidth over the output voltage. TR also decreases the current limit threshold when trimming above $V_{OUT-NOM}$.

FT (Fault)

The FT pin provides a Fault signal.

Anytime the module is enabled and has not recognized a fault, the FT pin is inactive. FT has an internal 499 k Ω pull-up to V_{CC} , therefore a shunt resistor, R_{SHUNT} , of approximately 50 k Ω can be used to ensure the LED is completely off when there is no fault, per the diagram below.

Whenever the powertrain stops (due to a fault protection or disabling the module by pulling EN low), the FT pin becomes active and provides current to drive an external circuit.

When active, FT pin drives to V_{CC} , with up to 4 mA of external loading. Module may be damaged from an over-current FT drive, thus a resistor in series for current limiting is recommended.

The FT pin becomes active momentarily when the module starts up.

Typical External Circuits for Signal Pins (TR, EN, FT)

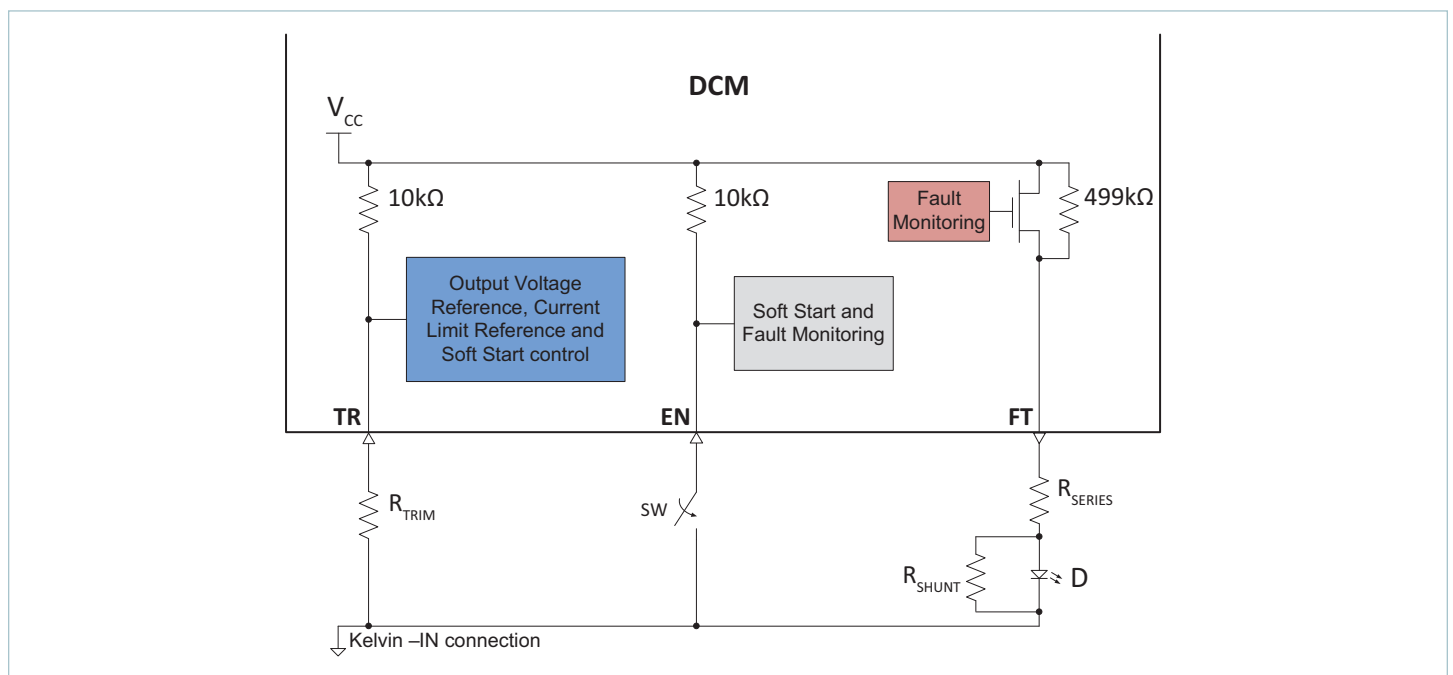

Design Guidelines

Building Blocks and System Design

The DCM™ converter input accepts the full 43 to 154 V range, and it generates an isolated trimmable 48.0 Vdc output.

The DCM converter provides a tightly regulated output voltage; please refer to the Output Voltage Load Regulation specification in the Electrical Specifications table.

The DCM3623xA5N53B4y7z is designed to be used in applications where the output power requirements are up to 240 W.

Soft Start

When the DCM starts, it will go through a soft start. The soft start routine ramps the output voltage by modulating the internal error amplifier reference. This causes the output voltage to approximate a piecewise linear ramp. The output ramp finishes when the voltage reaches either the nominal output voltage, or the trimmed output voltage in cases where trim mode is active.

During soft-start, the maximum load current capability is reduced. Until V_{out} achieves at least $V_{OUT-FL-THRESH}$, the output current must be less than $I_{OUT-START}$ in order to guarantee startup. Note that this is current available to the load, above that which is required to charge the output capacitor.

Trim Mode and Output Trim Control

When the input voltage is initially applied to a DCM, and after t_{INIT} elapses, the trim pin voltage V_{TR} is sampled. The TR pin has an internal pull up resistor to V_{CC} , so unless external circuitry pulls the pin voltage lower, it will pull up to V_{CC} . If the initially sampled trim pin voltage is higher than $V_{TRIM-DIS}$, then the DCM will disable trimming as long as the V_{IN} remains applied. In this case, for all subsequent operation the output voltage will be programmed to the nominal. This minimizes the support components required for applications that only require the nominal rated V_{out} , and also provides the best output setpoint accuracy, as there are no additional errors from external trim components.

If at initial application of V_{IN} , the TR pin voltage is prevented from exceeding $V_{TRIM-EN}$, then the DCM will activate trim mode, and it will remain active for as long as V_{IN} is applied.

V_{OUT} set point can be calculated using the equation below:

$$V_{OUT-FL} = 20.9971 + (36.4701 \cdot V_{TR}/V_{CC}) \quad (1)$$

Or using the online tool, DCM Trim Calculator, find the value of V_{TR} or trim resistor to set the desired V_{OUT} :

<http://www.vicorpower.com/calculators>

Note that the trim mode is not changed when a DCM recovers from any fault condition or being disabled.

Module performance is guaranteed through output voltage trim range $V_{OUT-TRIMMING}$. If V_{OUT} is trimmed above this range, then certain combinations of line and load transient conditions may trigger the output OVP.

Overall Output Voltage Transfer Function

Taking trim (equation 1) into account, the general equation relating the DC V_{OUT} to programmed trim (when active), load is given by:

$$V_{OUT} = 20.9971 + (36.4701 \cdot V_{TR}/V_{CC}) + \Delta V_{OUT-LL} \quad (2)$$

Finally, note that when the load current is below 10% of the rated capacity, there is an additional ΔV which may add to the output voltage, depending on the line voltage which is related to light load boosting. Please see the section on light load boosting below for details.

Use 0 V for ΔV_{OUT-LL} when load is above 10% of rated load. See section on light load boosting operation for light load effects on output voltage.

Output Current Limit

The DCM features a fully operational current limit which effectively keeps the module operating inside the Safe Operating Area (SOA) for all valid trim and load profiles. The current limit approximates a “brick wall” limit, where the output current is prevented from exceeding the current limit threshold by reducing the output voltage via the internal error amplifier reference. The current limit threshold at nominal trim and below is typically 120% of rated output current, but it can vary between 100% to 135%. In order to preserve the SOA, when the converter is trimmed above the nominal output voltage, the current limit threshold is automatically reduced to limit the available output power.

When the output current exceeds the current limit threshold, current limit action is held off by 1ms, which permits the DCM to momentarily deliver higher peak output currents to the load. Peak output power during this time is still constrained by the internal Power Limit of the module. The fast Power Limit and relatively slow Current Limit work together to keep the module inside the SOA. Delaying entry into current limit also permits the DCM to minimize droop voltage for load steps.

Sustained operation in current limit is permitted, and no derating of output power is required.

Some applications may benefit from well matched current distribution, in which case fine tuning sharing via the trim pins permits control over sharing. The DCM does not require this for proper operation, due to the power limit and current limit behaviors described here.

Current limit can reduce the output voltage to as little as the UVP threshold ($V_{OUT-UVF}$). Below this minimum output voltage compliance level, further loading will cause the module to shut down due to the output undervoltage fault protection.

Line Impedance, Input Slew rate and Input Stability Requirements

Connect a high-quality, low-noise power supply to the +IN and -IN terminals. Additional capacitance may have to be added between +IN and -IN to make up for impedances in the interconnect cables as well as deficiencies in the source.

Excessive source impedance can bring about system stability issues for a regulated DC-DC converter, and must either be avoided or compensated by filtering components. A 1000 μ F input capacitor is the minimum recommended in case the source impedance is insufficient to satisfy stability requirements.

Additional information can be found in the filter design application note:

www.vicorpower.com/documents/application_notes/vichip_appnote23.pdf

Please refer to this input filter design tool to ensure input stability: <http://app2.vicorpower.com/filterDesign/intiFilter.do>.

Ensure that the input voltage slew rate is less than 1V/us, otherwise a pre-charge circuit is required for the DCM input to control the input voltage slew rate and prevent overstress to input stage components.

Input Fuse Selection

The DCM is not internally fused in order to provide flexibility in configuring power systems. Input line fusing is recommended at the system level, in order to provide thermal protection in case of catastrophic failure. The fuse shall be selected by closely matching system requirements with the following characteristics:

- Current rating (usually greater than the DCM converter's maximum current)
- Maximum voltage rating (usually greater than the maximum possible input voltage)
- Ambient temperature
- Breaking capacity per application requirements
- Nominal melting I^2t
- Recommended fuse: See Agency Approvals for Recommended Fuse <http://www.vicorpower.com/dc-dc/isolated-regulated/dcm#Documentation>

Fault Handling

Input Undervoltage Fault Protection (UVLO)

The converter's input voltage is monitored to detect an input under voltage condition. If the converter is not already running, then it will ignore enable commands until the input voltage is greater than $V_{IN-UVLO+}$. If the converter is running and the input voltage falls below $V_{IN-UVLO-}$, the converter recognizes a fault condition, the powertrain stops switching, and the output voltage of the unit falls.

Input voltage transients which fall below UVLO for less than t_{UVLO} may not be detected by the fault protection logic, in which case the converter will continue regular operation. No protection is required in this case.

Once the UVLO fault is detected by the fault protection logic, the converter shuts down and waits for the input voltage to rise above $V_{IN-UVLO+}$. Provided the converter is still enabled, it will then restart.

Input Overvoltage Fault Protection (OVLO)

The converter's input voltage is monitored to detect an input over voltage condition. When the input voltage is more than the $V_{IN-OVLO+}$, a fault is detected, the powertrain stops switching, and the output voltage of the converter falls.

After an OVLO fault occurs, the converter will wait for the input voltage to fall below $V_{IN-OVLO-}$. Provided the converter is still enabled, the powertrain will restart.

The powertrain controller itself also monitors the input voltage. Transient OVLO events which have not yet been detected by the fault sequence logic may first be detected by the controller if the input slew rate is sufficiently large. In this case, powertrain switching will immediately stop. If the input voltage falls back in range before the fault sequence logic detects the out of range condition, the powertrain will resume switching and the fault logic will not interrupt operation. Regardless of whether the powertrain is running at the time or not, if the input voltage does not recover from OVLO before t_{OVLO} , the converter fault logic will detect the fault.

Output Undervoltage Fault Protection (UVP)

The converter determines that an output overload or short circuit condition exists by measuring its primary sensed output voltage and the output of the internal error amplifier. In general, whenever the powertrain is switching and the primary-sensed output voltage falls below $V_{OUT-UVP}$ threshold, a short circuit fault will be registered. Once an output undervoltage condition is detected, the powertrain immediately stops switching, and the output voltage of the converter

falls. The converter remains disabled for a time t_{FAULT} . Once recovered and provided the converter is still enabled, the powertrain will again enter the soft start sequence after t_{INIT} and t_{ON} .

Temperature Fault Protections (OTP)

The fault logic monitors the internal temperature of the converter. If the measured temperature exceeds $T_{INT-OTP}$, a temperature fault is registered. As with the under voltage fault protection, once a temperature fault is registered, the powertrain immediately stops switching, the output voltage of the converter falls, and the converter remains disabled for at least time t_{FAULT} . Then, the converter waits for the internal temperature to return to below $T_{INT-OTP}$ before recovering. Provided the converter is still enabled, the DCM will restart after t_{INIT} and t_{ON} .

Output Overvoltage Fault Protection (OVP)

The converter monitors the output voltage during each switching cycle by a corresponding voltage reflected to the primary side control circuitry. If the primary sensed output voltage exceeds $V_{OUT-OVP}$, the OVP fault protection is triggered. The control logic disables the powertrain, and the output voltage of the converter falls.

This type of fault is latched, and the converter will not start again until the latch is cleared. Clearing the fault latch is achieved by either disabling the converter via the EN pin, or else by removing the input power such that the input voltage falls below $V_{IN-INIT}$.

External Output Capacitance

The DCM converter internal compensation requires a minimum external output capacitor. An external capacitor in the range of 200 to 4000 μF with ESR of 10 m Ω is required, per DCM for control loop compensation purposes.

However some DCM models require an increase to the minimum external output capacitor value in certain loading and trim condition. In applications where the load can go below 10% of rated load but the output trim is held constant, the range of output capacitor required is given by $C_{OUT-EXT-TRANS}$ in the Electrical Specifications table. If the load can go below 10% of rated load and the DCM output trim is also dynamically varied, the range of output capacitor required is given by $C_{OUT-EXT-TRANS-TRIM}$ in the Electrical Specifications table.

Light Load Boosting

Under light load conditions, the DCM converter may operate in light load boosting depending on the line voltage. Light load boosting occurs whenever the internal power consumption of the converter combined with the external output load is less than the minimum power transfer per switching cycle. In order to maintain regulation, the error amplifier will switch the powertrain off and on repeatedly, to effectively lower the average switching frequency, and permit operation with no external load. During the time when the power train is off, the module internal consumption is significantly reduced, and so there is a notable reduction in no-load input power in light load boosting. When the load is less than 10% of rated I_{out} , the output voltage may rise by a maximum of 2.31 V, above the output voltage calculated from trim, temperature, and load line conditions.

Thermal Design

Based on the safe thermal operating area shown in page 5, the full rated power of the DCM3623xA5N53B4y7z can be processed provided that the top, bottom, and leads are all held below 96°C. These curves highlight the benefits of dual sided thermal management, but also demonstrate the flexibility of the Vicor ChiP platform for customers who are limited to cooling only the top or the bottom surface.

The OTP sensor is located on the top side of the internal PCB structure. Therefore in order to ensure effective over-temperature fault protection, the case bottom temperature must be constrained by the thermal solution such that it does not exceed the temperature of the case top.

The ChiP package provides a high degree of flexibility in that it presents three pathways to remove heat from internal power dissipating components. Heat may be removed from the top surface, the bottom surface and the leads. The extent to which these three surfaces are cooled is a key component for determining the maximum power that is available from a ChiP, as can be seen from Figure 17.

Since the ChiP has a maximum internal temperature rating, it is necessary to estimate this internal temperature based on a real thermal solution. Given that there are three pathways to remove heat from the ChiP, it is helpful to simplify the thermal solution into a roughly equivalent circuit where power dissipation is modeled as a current source, isothermal surface temperatures are represented as voltage sources and the thermal resistances are represented as resistors. Figure 17 shows the "thermal circuit" for a 3623 ChiP DCM, in an application where both case top and case bottom, and leads are cooled. In this case, the DCM power dissipation is PD_{TOTAL} and the three surface temperatures are represented as T_{CASE_TOP}, T_{CASE_BOTTOM}, and T_{LEADS}. This thermal system can now be very easily analyzed with simple resistors, voltage sources, and a current source.

This analysis provides an estimate of heat flow through the various pathways as well as internal temperature.



Figure 17 — Double side cooling and leads thermal model

Alternatively, equations can be written around this circuit and analyzed algebraically:

$$T_{INT} - PD_1 \cdot \theta_{INT-TOP} = T_{CASE_TOP}$$

$$T_{INT} - PD_2 \cdot \theta_{INT-BOTTOM} = T_{CASE_BOTTOM}$$

$$T_{INT} - PD_3 \cdot \theta_{INT-LEADS} = T_{LEADS}$$

$$PD_{TOTAL} = PD_1 + PD_2 + PD_3$$

Where T_{INT} represents the internal temperature and PD₁, PD₂, and PD₃ represent the heat flow through the top side, bottom side, and leads respectively.



Figure 18 — One side cooling and leads thermal model

Figure 18 shows a scenario where there is no bottom side cooling. In this case, the heat flow path to the bottom is left open and the equations now simplify to:

$$T_{INT} - PD_1 \cdot \theta_{INT-TOP} = T_{CASE_TOP}$$

$$T_{INT} - PD_3 \cdot \theta_{INT-LEADS} = T_{LEADS}$$

$$PD_{TOTAL} = PD_1 + PD_3$$



Figure 19 — One side cooling thermal model

Figure 19 shows a scenario where there is no bottom side and leads cooling. In this case, the heat flow path to the bottom is left open and the equations now simplify to:

$$T_{INT} - PD_1 \cdot \theta_{INT-TOP} = T_{CASE_TOP}$$

$$PD_{TOTAL} = PD_1$$

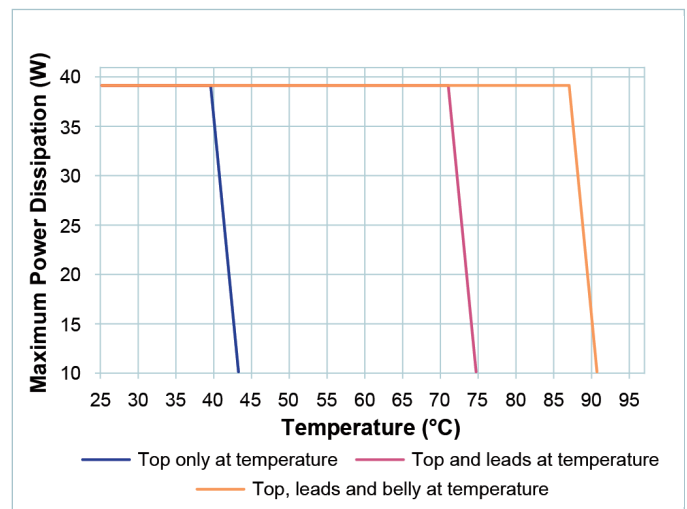

Figure 20 — Thermal Specified Operating Area: Max Power Dissipation vs. Case Temp for current limited operation

Vicor provides a suite of online tools, including a simulator and thermal estimator which greatly simplify the task of determining whether or not a DCM thermal configuration is sufficient for a given condition. These tools can be found at: www.vicorpower.com/powerbench.

DCMs in current limit will operate with higher output current or power than the rated levels. Therefore the Figure 20 Thermal Safe Operating Area plot should be used for loads that drive the DCM in to current limit for sustained operation.

Standalone Operation

The following Figure 21 shows the configuration of the Enhanced V_{OUT} DCM. An input filter is required to attenuate noise coming from the input source. In case of the excessive line inductance, a properly sized decoupling capacitor $C_{DECOUPLE}$ is required as shown in the following figure.

If signal pins (TR, EN, FT) are not used, they can be left floating, and DCM will work in the nominal output condition.

When common mode noise in the input side is not a concern, TR and EN can be driven and FT received using -IN as a reference.

L1: 1 μ H, minimized DCR;

R1: 1.0 Ω ;

C1: Ceramic capacitors in parallel, $C1 = 2 \mu$ F;

L2: $L2 \geq 0.15 \mu$ H;

R2: 1 Ω ;

C_{OUT-EXT}: electrolytic or tantalum capacitor, 200μ F $\leq C3 \leq 4000 \mu$ F;

C4, C5: additional ceramic /electrolytic capacitors, if needed for output ripple filtering;

In order to help sensitive signal circuits reject potential noise, additional components are recommended:

R5: 301 Ω , facilitate noise attenuation for TR pin;

FB1, C2: FB1 is a ferrite bead with an impedance of at least 10 Ω at 100MHz. **C2** can be a ceramic capacitor of 0.1 μ F. Facilitate noise attenuation for EN pin.

Note: Use an RCR filter network as suggested in the application note AN:030 to reduce the noise on the signal pins.

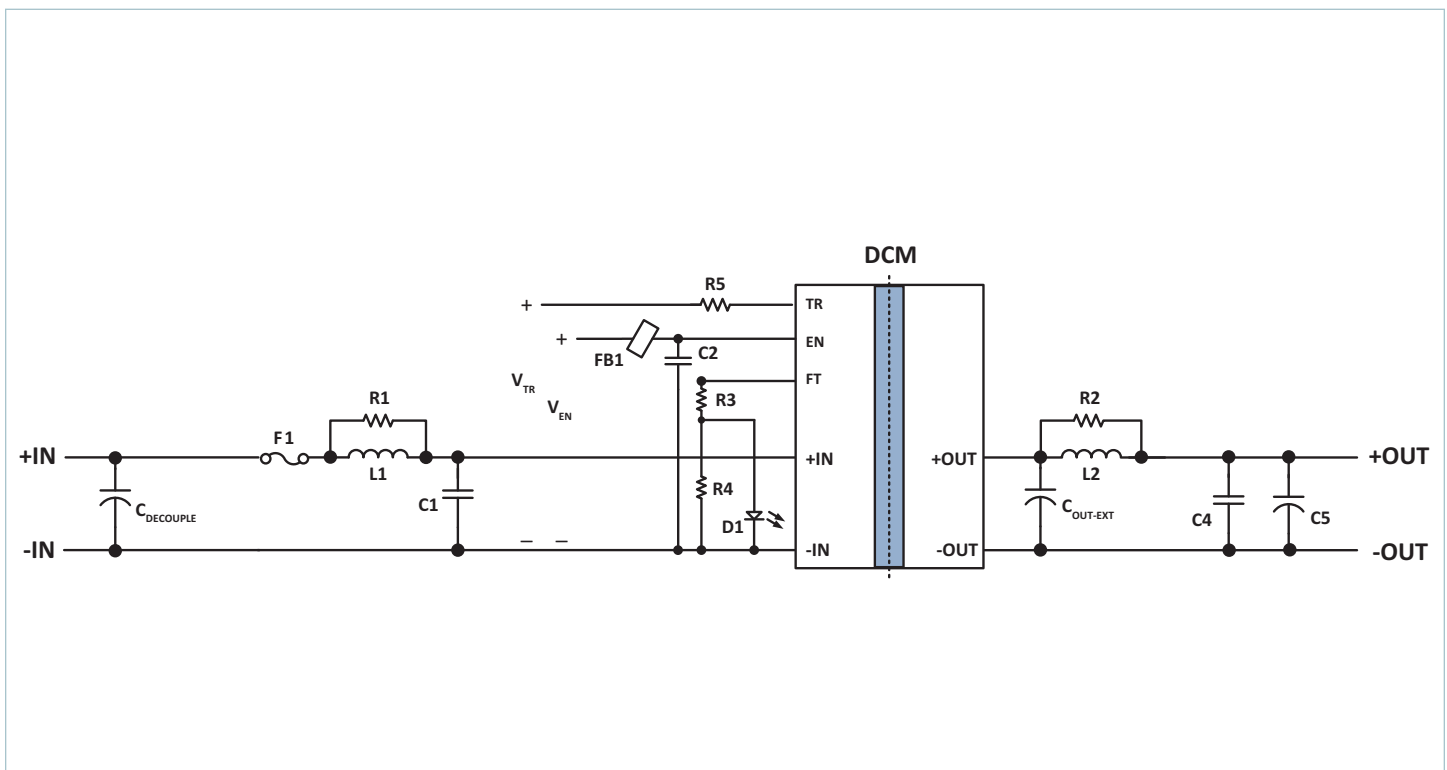
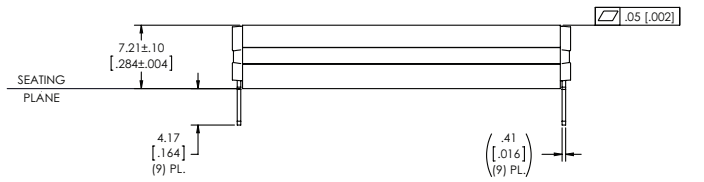

Figure 21 — Enhanced V_{OUT} DCM configuration circuit

DCM Module Product Outline Drawing Recommended PCB Footprint and Pinout



TOP VIEW (COMPONENT SIDE)



BOTTOM VIEW

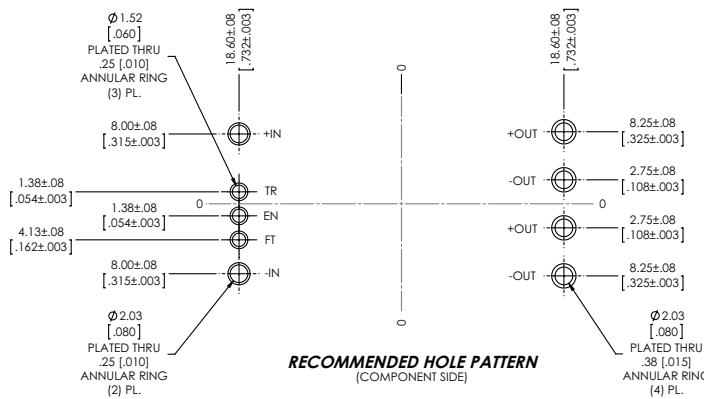

RECOMMENDED HOLE PATTERN (COMPONENT SIDE)

NOTES:
1- RoHS COMPLIANT PER CST-0001 LATEST REVISION.

Revision History

Revision	Date	Description	Page Number(s)
1.0	11/28/17	Initial release	n/a
1.1	01/28/20	Updated typical applications Output voltage regulation specification format change Updated state and timing diagrams Updated figure 5 Corrected figure 16 to match internal capacitance Updated Trim descriptions and typical external circuits diagram	2 5 8 – 10 11 12 16, 17

Vicor's comprehensive line of power solutions includes high density AC-DC and DC-DC modules and accessory components, fully configurable AC-DC and DC-DC power supplies, and complete custom power systems.

Information furnished by Vicor is believed to be accurate and reliable. However, no responsibility is assumed by Vicor for its use. Vicor makes no representations or warranties with respect to the accuracy or completeness of the contents of this publication. Vicor reserves the right to make changes to any products, specifications, and product descriptions at any time without notice. Information published by Vicor has been checked and is believed to be accurate at the time it was printed; however, Vicor assumes no responsibility for inaccuracies. Testing and other quality controls are used to the extent Vicor deems necessary to support Vicor's product warranty. Except where mandated by government requirements, testing of all parameters of each product is not necessarily performed.

Specifications are subject to change without notice.

Visit <http://www.vicorpower.com/dc-dc/isolated-regulated/dcm> for the latest product information.

Vicor's Standard Terms and Conditions and Product Warranty

All sales are subject to Vicor's Standard Terms and Conditions of Sale, and Product Warranty which are available on Vicor's webpage (<http://www.vicorpower.com/termsconditionswarranty>) or upon request.

Life Support Policy

VICOR'S PRODUCTS ARE NOT AUTHORIZED FOR USE AS CRITICAL COMPONENTS IN LIFE SUPPORT DEVICES OR SYSTEMS WITHOUT THE EXPRESS PRIOR WRITTEN APPROVAL OF THE CHIEF EXECUTIVE OFFICER AND GENERAL COUNSEL OF VICOR CORPORATION. As used herein, life support devices or systems are devices which (a) are intended for surgical implant into the body, or (b) support or sustain life and whose failure to perform when properly used in accordance with instructions for use provided in the labeling can be reasonably expected to result in a significant injury to the user. A critical component is any component in a life support device or system whose failure to perform can be reasonably expected to cause the failure of the life support device or system or to affect its safety or effectiveness. Per Vicor Terms and Conditions of Sale, the user of Vicor products and components in life support applications assumes all risks of such use and indemnifies Vicor against all liability and damages.

Intellectual Property Notice

Vicor and its subsidiaries own Intellectual Property (including issued U.S. and Foreign Patents and pending patent applications) relating to the products described in this data sheet. No license, whether express, implied, or arising by estoppel or otherwise, to any intellectual property rights is granted by this document. Interested parties should contact Vicor's Intellectual Property Department.

The products described on this data sheet are protected by the following U.S. Patents Numbers: RE40,072; 7,561,446; 7,920,391; 7,782,639; 8,427,269; 6,421,262 and other patents pending.

Contact Us: <http://www.vicorpower.com/contact-us>

Vicor Corporation
25 Frontage Road
Andover, MA, USA 01810
Tel: 800-735-6200
Fax: 978-475-6715
www.vicorpower.com

email

Customer Service: custserv@vicorpower.com
Technical Support: apps@vicorpower.com

©2017 – 2020 Vicor Corporation. All rights reserved. The Vicor name is a registered trademark of Vicor Corporation.
All other trademarks, product names, logos and brands are property of their respective owners.

X-ON Electronics

Largest Supplier of Electrical and Electronic Components

Click to view similar products for [Isolated DC/DC Converters](#) category:

Click to view products by [Vicor](#) manufacturer:

Other Similar products are found below :

[ESM6D044440C05AAQ](#) [FMD15.24G](#) [PSL486-7LR](#) [Q48T30020-NBB0](#) [JAHW100Y1](#) [SPB05C-12](#) [SQ24S15033-PS0S](#) [18952](#) [19-130041](#)
[CE-1003](#) [CE-1004](#) [GQ2541-7R](#) [RDS180245](#) [MAU228](#) [J80-0041NL](#) [DFC15U48D15](#) [XGS-0512](#) [XGS-1205](#) [XGS-1212](#) [XGS-2412](#) [XGS-](#)
[2415](#) [XKS-1215](#) [06322](#) [NCT1000N040R050B](#) [SPB05B-15](#) [SPB05C-15](#) [L-DA20](#) [DCG40-5G](#) [QME48T40033-PGB0](#) [XKS-2415](#) [XKS-2412](#)
[XKS-1212](#) [XKS-1205](#) [XKS-0515](#) [XKS-0505](#) [XGS-2405](#) [XGS-1215](#) [XGS-0515](#) [PS9Z-6RM4](#) [73-551-5038I](#) [AK1601-9RT](#) [VI-N61-CM](#) [VI-](#)
[R5022-EXWW](#) [PSC128-7iR](#) [RPS8-350ATX-XE](#) [DAS1004812](#) [PQA30-D24-S24-DH](#) [VI-M5F-CQ](#) [VI-LN2-EW](#) [VI-PJW01-CZY](#)