

4:1 Intermediate Bus Converter Module: Up to 650W Output

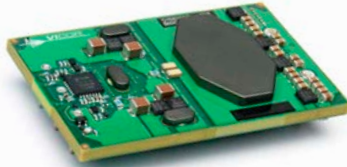

Size:
2.30 x 1.45 x 0.42in
58.4 x 36.8 x 10.6mm



Features & Benefits

- Input: 36 – 60V_{DC} (38 – 55V_{DC} for IB048x)
- Output: 12.0V_{DC} at 48V_{IN}
- Output current up to 53A
- Output power: up to 650W *
- 2250V_{DC} isolation (1500V_{DC} isolation for IB048x)
- 97.9% peak efficiency
- Low profile: 0.42" height above board
- Industry standard 1/4 Brick pinout
- Sine Amplitude Converter™ (SACT™)
- Low noise 1MHz ZVS/ZCS

* For lower power applications see 300W model IB0Q120T32xx-xx

Typical Applications

- Enterprise networks
- Optical access networks
- Storage networks
- Automated test equipment

Product Description

The Intermediate Bus Converter (IBC) Module is a very efficient, low profile, isolated, fixed ratio converter for power system applications in enterprise and optical access networks.

Rated at up to 477W from 36V_{IN} and up to 650W from 50 to 60V_{IN}, the IBC conforms to an industry standard quarter-brick footprint while supplying power greatly exceeding competitive quarter-bricks. Its leading efficiency enables full load operation at 55°C with only 200LFM airflow. Its small cross section facilitates unimpeded airflow — above and below its thin body — to minimize the temperature rise of downstream components. A baseplate option is available for alternative cooling schemes.

Part Ordering Information

Product Function		Input Voltage			Package	Output Voltage (Nom.) x 10			Temperature Grade	Output Current		Enable Logic	Pin Length	Options		
I	B	0	x	x	Q	1	2	0	T	5	3	x	x	-	x	x

IB = Intermediate Bus Converter

Q = Quarter Brick Format

T = -40°C ≤ T_{OPERATING} ≤ +100°C
-40°C ≤ T_{STORAGE} ≤ +125°C

N = Negative
P = Positive

00 = Open frame
BP = Baseplate

048 = 38 – 55V_{DC}
050 = 36 – 60V_{DC}
054 = 36 – 60V_{DC} *
* Operating transient to 75V_{DC}

120 = (V_{OUT} nominal @ V_{IN} = 48V_{DC} x 10
(4:1 transfer ratio)

53 = Max Rated Output Current

1 = 0.145"
2 = 0.210"
3 = 0.180"

Absolute Maximum Ratings

The absolute maximum ratings below are stress ratings only. Operation at or beyond these maximum ratings can cause permanent damage to the device.

Parameter	Comments	Min	Max	Unit
Input voltage (+IN to -IN)	See Input Range Specific Characteristics for details	-0.5	75	V _{DC}
Input voltage slew rate			5	V / μ s
EN to -IN		-0.5	20	V _{DC}
Output voltage (+OUT to -OUT)	See OVP setpoint max	-0.5	(see note)	V _{DC}
Output current	P _{OUT} \leq 650W		53	A
Dielectric withstand				
Input to output	1min	2250 1500 for IB048x		V _{DC}
Output to baseplate	1min	707		
Temperature				
Operating junction	Hottest semiconductor	-40	125	°C
Operating baseplate		-40	100	
Storage		-55	125	

Electrical Specifications

Specifications valid at 48V_{IN}, 100% rated load and 25°C ambient, unless otherwise indicated.

Attribute	Symbol	Conditions / Notes	Min	Typ	Max	Unit
Input Range Specific Characteristics						
Part Number IB048Q120T53xx-xx						
Operating input voltage			38	48	55	V _{DC}
Non-operating input surge withstand		< 100ms			75	V _{DC}
Operating input dV / dt			0.003		5	V / μ s
Undervoltage protection						
Turn-on			33		38	V _{DC}
Turn-off			31		36	V _{DC}
Turn-on / turn-off hysteresis			2			V _{DC}
Time constant					7	μ s
Undervoltage blanking time		UV blanking time is enabled after start up	50	100	200	μ s
Overvoltage protection						
Turn-off			60		64	V _{DC}
Turn-on			55		64	V _{DC}
Time constant					4	μ s
DC output voltage band		No load, over V _{IN} range	9.5	12.0	13.8	V _{DC}
Output OVP set point		Module will shut down	15.0		16.0	V _{DC}
Dielectric withstand		Input to output and input to baseplate; 1min	1500			V _{DC}
		Output to baseplate	707			
Insulation resistance		Input to output		30		M Ω

Electrical Specifications (Cont.)

Specifications valid at 48V_{IN}, 100% rated load and 25°C ambient, unless otherwise indicated.

Attribute	Symbol	Conditions / Notes	Min	Typ	Max	Unit
Input Range Specific Characteristics						
Part Number IB050Q120T53xx-xx						
Operating input voltage			36	48	60	V _{DC}
Non-operating input surge withstand		< 100ms			75	V _{DC}
Operating input dV / dt			0.003		5	V / μs
Undervoltage protection						
Turn-on			31		36	V _{DC}
Turn-off			29		34	V _{DC}
Turn-on / turn-off hysteresis			2			V _{DC}
Time constant					7	μs
Undervoltage blanking time		UV blanking time is enabled after start up	50	100	200	μs
Overvoltage protection						
Turn-off			65		69	V _{DC}
Turn-on			60		69	V _{DC}
Time constant					4	μs
DC output voltage band		No load, over V _{IN} range	9	12	15	V _{DC}
Output OVP set point		Module will shut down	16.2		17.2	V _{DC}
Dielectric withstand		Input to output and input to baseplate; 1min	2250			V _{DC}
		Output to baseplate	707			
Insulation resistance		Input to output		30		MΩ

Electrical Specifications (Cont.)

Specifications valid at 48V_{IN}, 100% rated load and 25°C ambient, unless otherwise indicated.

Attribute	Symbol	Conditions / Notes	Min	Typ	Max	Unit
Input Range Specific Characteristics						
Part Number IB054Q120T53xx-xx						
Operating input voltage			36	48	60	V _{DC}
Non-operating input surge withstand		< 100ms			75	V _{DC}
Operating input dV / dt			0.003		5	V / μs
Undervoltage protection						
Turn-on			31		36	V _{DC}
Turn-off			29		34	V _{DC}
Turn-on / turn-off hysteresis			2			V _{DC}
Time constant					7	μs
Undervoltage blanking time		UV blanking time is enabled after start up	50	100	200	μs
Overvoltage protection						
Turn-off			76		79.5	V _{DC}
Turn-on			75		78	V _{DC}
Time constant					4	μs
DC output voltage band		No load, over V _{IN} range	9	12	15	V _{DC}
Output OVP set point		Module will shut down	19		19.8	V _{DC}
Dielectric withstand		Input to output and input to baseplate; 1min	2250			V _{DC}
		Output to baseplate	707			
Insulation resistance		Input to output		30		MΩ

Electrical Specifications (Cont.)

Specifications valid at 48V_{IN}, 100% rated load and 25°C ambient, unless otherwise indicated.

Attribute	Symbol	Conditions / Notes	Min	Typ	Max	Unit
Common Input Specifications						
Turn ON delay						
Start-up inhibit		V _{IN} reaching turn-on voltage to enable function operational, see Figure 7	20	25	30	ms
Turn-on delay		Enable to 10% V _{OUT} ; pre-applied V _{IN} , 0 load capacitance, see Figure 8			50	μs
Output voltage rise time		From 10% to 90% V _{OUT} , 10% load, 0 load capacitance, see Figure 9			50	μs
Restart turn-on delay		See page 15 for restart after EN pin disable			250	ms
No load power dissipation						
Enabled				4.0	5.5	W
Disabled				0.15	0.20	W
Input current		Low line, full load			13.5	A
Inrush current overshoot		Using test circuit in Figure 23, 15% load, high line		13	18.9	A
Input reflected ripple current		At max power; Using test circuit in Figure 24; see Figure 6			650	mArms
Peak short circuit input current					45	A
Repetitive short circuit peak current					25	A
Internal input capacitance				17.6		μF
Internal input inductance				5		nH
Recommended external input capacitance		200nH maximum source inductance	47		470	μF

Electrical Specifications (Cont.)

Specifications valid at 48V_{IN}, 100% rated load and 25°C ambient, unless otherwise indicated.

Attribute	Symbol	Conditions / Notes	Min	Typ	Max	Unit
Common Output Specifications						
Output power *			0		650	W
Output current		$P \leq 650W$			53	A
Output start up load		of I _{OUT} max, maximum output capacitance			15	%
Effective output resistance				3.9		mΩ
Line regulation (K factor)		$V_{OUT} = K \cdot V_{IN}$ @ no load	0.245	0.250	0.252	
Current share accuracy		Full power operation; See Parallel Operation on page 16; up to 3 units			10	%
Efficiency						
50% load		See Figure 1	97.5	97.8		%
Full load		See Figure 1	97.0	97.3		%
Internal output inductance				1.6		nH
Internal output capacitance				75		μF
Load capacitance			0		3000	μF
Output voltage ripple		20MHz bandwidth (Figure 17), using test circuit in Figure 25		60	150	mVp-p
Output overload protection threshold		Of I _{OUT} max, will not shut down when started into max C _{OUT} and 15% load. Auto restart with duty cycle < 10%	105		150	%
Overcurrent protection time constant					1.2	ms
Short circuit current response time					1.5	μs
Switching frequency				1.0		MHz
Dynamic response – load		Load change: ±25% of I _{OUT} max, Slew rate (dI/dt) = 1A/μs See Figures 12–15				
V _{OUT} overshoot / undershoot					100	mV
V _{OUT} response time				1		μs
Dynamic response – line		Line step of 5V in 1μs, within V _{IN} operating range. (C _{IN} = 500μF, C _O = 350μF) (Figure 16 illustrates similar converter response when subjected to a more severe line transient.)				
V _{OUT} overshoot					1.25	V
Pre-bias voltage		Unit will start up into a pre-bias voltage on the output	0		15	V _{DC}

* Does not exceed IPC-9592 derating guidelines. At 70°C ambient, full power operation may exceed IPC-9592 guidelines, but does not exceed component ratings, does not activate OTP and does not compromise reliability.

Electrical Specifications (Cont.)

Specifications valid at 48V_{IN}, 100% rated load and 25°C ambient, unless otherwise indicated.

Attribute	Symbol	Conditions / Notes	Min	Typ	Max	Unit
Control & Interface Specifications						
Enable (negative logic)		Referenced to -IN				
Module enable threshold			0.8			V _{DC}
Module enable current		V _{EN} = 0.8V		130	200	μA
Module disable threshold					2.4	V _{DC}
Module disable current		V _{EN} = 2.4V			10	μA
Disable hysteresis				500		mV
Enable pin open circuit voltage			2.0	2.5	3.0	V _{DC}
EN to -IN resistance		Open circuit		35		kΩ
Enable (positive logic)		Referenced to -IN				
Module enable threshold			2.0	2.5	3.0	V _{DC}
Module disable threshold					1.45	V _{DC}
EN source current (operating)		V _{EN} = 5V			2	mA
EN voltage (operating)			4.7	5	5.3	V _{DC}

General Characteristics						
<ul style="list-style-type: none"> Conditions: T_{CASE} = 25°C, 75% rated load and specified input voltage range unless otherwise specified. 						
Attribute	Symbol	Conditions / Notes	Min	Typ	Max	Unit
MTBF		Calculated per Telcordia SR-332, 40°C	1.0			Mhrs
Service life		Calculated at 30°C	7			Years
Overtemperature shut down		T _J ; Converter will reset when overtemperature condition is removed	125	130	135	°C
Mechanical						
Weight		Open frame (without baseplate)		1.38 / 39.1		oz / g
		Baseplate version		2.25 / 63.9		oz / g
Length				2.30 / 58.4		in / mm
Width				1.45 / 36.8		in / mm
Height above customer board		Open frame version		0.42 / 10.6		in / mm
		With baseplate		0.45 / 11.4		in / mm
Pin solderability		Storage life for normal solderability			1	Years
Moisture sensitivity level	MSL	Not applicable, for wave soldering only	N/A			
Clearance to customer board		From lowest component on IBC		0.12 / 3.0		in / mm
Altitude, operating		Derate operating temp 1°C per 1000 feet above sea level	-500		10000	Feet
Relative humidity, operating		Non condensing	10		90	%
RoHS compliance		Compatible with RoHS directive 2002/95/EC				
Agency approvals		UL/CSA 60950-1				cURus
		UL/CSA 60950-1, EN60950-1				cTUVus
		Low voltage directive (2006/95/EC)				CE

Electrical Specifications (Cont.)

Specifications valid at 48V_{IN}, 100% rated load and 25°C ambient, unless otherwise indicated.

Environmental Qualification		
• IPC-9592A, based on Class II Category 2 the following detail is applicable.		
Test Description	Test Detail	Min. Quantity Tested
5.2.3 HALT (Highly Accelerated Life Testing)	Low temp	3
	High temp	3
	Rapid thermal cycling	3
	6 DOF random vibration test	3
	Input voltage test	3
	Output load test	3
	Combined stresses test	3
5.2.4 THB (Temperature Humidity Bias)	(72hr presoak required) 1000hrs – continuous bias	30
5.2.5 HTOB (High Temperature Operating Bias)	Power cycle – On 42 minutes Off 1 minute, On 1 minute, Off 1 minute, On 1 minute, Off 1 minute, On 1 minute, Off 1 minute, On 1 minute, Off 10 minutes. Alternating between maximum and minimum operating voltage every hour.	30
5.2.6 TC (Temperature Cycling)	700 cycles, 30 minute dwell at each extreme – 20C minimum ramp rate	30
5.2.7 PTC (Power & Temperature Cycling)	Reference IPC-9592A	3
5.2.8 – 5.2.13 Shock and Vibration	Random Vibration – Operating IEC 60068-2-64 (normal operation vibration)	3
	Random Vibration Non-operating (transportation) IEC 60068-2-64	3
	Shock Operating – normal operation shock IEC 60068-2-27	3
	Free fall – IEC 60068-2-32	3
	Drop Test 1 full shipping container (box)	1
5.2.14 Other Environmental Tests	5.2.14.1 Corrosion Resistance – Not required	N / A
	5.2.14.2 Dust Resistance – Unpotted class II GR-1274-CORE	3
	5.2.14.3 SMT Attachment Reliability IPC-9701 – J-STD-002	N / A
	5.2.14.4 Through Hole solderability – J-STD-002	5
ESD Classification Testing	HBM testing - JESD22-A114	3
Total Quantity (estimated)		138

Application Characteristics: Waveforms

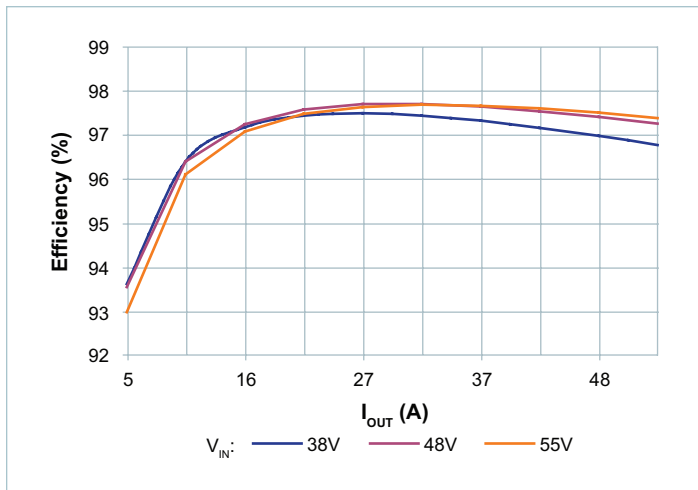

Figure 1 — Efficiency vs. output current, 25°C ambient

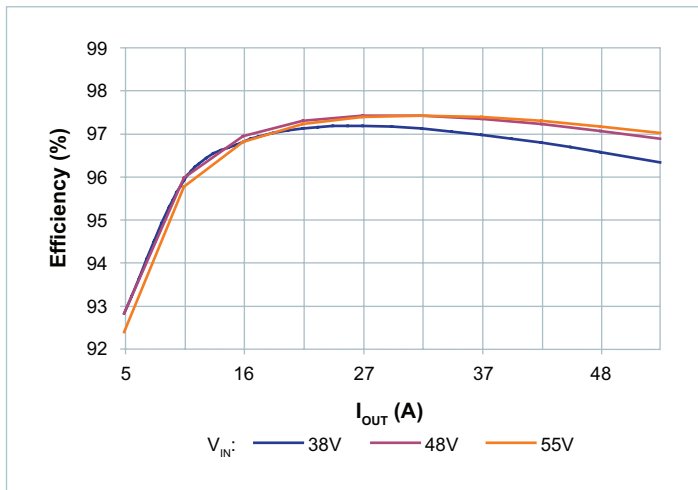

Figure 2 — Efficiency vs. output current, 55°C ambient

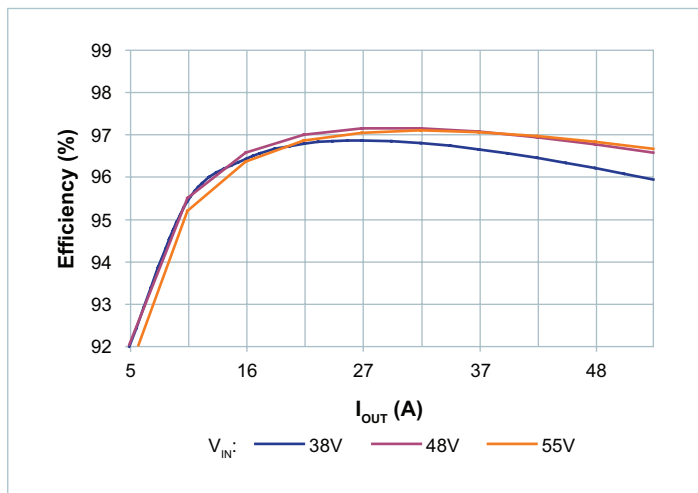

Figure 3 — Efficiency vs. output current, 70°C ambient

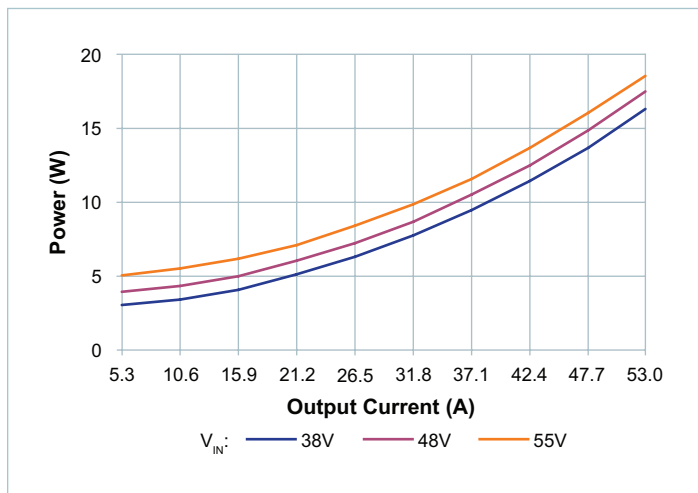

Figure 4 — Power dissipation vs. output current at V_{IN} , 25°C ambient

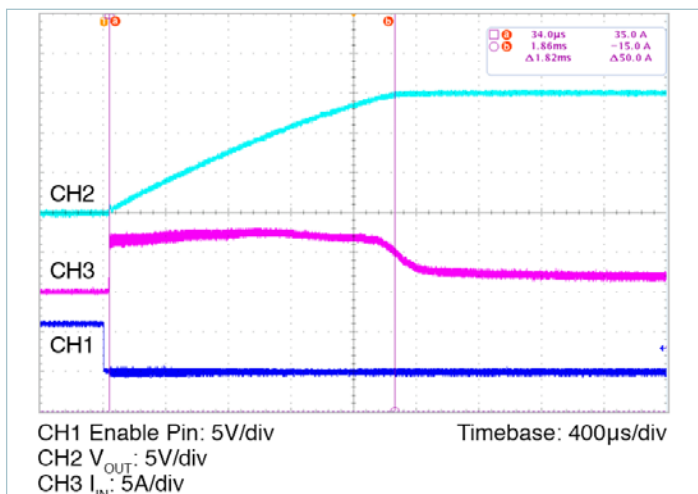

Figure 5 — Inrush current at high line 15% load; 5A/div, max load capacitance

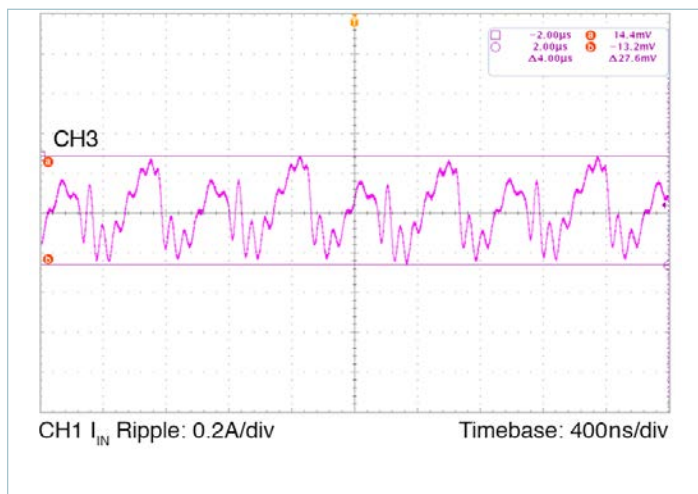

Figure 6 — Input reflected ripple current at nominal line, full load
See Figure 24 for setup

Application Characteristics: Waveforms (Cont.)

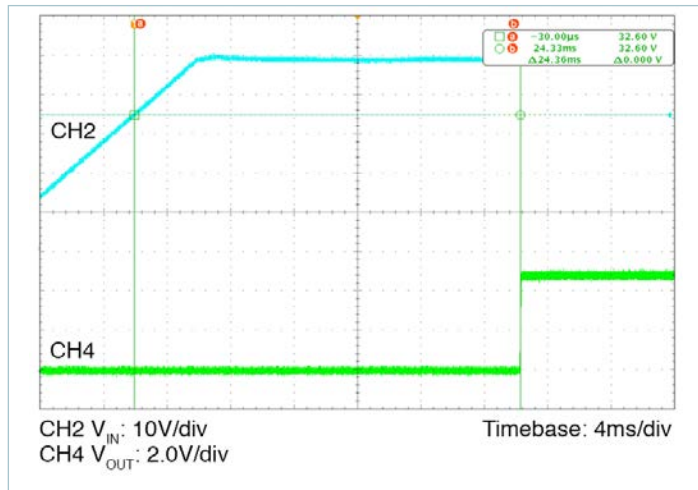

Figure 7 — Turn on delay time; V_{IN} turn on delay at nominal line, 15% load

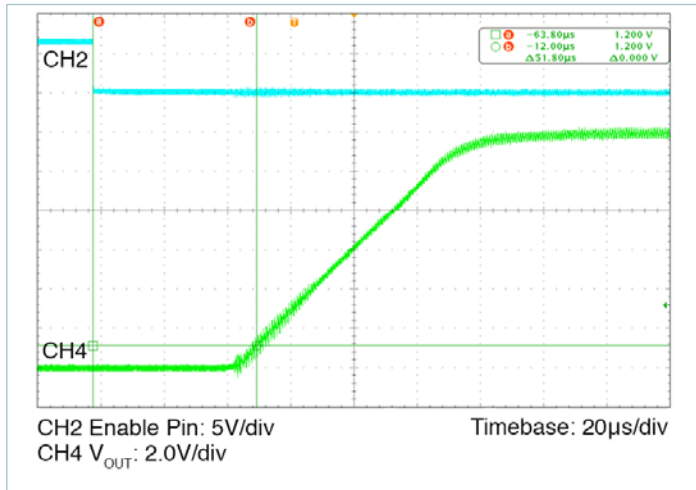

Figure 8 — Turn on delay time; enable at nominal line, 15% load, 0 capacitance.

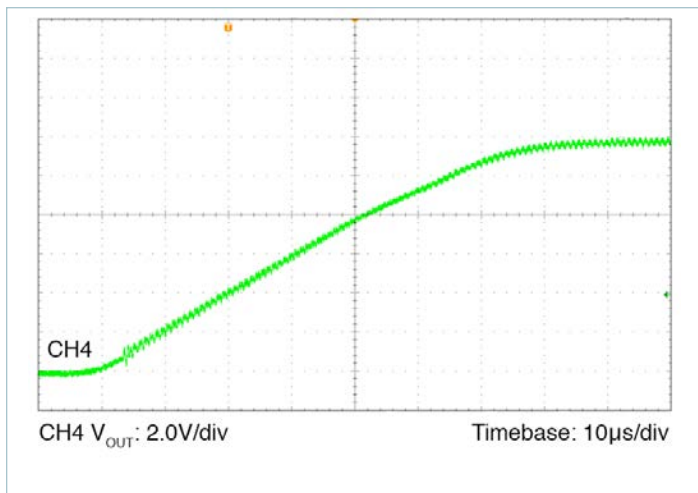

Figure 9 — Output voltage rise time at nominal line, 10% load, 0 capacitance

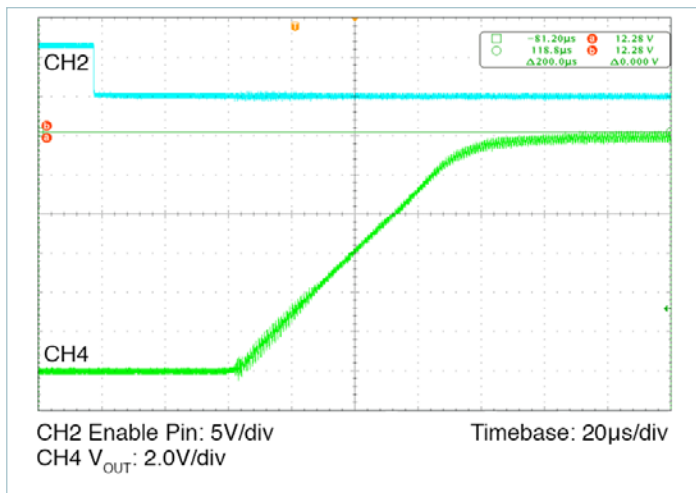

Figure 10 — Overshoot at turn on at nominal line, 15% load, 0 capacitance

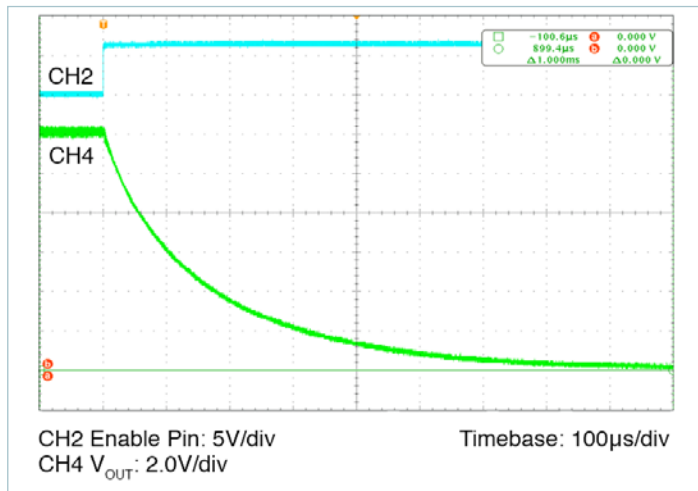

Figure 11 — Undershoot at turn off at nominal line; 15% load, 0 load capacitance

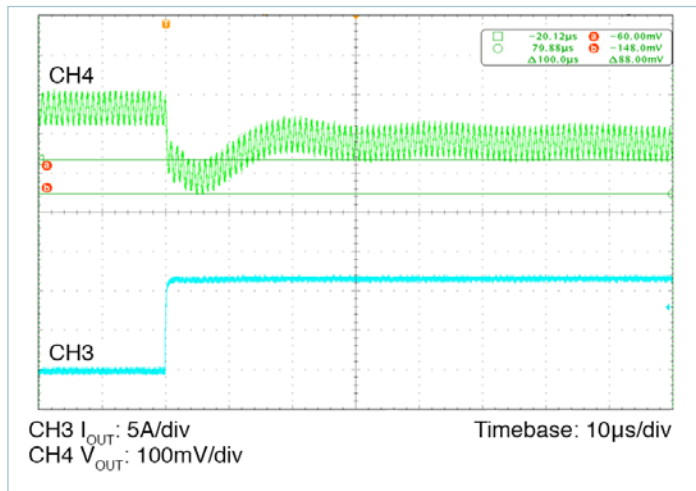

Figure 12 — Load transient response; nominal line, load step 75–100%

Application Characteristics: Waveforms (Cont.)

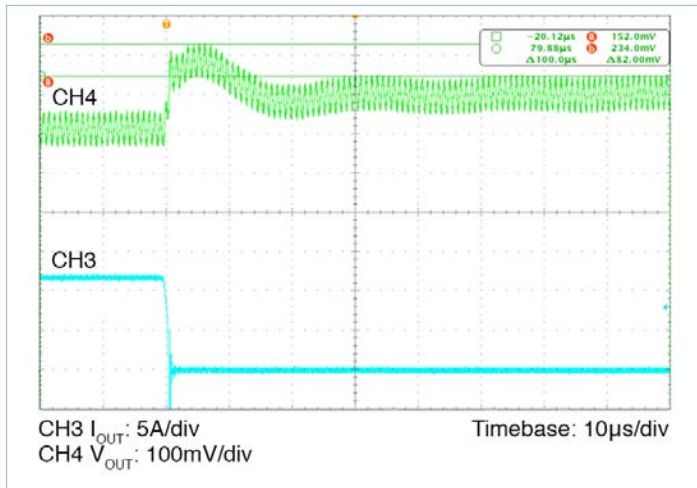

Figure 13 — Load transient response; full load to 75%; nominal line

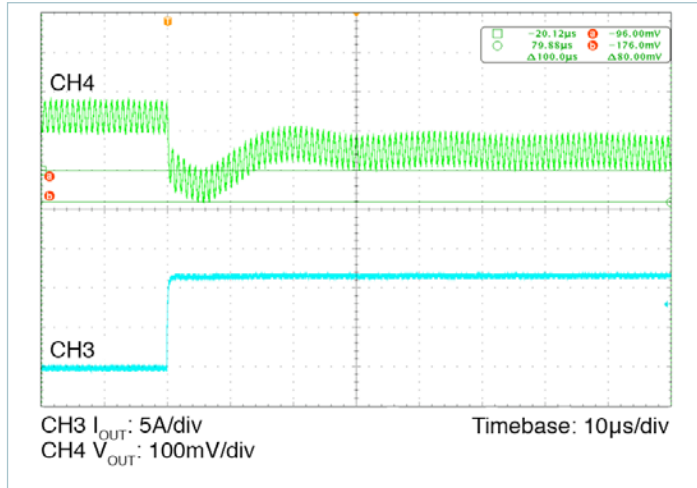

Figure 14 — Load transient response, nominal line
Load step 0-25%

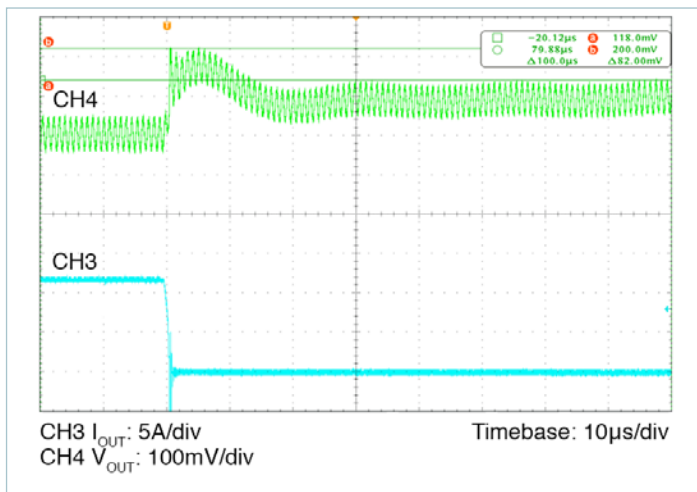

Figure 15 — Load transient response; nominal line
Load step 25-0%

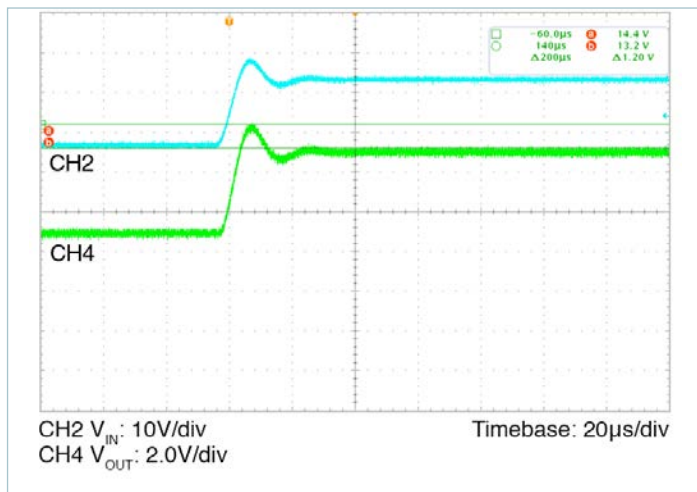

Figure 16 — Input transient response;
 V_{IN} step low line to high line at full load

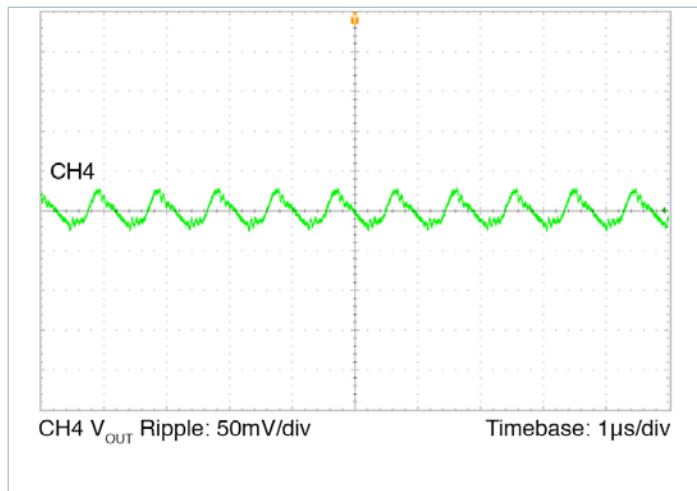

Figure 17 — Output ripple; nominal line, full load

Application Characteristics: Waveforms (Cont.)

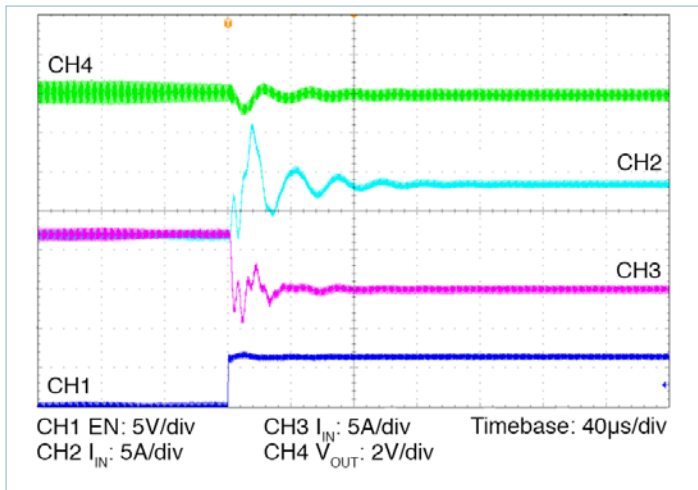

Figure 18 — Two modules parallel array test. V_{OUT} and I_{IN} change when one module is disabled. Nominal V_{IN} , $I_{OUT} = 53A$

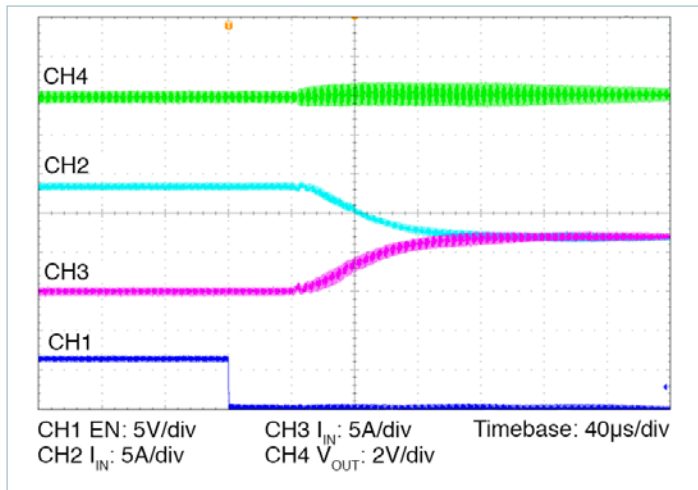

Figure 19 — Two modules parallel array test. V_{OUT} and I_{IN} change when one module is enabled. Nominal V_{IN} , $I_{OUT} = 53A$

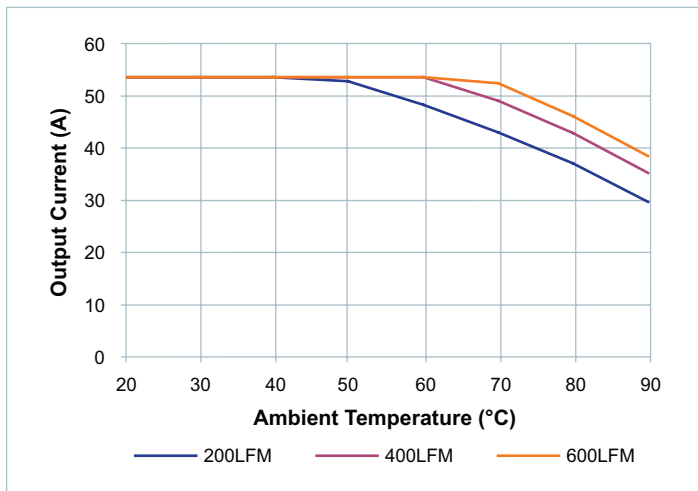

Figure 20 — Maximum output current derating vs. ambient air temperature. Transverse airflow. Board and junction temperatures within IPC-9592 derating guidelines

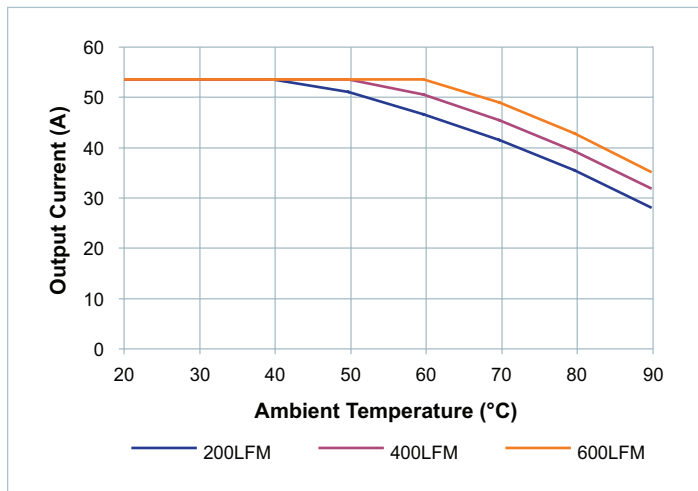

Figure 21 — Maximum output current derating vs. ambient air temperature. Longitudinal airflow. Board and junction temperatures within IPC-9592 derating guidelines

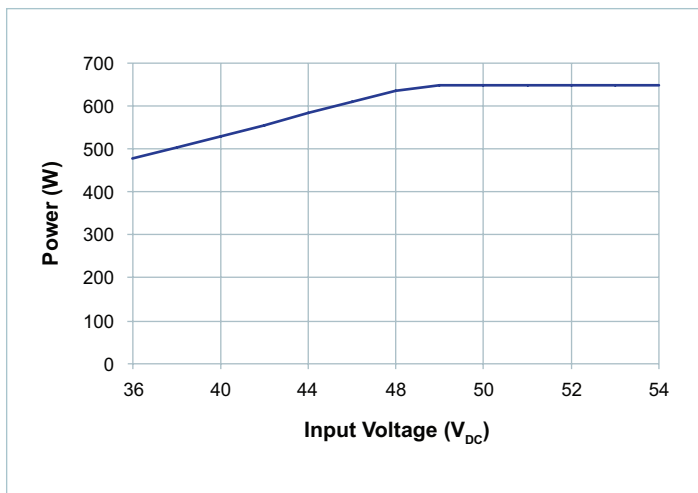

Figure 22 — Maximum output power vs. input voltage

Application Characteristics: Waveforms (Cont.)

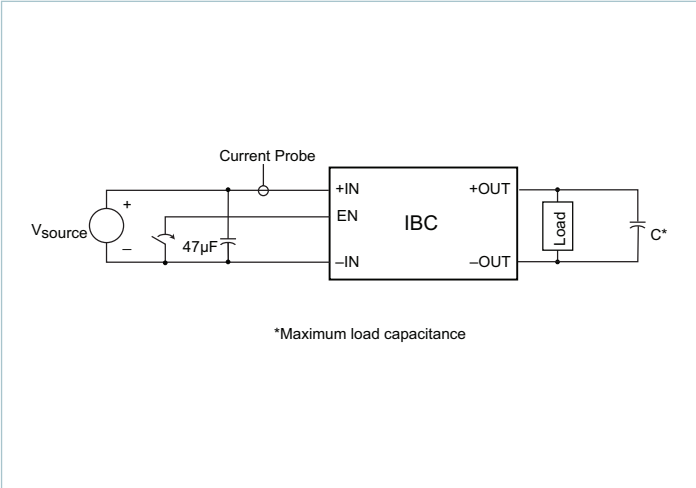

Figure 23 — Test circuit; inrush current overshoot

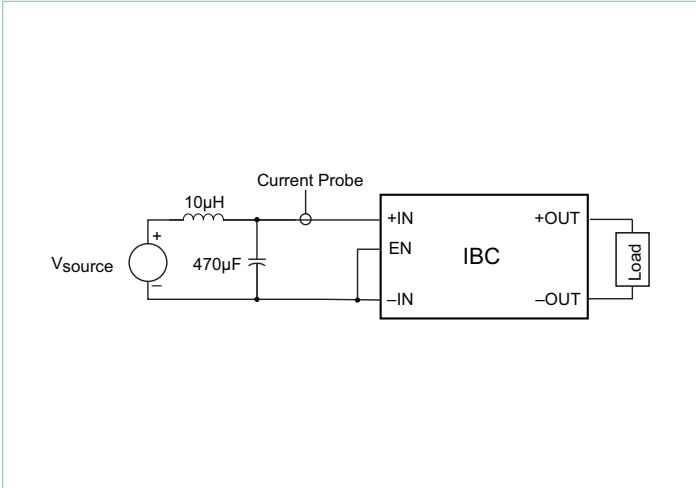

Figure 24 — Test circuit; input reflected ripple current

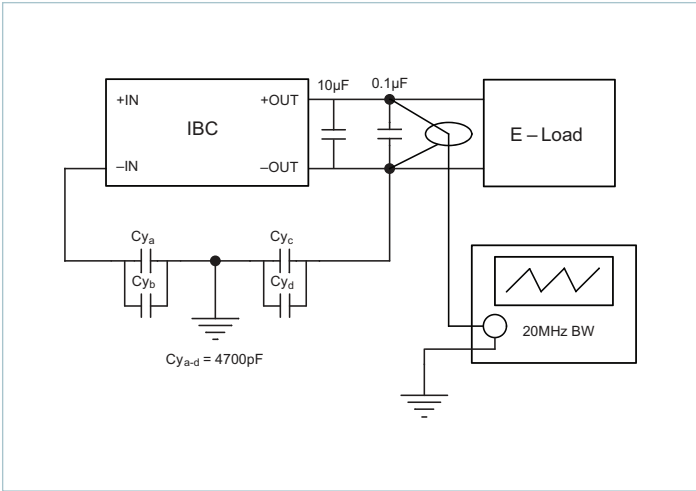

Figure 25 — Test circuit; output voltage ripple

Application Characteristics: Thermal Data

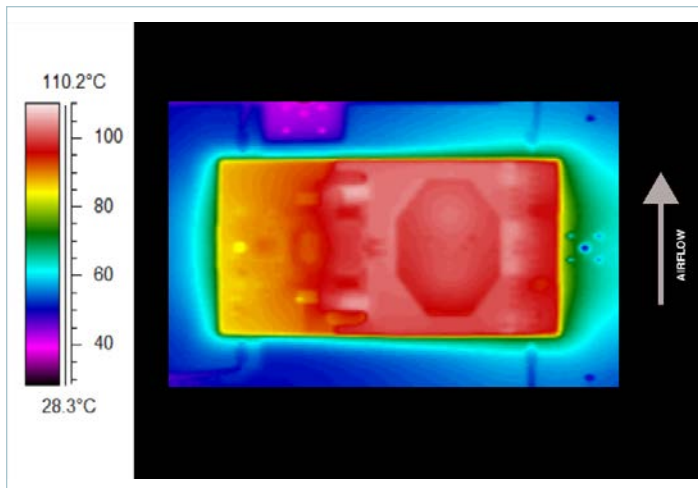

Figure 26 — Thermal plot, 200LFM, 25°C, 48V_{IN}, 600W output power

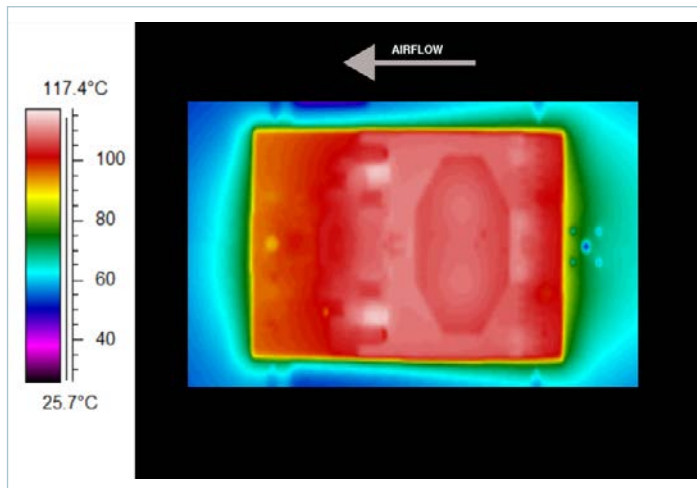

Figure 27 — Thermal plot, 200LFM, 25°C, 48V_{IN}, 600W output power

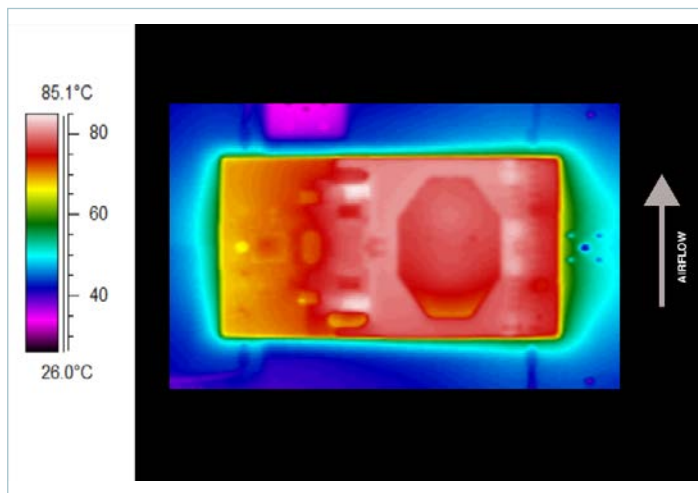

Figure 28 — Thermal plot, 400LFM, 25°C, 48V_{IN}, 600W output power

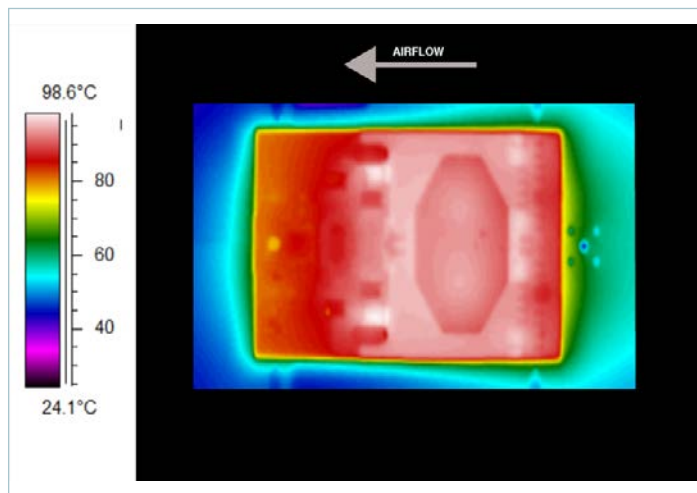

Figure 29 — Thermal plot, 400LFM, 25°C, 48V_{IN}, 600W output power

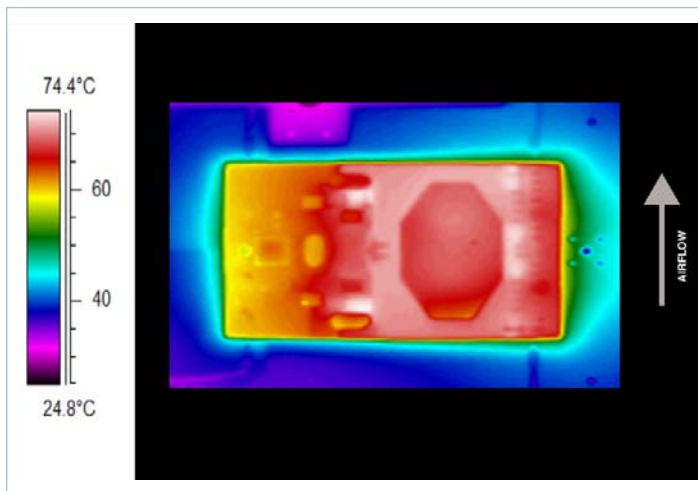

Figure 30 — Thermal plot, 600LFM, 25°C, 48V_{IN}, 600W output power

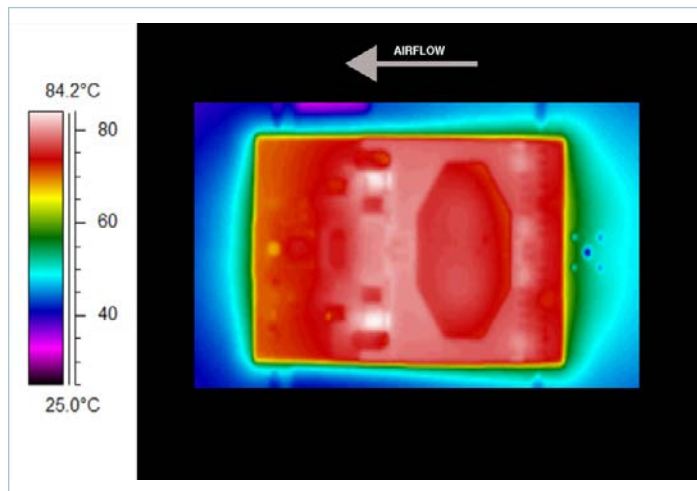

Figure 31 — Thermal plot, 600LFM, 25°C, 48V_{IN}, 600W output power

Pin / Control Functions

+IN / -IN — DC Voltage Input Pins

The IBC input voltage range should not be exceeded. An internal undervoltage/overvoltage lockout function prevents operation outside of the normal operating input range. The IBC turns on within an input voltage window bounded by the “Input undervoltage turn-on” and “Input overvoltage turn-off” levels, as specified. The IBC may be protected against accidental application of a reverse input voltage by the addition of a rectifier in series with the positive input, or a reverse rectifier in shunt with the positive input located on the load side of the input fuse.

The connection of the IBC to its power source should be implemented with minimal distribution inductance. If the interconnect inductance exceeds 100nH, the input should be bypassed with a RC damper to retain low source impedance and stable operation. With an interconnect inductance of 200nH, the RC damper may be 47 μ F in series with 0.3 Ω . A single electrolytic or equivalent low-Q capacitor may be used in place of the series RC bypass.

EN — Enable/Disable

Negative logic option

If the EN port is left floating, the IBC output is disabled. Once this port is pulled lower than 0.8V_{DC} with respect to -IN, the output is enabled. The EN port can be driven by a relay, optocoupler, or open collector transistor. Refer to Figure 8 for the typical enable / disable characteristics. This port should not be toggled at a rate higher than 1Hz. The EN port should also not be driven by or pulled up to an external voltage source.

Positive logic option

If the EN port is left floating, the IBC output is enabled. Once this port is pulled lower than 1.4V_{DC} with respect to -IN, the output is disabled. This action can be realized by employing a relay, optocoupler, or open collector transistor. This port should not be toggled at a rate higher than 1Hz.

The EN port should also not be driven by or pulled up to an external voltage source. The EN port can source up to 2mA at 5V_{DC}. The EN port should never be used to sink current.

If the IBC is disabled using the EN pin, the module will attempt to restart approximately every 250ms. Once the module has been disabled for at least 250ms, the turn on delay after the EN pin is enabled will be as shown in Figure 8.

+OUT / -OUT — DC Voltage Output Pins

Total load capacitance at the output of the IBC should not exceed the specified maximum. Owing to the wide bandwidth and low output impedance of the IBC, low frequency bypass capacitance and significant energy storage may be more densely and efficiently provided by adding capacitance at the input of the IBC.

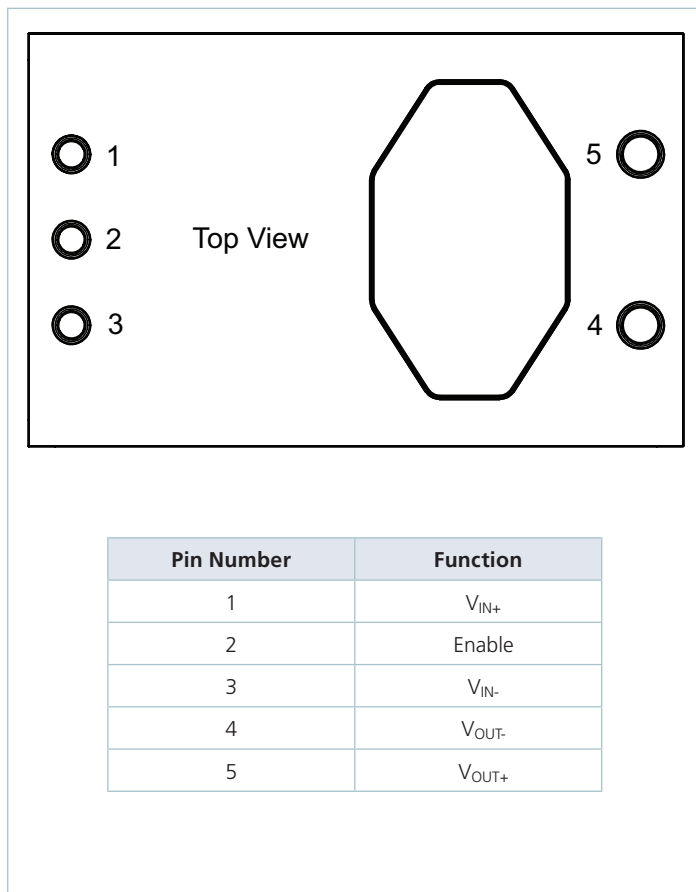

Figure 32 — IBC Pin Designations

Applications Note

Parallel Operation

The IBC will inherently current share when operated in an array. Arrays may be used for higher power or redundancy in an application. Current sharing accuracy is maximized when the source and load impedance presented to each IBC within an array are equal. The recommended method to achieve matched impedances is to dedicate common copper planes within the PCB to deliver and return the current to the array, rather than rely upon traces of varying lengths. In typical applications the current being delivered to the load is larger than that sourced from the input, allowing narrower traces to be utilized on the input side if necessary. The use of dedicated power planes is, however, preferable.

One or more IBCs in an array may be disabled without adversely affecting operation or reliability as long as the load does not exceed the rated power of the enabled IBCs.

The IBC power train and control architecture allow bi-directional power transfer, including reverse power processing from the IBC output to its input. The IBC's ability to process power in reverse improves the IBC transient response to an output load dump.

Thermal Considerations

The temperature distribution of the VI Brick® can vary significantly with its input / output operating conditions, thermal management and environmental conditions. Although the PCB is UL rated to 130°C, it is recommended that PCB temperatures be maintained at or below 125°C. For maximum long term reliability, lower PCB temperatures are recommended for continuous operation, however, short periods of operation at 125°C will not negatively impact performance or reliability.

WARNING: Thermal and voltage hazards. The IBC can operate with surface temperatures and operating voltages that may be hazardous to personnel. Ensure that adequate protection is in place to avoid inadvertent contact.

Input Impedance Recommendations

To take full advantage of the IBC capabilities, the impedance presented to its input terminals must be low from DC to approximately 5MHz. The source should exhibit low inductance and should have a critically damped response. If the interconnect inductance is excessive, the IBC input pins should be bypassed with an RC damper (e.g., 47µF in series with 0.3Ω) to retain low source impedance and proper operation. Given the wide bandwidth of the IBC, the source response is generally the limiting factor in the overall system response.

Anomalies in the response of the source will appear at the output of the IBC multiplied by its K factor. The DC resistance of the source should be kept as low as possible to minimize voltage deviations. This is especially important if the IBC is operated near low or high line as the overvoltage/undervoltage detection circuitry could be activated.

Input Fuse Recommendations

The IBC is not internally fused in order to provide flexibility in configuring power systems. However, input line fusing of VI Bricks must always be incorporated within the power system. A fast acting fuse should be placed in series with the +IN port. See safety agency approvals.

Application Notes

For IBC and VI Brick application notes on soldering, thermal management, board layout, and system design visit www.vicorpower.com.

Mechanical Drawings

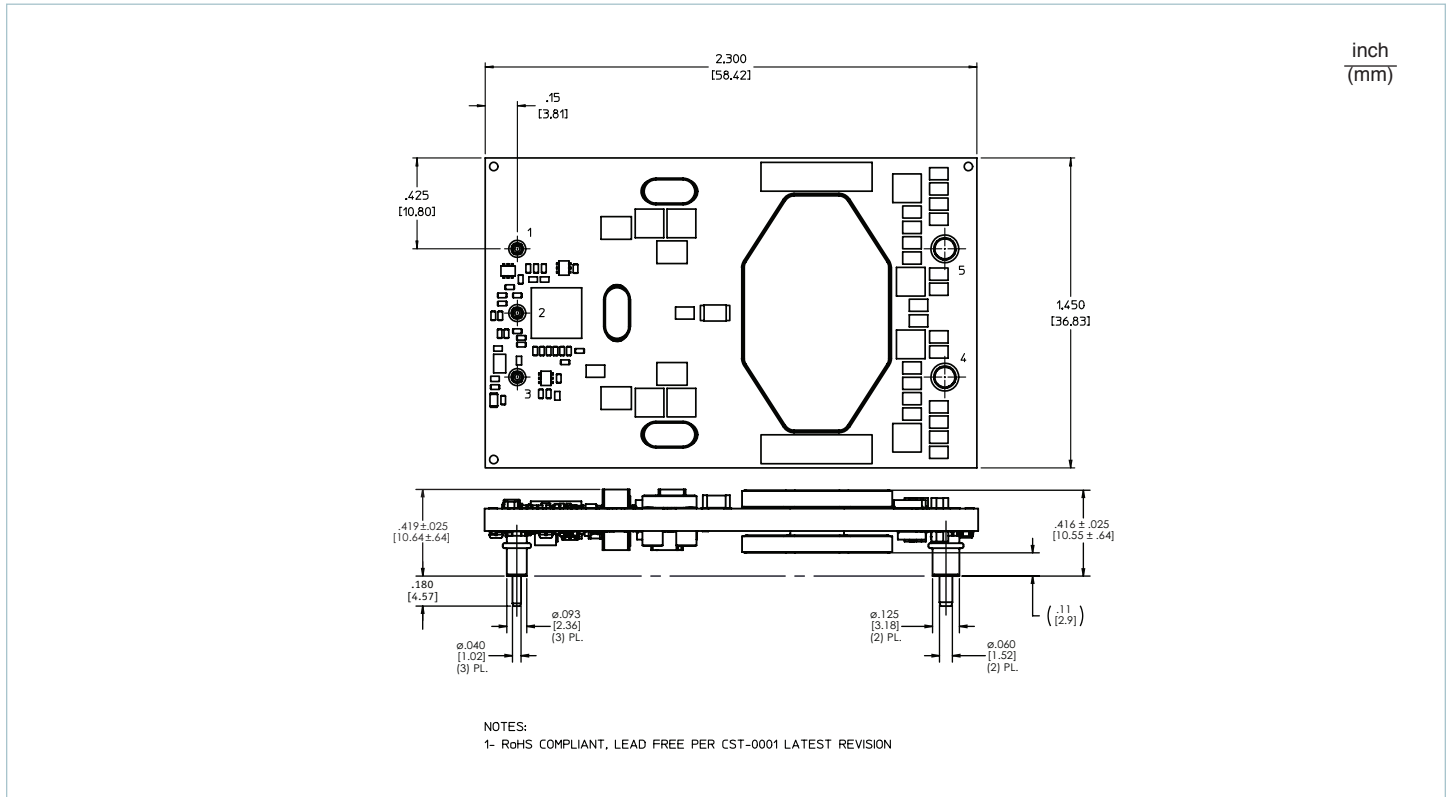

Figure 33 — IBC outline drawing

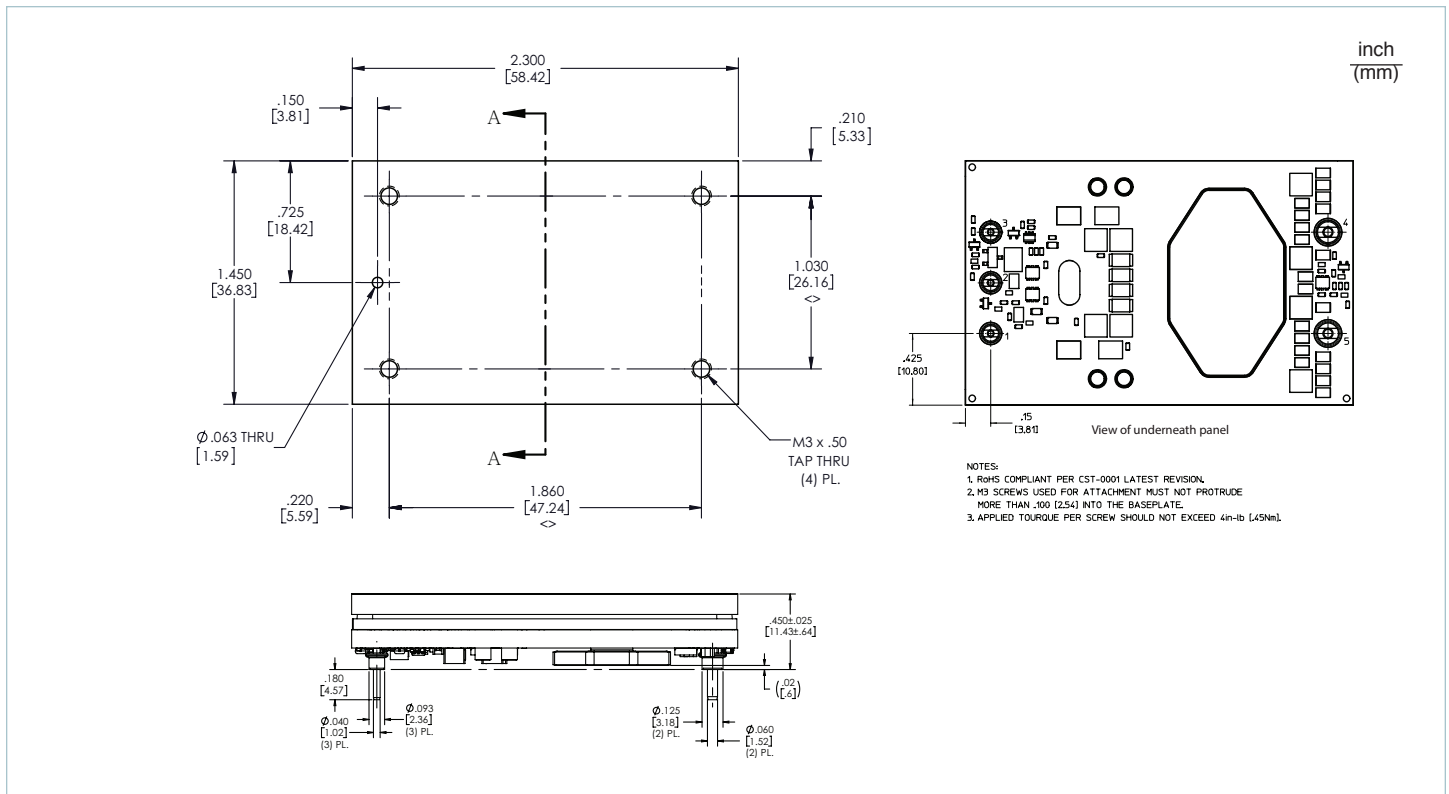

Figure 34 — IBC outline drawing – baseplate option

Mechanical Drawings (Cont.)

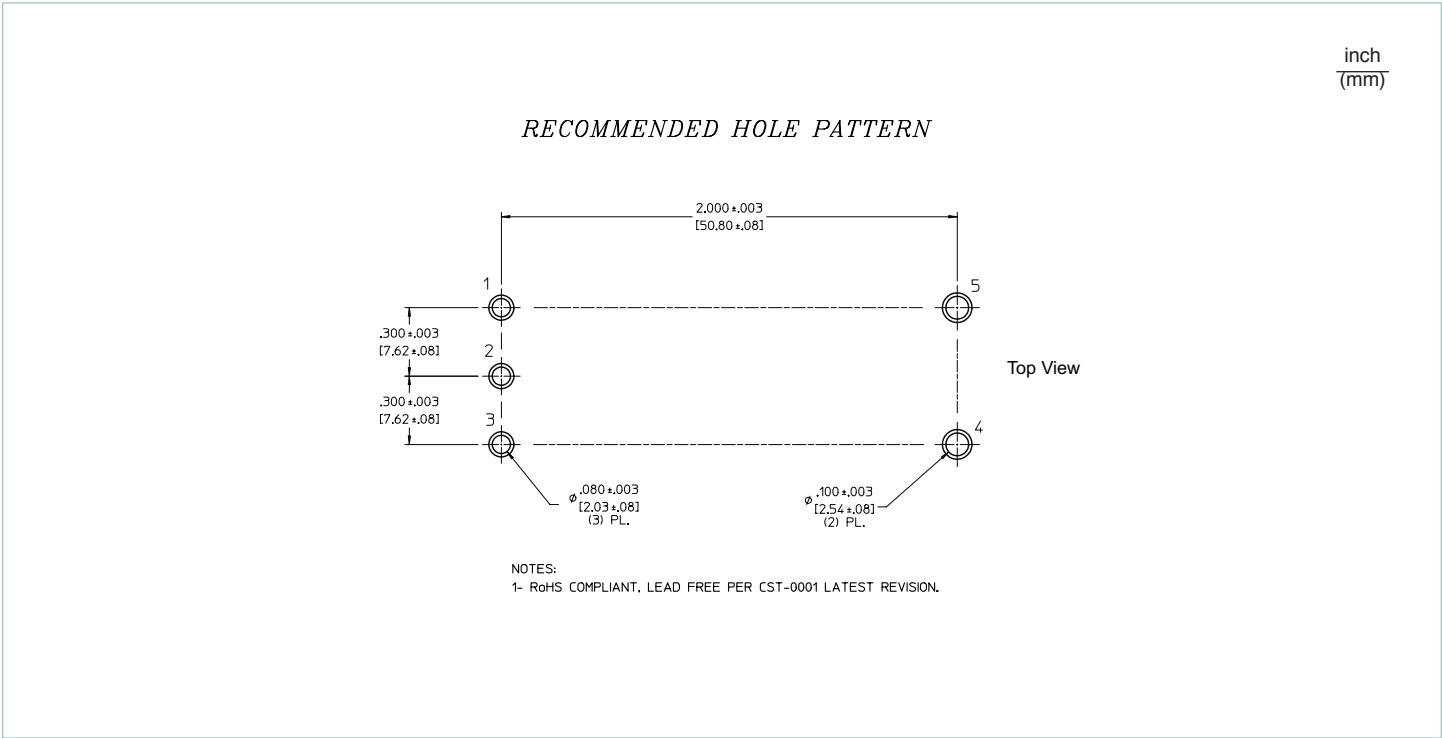

Figure 35 — IBC PCB recommended hole pattern

Vicor's comprehensive line of power solutions includes high density AC-DC and DC-DC modules and accessory components, fully configurable AC-DC and DC-DC power supplies, and complete custom power systems.

Information furnished by Vicor is believed to be accurate and reliable. However, no responsibility is assumed by Vicor for its use. Vicor makes no representations or warranties with respect to the accuracy or completeness of the contents of this publication. Vicor reserves the right to make changes to any products, specifications, and product descriptions at any time without notice. Information published by Vicor has been checked and is believed to be accurate at the time it was printed; however, Vicor assumes no responsibility for inaccuracies. Testing and other quality controls are used to the extent Vicor deems necessary to support Vicor's product warranty. Except where mandated by government requirements, testing of all parameters of each product is not necessarily performed.

Specifications are subject to change without notice.

Vicor's Standard Terms and Conditions

All sales are subject to Vicor's Standard Terms and Conditions of Sale, which are available on Vicor's webpage or upon request.

Product Warranty

In Vicor's standard terms and conditions of sale, Vicor warrants that its products are free from non-conformity to its Standard Specifications (the "Express Limited Warranty"). This warranty is extended only to the original Buyer for the period expiring two (2) years after the date of shipment and is not transferable.

UNLESS OTHERWISE EXPRESSLY STATED IN A WRITTEN SALES AGREEMENT SIGNED BY A DULY AUTHORIZED VICOR SIGNATORY, VICOR DISCLAIMS ALL REPRESENTATIONS, LIABILITIES, AND WARRANTIES OF ANY KIND (WHETHER ARISING BY IMPLICATION OR BY OPERATION OF LAW) WITH RESPECT TO THE PRODUCTS, INCLUDING, WITHOUT LIMITATION, ANY WARRANTIES OR REPRESENTATIONS AS TO MERCHANTABILITY, FITNESS FOR PARTICULAR PURPOSE, INFRINGEMENT OF ANY PATENT, COPYRIGHT, OR OTHER INTELLECTUAL PROPERTY RIGHT, OR ANY OTHER MATTER.

This warranty does not extend to products subjected to misuse, accident, or improper application, maintenance, or storage. Vicor shall not be liable for collateral or consequential damage. Vicor disclaims any and all liability arising out of the application or use of any product or circuit and assumes no liability for applications assistance or buyer product design. Buyers are responsible for their products and applications using Vicor products and components. Prior to using or distributing any products that include Vicor components, buyers should provide adequate design, testing and operating safeguards.

Vicor will repair or replace defective products in accordance with its own best judgment. For service under this warranty, the buyer must contact Vicor to obtain a Return Material Authorization (RMA) number and shipping instructions. Products returned without prior authorization will be returned to the buyer. The buyer will pay all charges incurred in returning the product to the factory. Vicor will pay all reshipment charges if the product was defective within the terms of this warranty.

Life Support Policy

VICOR'S PRODUCTS ARE NOT AUTHORIZED FOR USE AS CRITICAL COMPONENTS IN LIFE SUPPORT DEVICES OR SYSTEMS WITHOUT THE EXPRESS PRIOR WRITTEN APPROVAL OF THE CHIEF EXECUTIVE OFFICER AND GENERAL COUNSEL OF VICOR CORPORATION. As used herein, life support devices or systems are devices which (a) are intended for surgical implant into the body, or (b) support or sustain life and whose failure to perform when properly used in accordance with instructions for use provided in the labeling can be reasonably expected to result in a significant injury to the user. A critical component is any component in a life support device or system whose failure to perform can be reasonably expected to cause the failure of the life support device or system or to affect its safety or effectiveness. Per Vicor Terms and Conditions of Sale, the user of Vicor products and components in life support applications assumes all risks of such use and indemnifies Vicor against all liability and damages.

Intellectual Property Notice

Vicor and its subsidiaries own Intellectual Property (including issued U.S. and pending patent applications) relating to the products described in this data sheet. No license, whether express, implied, or arising by estoppel or otherwise, to any intellectual property rights is granted by this document. Interested parties should contact Vicor's Intellectual Property Department.

The products described on this data sheet are protected by the following U.S. Patents Numbers:
5,945,130; 6,403,009; 6,710,257; 6,911,848; 6,930,893; 6,934,166; 6,940,013; 6,969,909; 7,038,917; 7,145,786;
7,166,898; 7,187,263; 7,361,844; D496,906; D505,114; D506,438; D509,472; and for use under 6,975,098 and 6,984,965.

Vicor Corporation

25 Frontage Road
Andover, MA, USA 01810
Tel: 800-735-6200
Fax: 978-475-6715

email

Customer Service: custserv@vicorpower.com
Technical Support: apps@vicorpower.com

X-ON Electronics

Largest Supplier of Electrical and Electronic Components

Click to view similar products for [Vicor manufacturer:](#)

Other Similar products are found below :

[MI-LJ20-MA](#) [PFM4914BB6M24D0C08](#) [PI3111-00-EVAL1](#) [PI3301-00-EVAL1](#) [PI3303-20-EVAL1](#) [PI3545-00-EVAL1](#) [PS1-01-48-G](#) [QPO-1-EVAL1](#) [DCM300P120T400A40](#) [BCD380P475T1K2A30](#) [30722](#) [18390](#) [19-130041](#) [PI3106-00-EVAL1](#) [PI3109-00-EVAL1](#) [PI3311-21-EVAL1](#) [BCM48BF240T300A00](#) [BCM6123E60E15A3T00](#) [V150C15C150BL](#) [V24B28C200BL](#) [V24B3V3C100BL](#) [V24B48T200BL](#) [V24C12M100BL](#) [V28C15T100BG](#) [V300B24C250BL3](#) [V300B28T250BL](#) [V300C12C150BL](#) [V300C28M150BL](#) [V375B3V3H150BL](#) [V48A28C500BL](#) [V48C15C75BL](#) [V48C3V3C75BL](#) [VE-J71-CY](#) [VI-202-CX](#) [VI-211-CW](#) [VI-241-EU](#) [VI-243-IW](#) [VI-264-IU](#) [VI-2W0-IV](#) [VI-LU3-IW](#) [VI-LW3-CV](#) [VI-RAM-C1](#) [DCD24AP360T320A50](#) [DCM3414V50M26C2C01](#) [VI-NC13-IP](#) [VI-N53-IM](#) [VI-LUY-CU](#) [VI-J42-CZ](#) [VI-J40-CZ](#) [VI-J1M-EZ](#)