

## 28 Volt input, 7 Amp M-Grade EMI Filter Module

### Product Description

The MQPI-18 attenuates conducted common-mode (CM) and differential-mode (DM) noise for DC-DC converters including the VI Chip MIL PRM to comply with MIL-STD-461F EMI requirements for conducted noise measurements. The filter operates within the full input operating range of a 28 V MIL PRM and supports 7 A loads up to 85°C (T<sub>A</sub>) without de-rating.

### Features

- 50 Vin max. input
- Compatible to most industry standard DC-DC converters including VI Chip MIL PRM
- MIL-STD-461F compliant<sup>[a]</sup> CE101, CE102, CS101, CS106, CS114, CS115, and CS116
- 100 Vdc surge, 100 ms
- 1,500 Vdc hipot hold-off to shield plane
- 7 A rating
- 12.9 x 25.3 x 5.0 mm, lidded SiP (System-in-Package)
- 12.4 x 24.9 x 4.2 mm, open-frame
- -55° to +125°C PCB temperature (see Figure 4)
- Efficiency >99%
- Pb solder construction

### Applications

- Rugged Environment
- Displays
- Wireless Communications

### Assembly Process Compatibility

- Designed for Pb solder SMT assembly
- Compatible with typical aqueous cleaning processes (MQPI-18LP-01, open-frame only)
- Compatible with most conformal coating compounds (MQPI-18LP-01, open-frame only, after reflow)



MQPI-18LP (~1/2 in<sup>2</sup> area)

### Typical Application

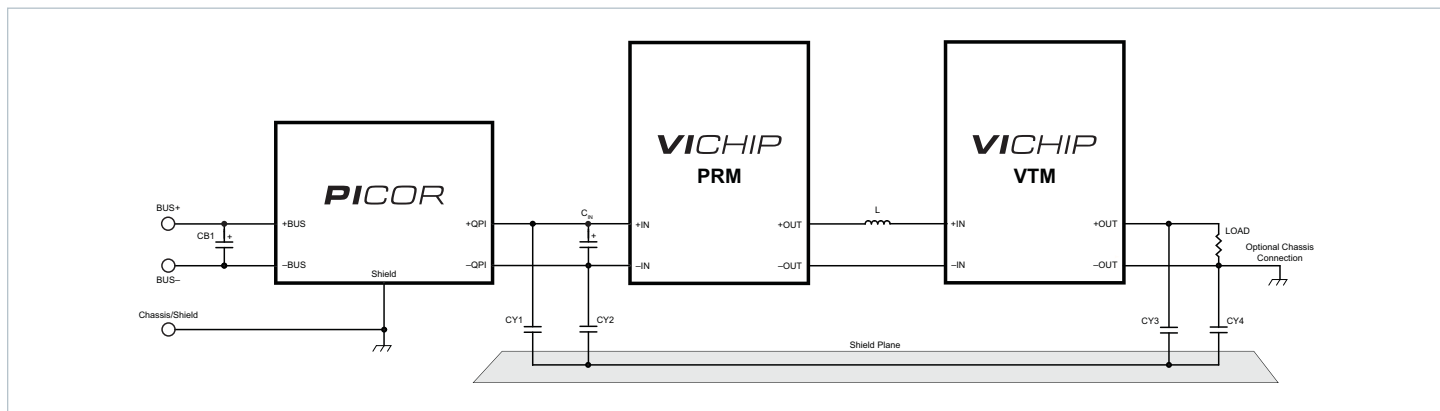

Figure 1 — Typical MQPI-18 application schematic with Vicor's MP028 PRM and MV036 VTM modules. <sup>[b]</sup>

<sup>[a]</sup> When combined with MP028 PRMs and MV036 VTMs.

<sup>[b]</sup> CB1 capacitor, referenced in all schematics, is a 47 uF electrolytic; United Chemi-Con EMVE101ARA470MKE05 or equivalent. CY1 to CY4, referenced in all schematics, are 4.7 nF hi-voltage safety capacitors; Vishay VY1472M63Y5UQ63V0 or equivalent.

Order Information

Part Number	Description
MQPI-18LP	MQPI-18 LGA package
MQPI-18LP-01	MQPI-18 LGA package, open-frame package
<b>Also Available</b>	
MQPI-18-CB1	A MQPI-18LP mounted on a carrier board that can be paired with PRM/VTM and Cool-Power® evaluation boards available from Vicor.

Absolute Maximum Ratings

Exceeding these parameters may result in permanent damage to the product.

Name	Rating
Input voltage, BUS+ to BUS-, continuous	-50 to 50 Vdc
Input voltage, BUS+ to BUS-, 100 ms transient	-100 to 100 Vdc
BUS+/ BUS- to Shield pads, hipot	-750 to 750 Vdc
Input to output current, continuous @ 25°C T <sub>A</sub>	7 Adc
Power dissipation, @ 85°C T <sub>A</sub> , 7 A <sup>[c]</sup>	1.85 W
Operating temperature - T <sub>A</sub>	-55 to 125°C
Thermal resistance <sup>[c]</sup> - R <sub>θJ-A</sub> , using PCB layout in Figure 12	30°C/W
Thermal resistance <sup>[c]</sup> - R <sub>θJ-PCB</sub>	18°C/W
Storage temperature, JEDEC Standard J-STD-033B	-55 to 125°C
Reflow temperature, 20 s exposure	245°C
ESD, Human Body Model (HBM)	-2000 to 2000 V

Electrical Characteristics

Parameter limits apply over the operating temp. range, unless otherwise noted.

Parameter	Symbol	Conditions	Min	Typ	Max	Unit
Input range	BUS+ to BUS-	Measured at 7 A, 85°C ambient temperature <sup>[c]</sup>			50	Vdc
Voltage drop	BUS+ to QPI+	Measured at 7 A, 85°C ambient temperature <sup>[c]</sup>			130	mVdc
Voltage drop	BUS- to QPI-	Measured at 7 A, 85°C ambient temperature <sup>[c]</sup>			130	mVdc
Common-mode attenuation		V <sub>BUS</sub> = 28 V, frequency = 1.0 MHz, line impedance = 50 Ω	45			dB
Differential-mode attenuation		V <sub>BUS</sub> = 28 V, frequency = 1.0 MHz, line impedance = 50 Ω	75			dB
Input bias current at 50 V		Input current from BUS+ to BUS-			10	uA

<sup>[c]</sup> See Figure 4 for the current de-rating curve.

Pad Descriptions

Pin Name	Name	Description
8, 9	BUS+	Positive bus potential
1, 10	BUS-	Negative bus potential
6, 7	QPI+	Positive input to the converter
4, 5	QPI-	Negative input to the converter
2, 3	Shield	Shield connects to the system chassis or to a safety ground

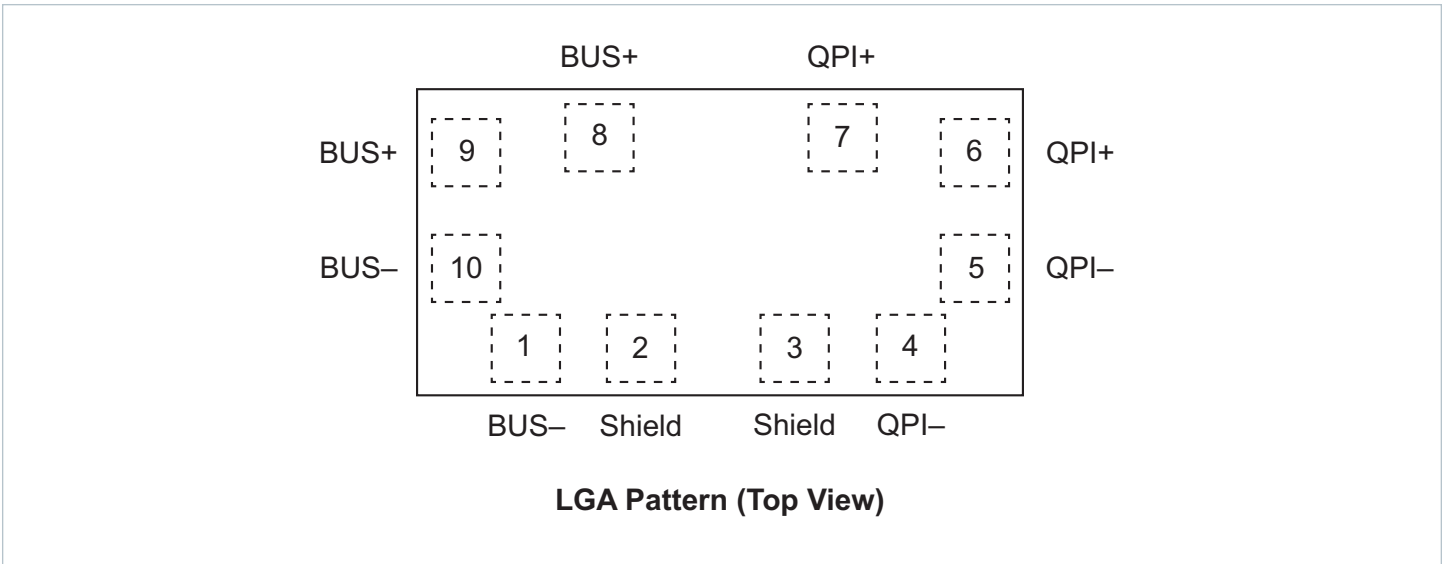

Applications Information

The MQPI-18 was designed specifically to work with Vicor’s MIL PRM (MP028) and VTM (MV036) series of VI Chip® Factorized Power Architecture™ (FPA™) converters to achieve compliance with the MIL-STD 461F standard.

MIL-STD 461F Test Results		
CS101	Conducted susceptibility, power	Leads Passed
CS106	Conducted susceptibility, transients, power leads	Passed
CS114	Bulk cable injection, radio frequency	Passed, 100% load (Figure 4)
CS114	Bulk cable injection, radio frequency	Passed, 78% load (Figure 5)
CS115	Bulk cable injection, radio frequency	Passed
CS116	Damped sinusoid transients	Passed
CS116	Damped sinusoid transients	Passed

CE101 EMI Plots: 108 Watt Load

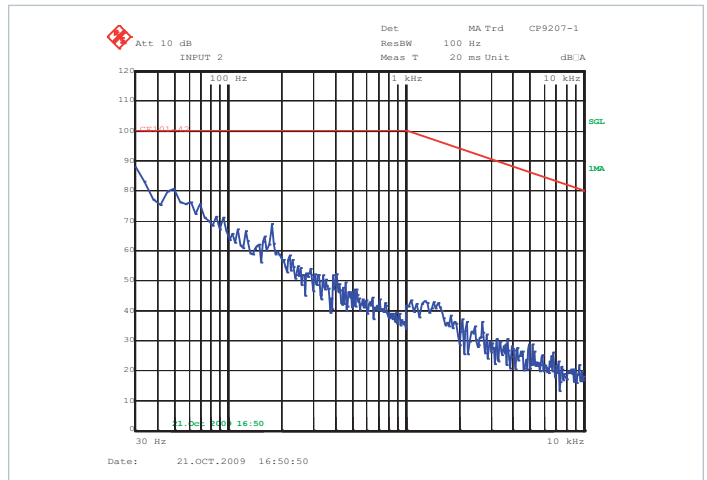
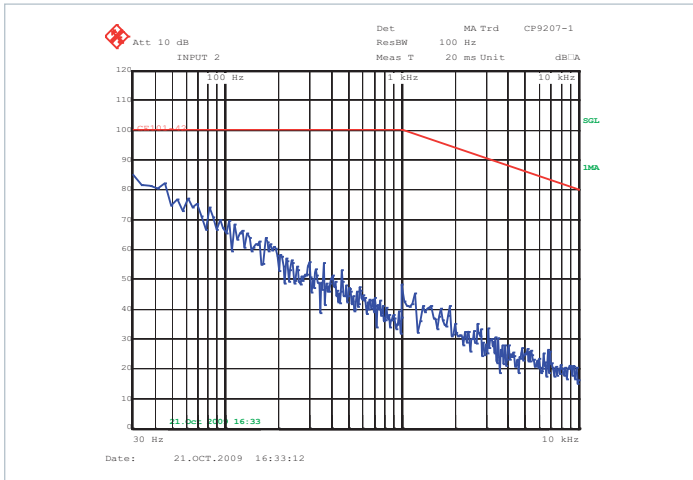

Figure 2 — CE101 EMI plots of the MP028F036M12AL and MV036F120M010, filtered with the MQPI-18LP, + (RED) and -(BLK) leads

CE102 EMI Plots: 108 Watt Load

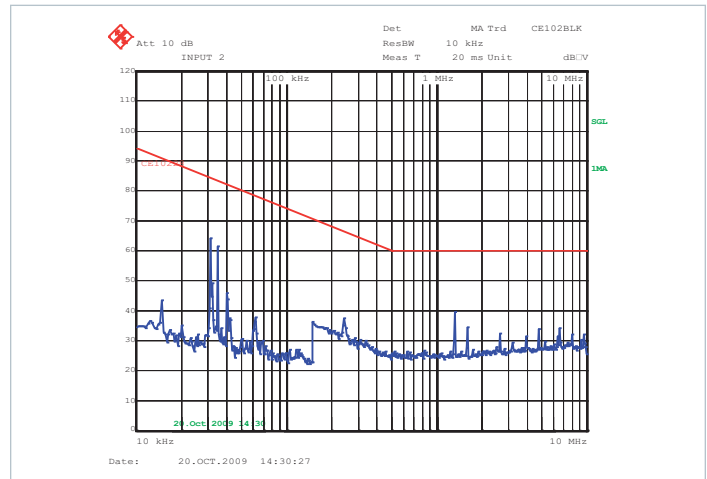
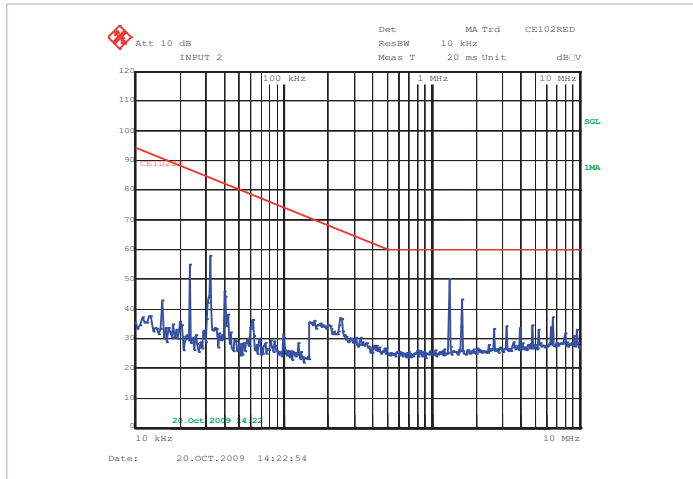

Figure 3 — CE102 EMI plots of the MP028F036M12AL and MV036F120M010, filtered with the MQPI-18LP, + (RED) and -(BLK) leads

Current De-Rating

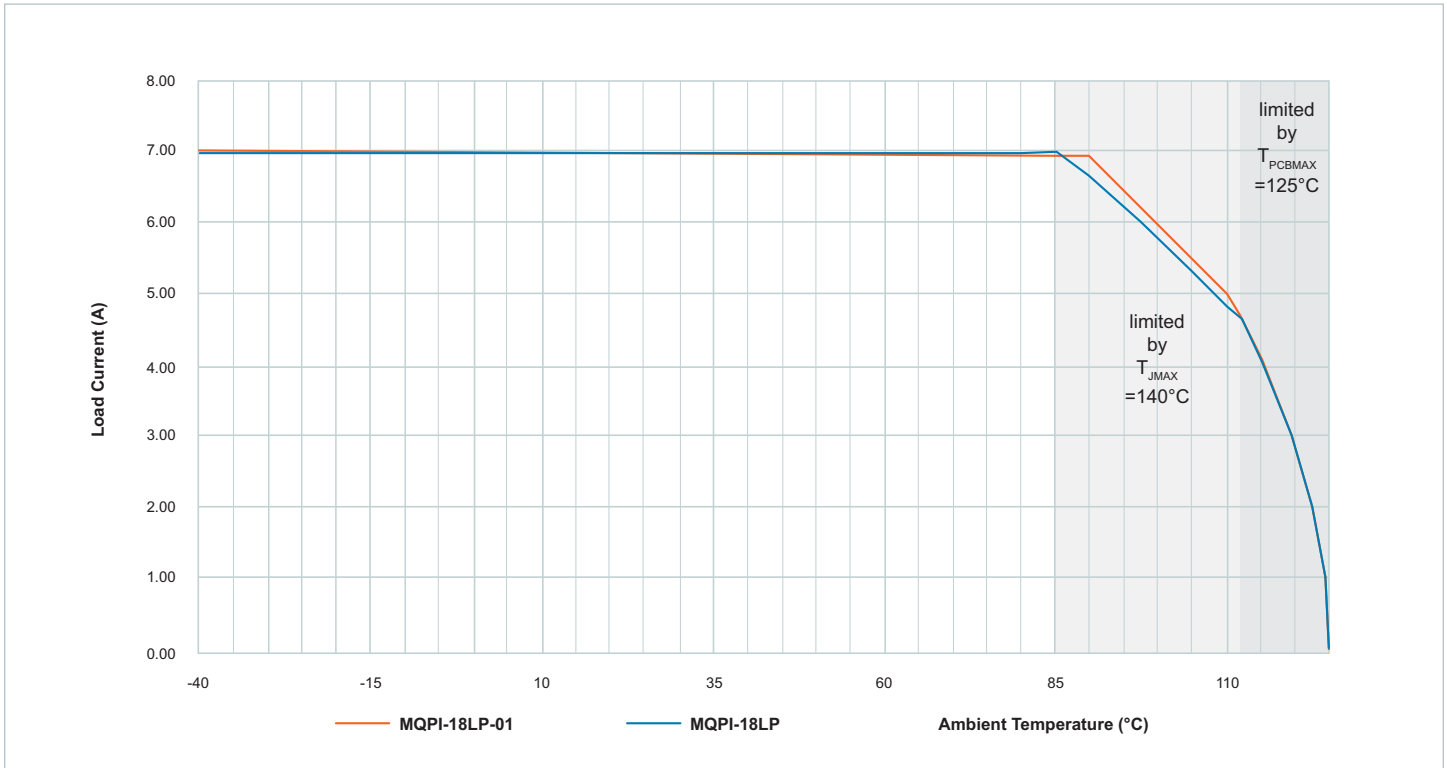

Figure 4 — Current de-rating over ambient temperature range

MQPI-18 Insertion Loss Measurements

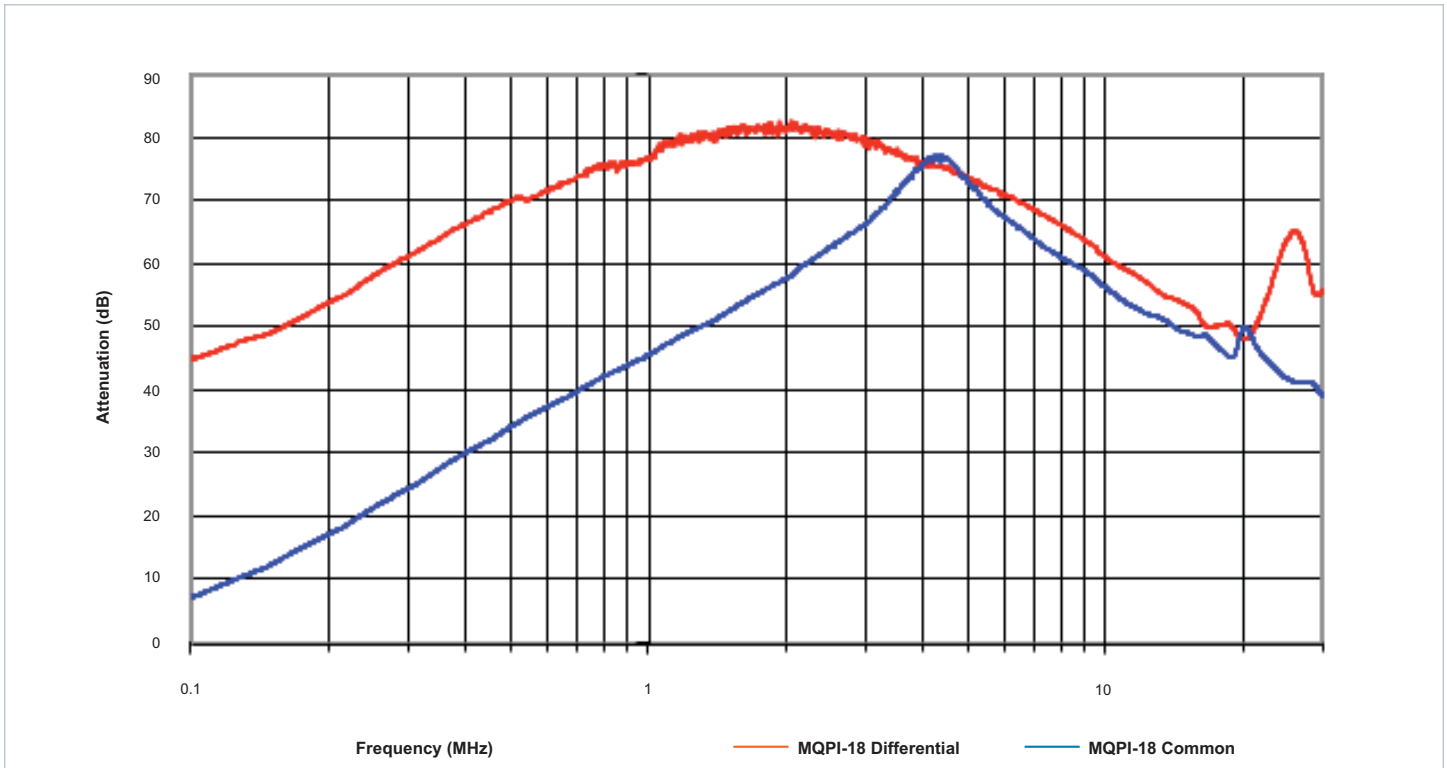

Figure 5 — Attenuation curves into a 50 Ω line impedance, bias from a 48 V bus

MQPI Insertion Loss Test Circuits

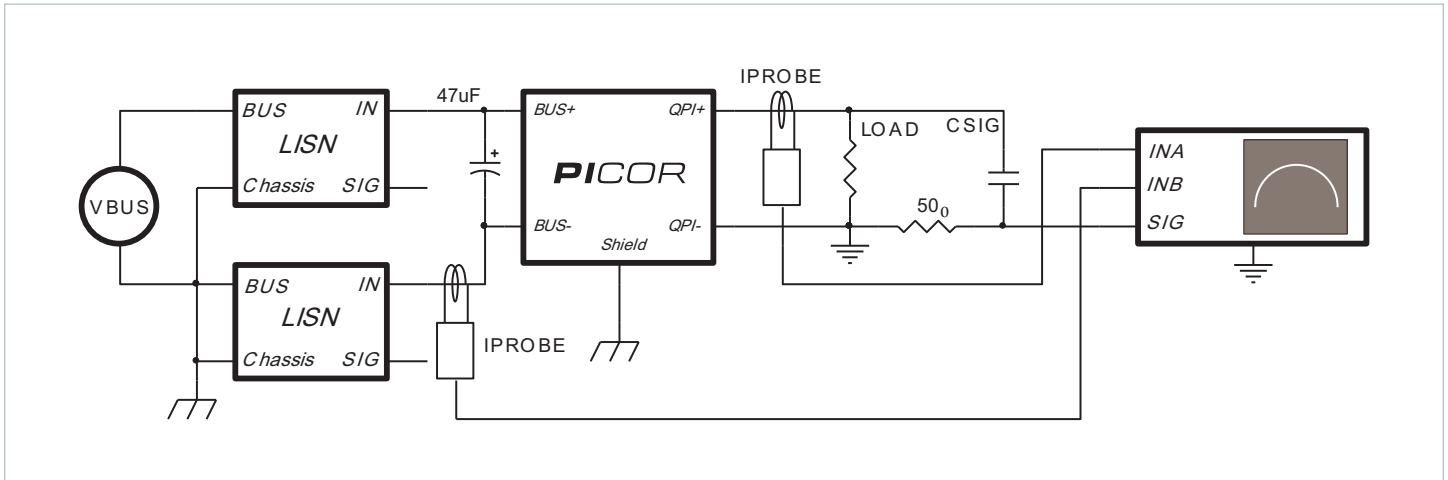

Figure 6 — Test set-up to measure differential-mode EMI currents in Figure 4

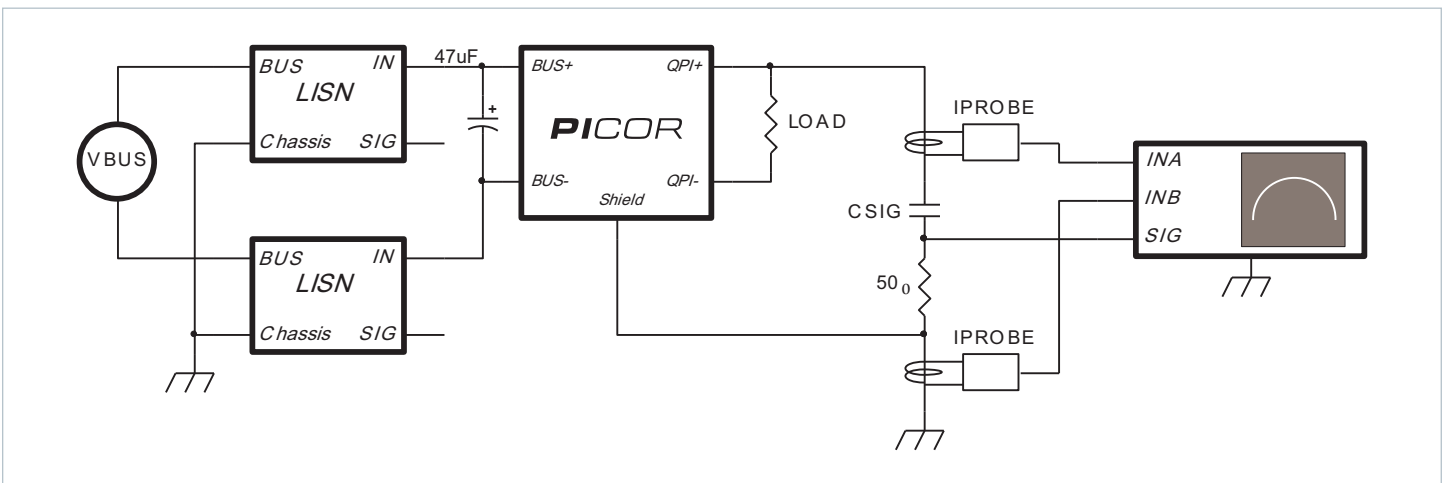

Figure 7 — Test set-up to measure common-mode EMI currents in Figure 4

Mechanical Package Drawings

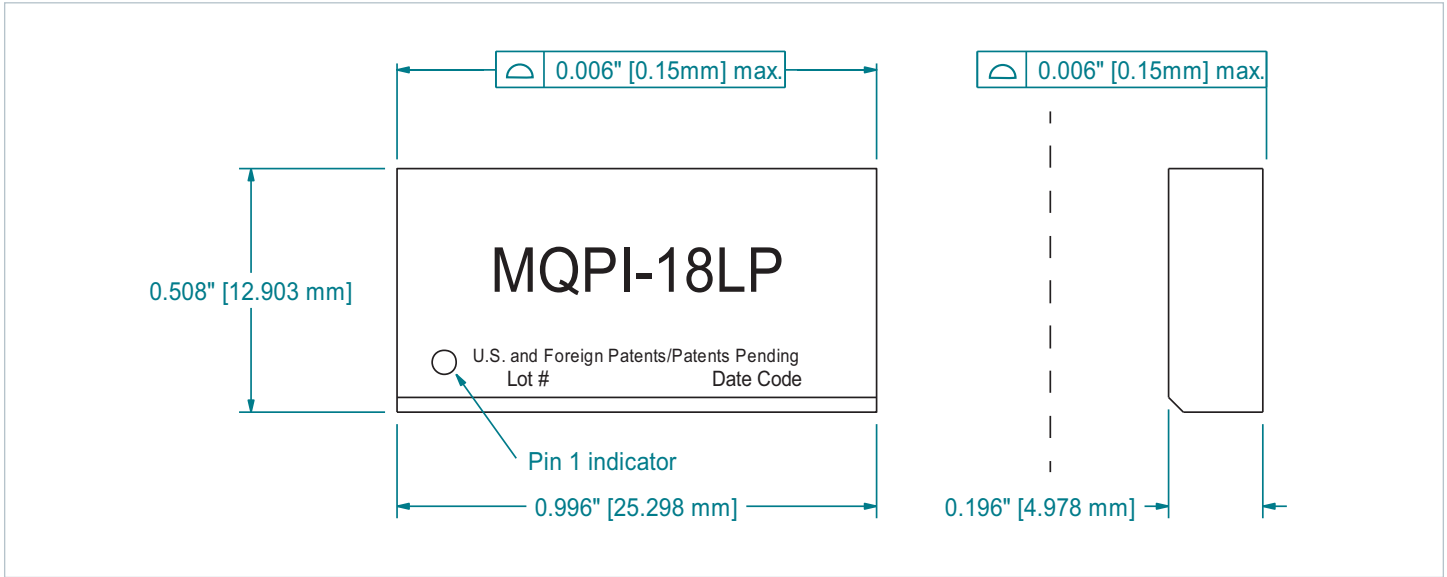

Figure 8 — Bottom view of open-frame (OF) and lidded (LID) products.

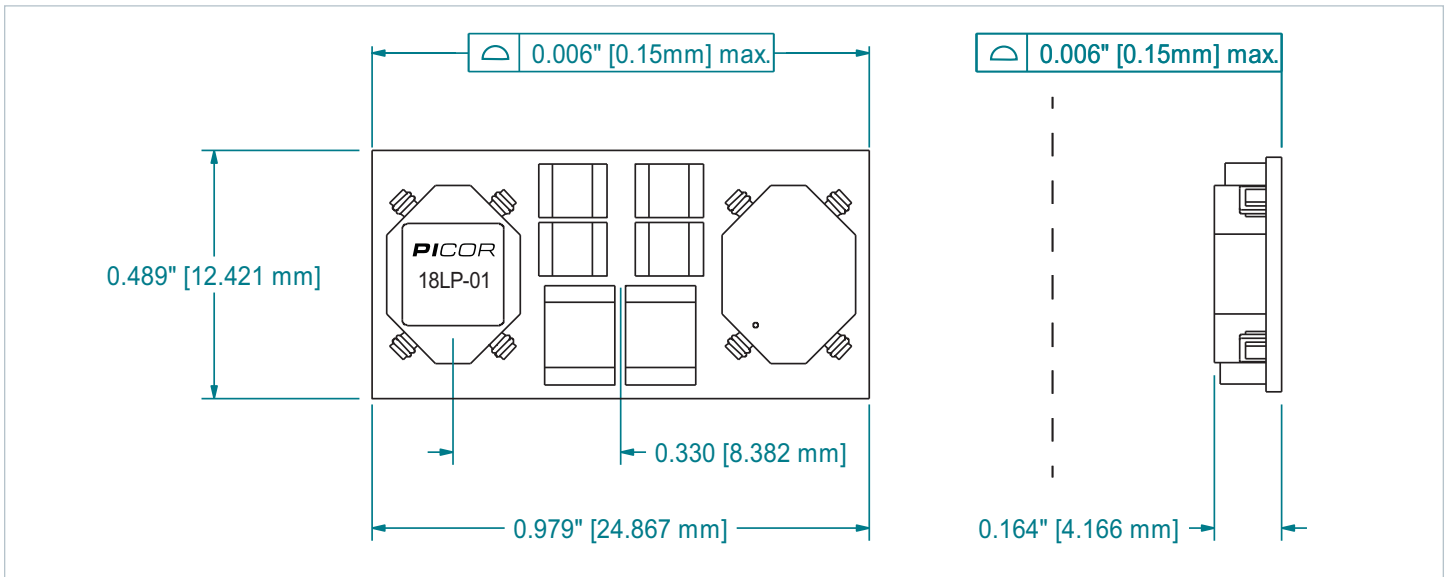

Figure 9 — Recommended receptor and stencil patterns.

Datum	Units	MQPI-18LP	MQPI-18LP-01	Notes
FITS	failure/billion hrs.	16	16	FITS based on the BellCore Standard TR-332
MTBF	million hrs.	62.5	62.5	MTBFs based on the BellCore Standard TR-332
Weight	grams	2.4	2.075	
MSL		3	3	
Peak Reflow Temperature	°C/20 seconds	245	245	IPC/JEDEC J-STD-020D

Pad and Stencil Definitions

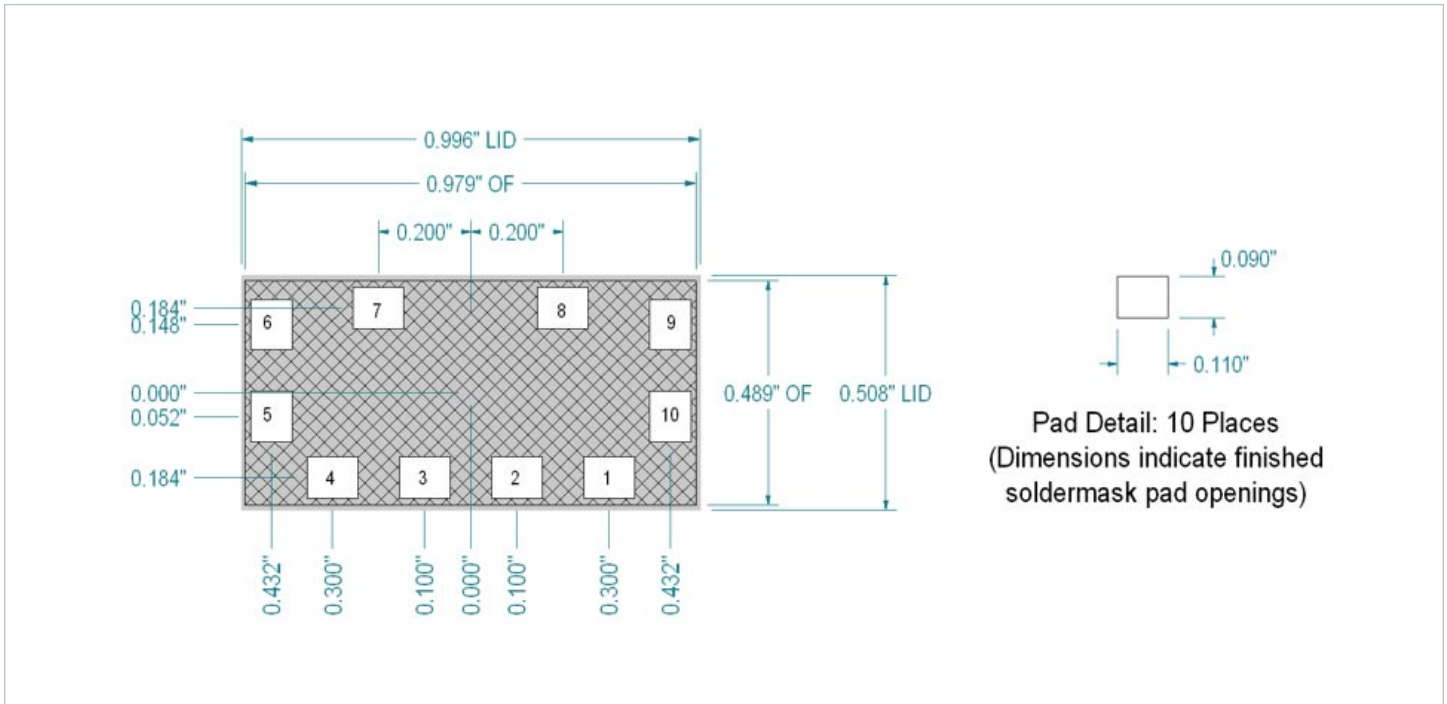

Figure 10 — Bottom view of open-frame (OF) and lidded (LID) products. (All dimensions are in inches)

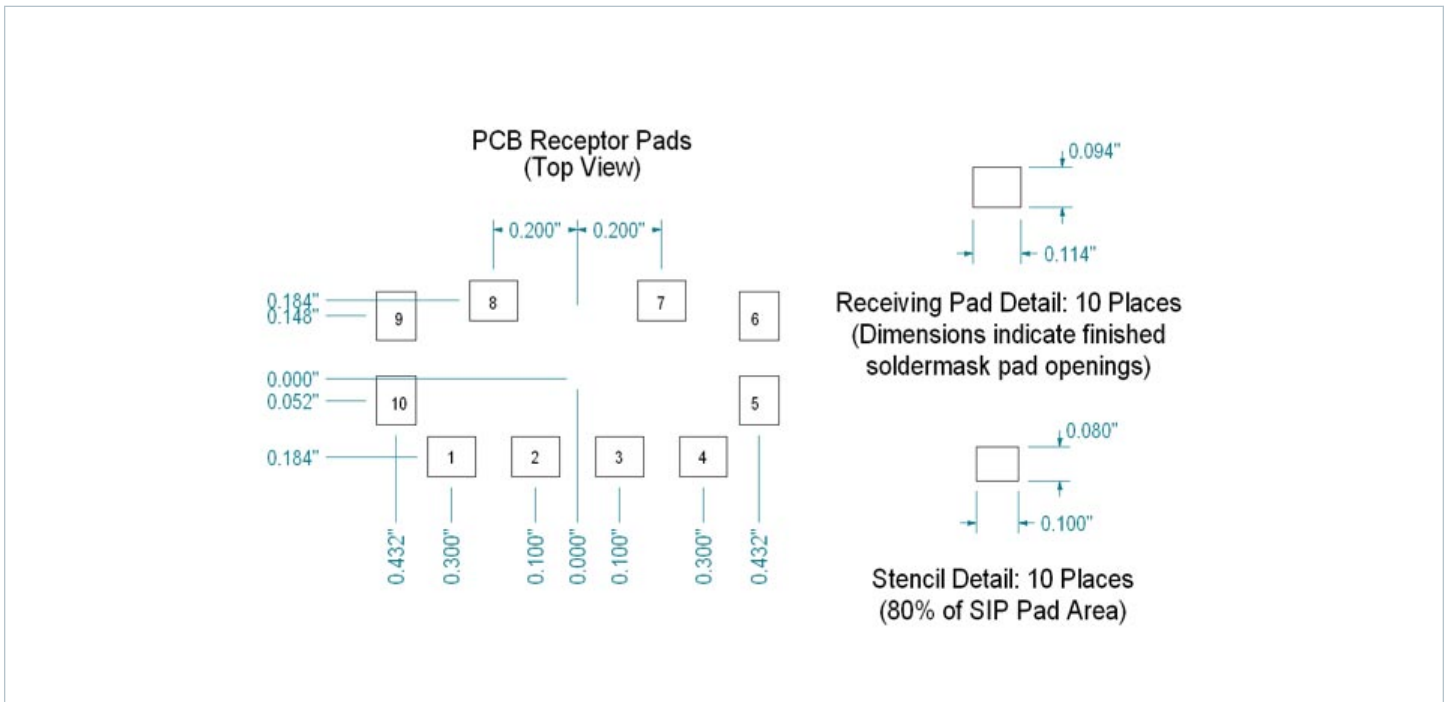
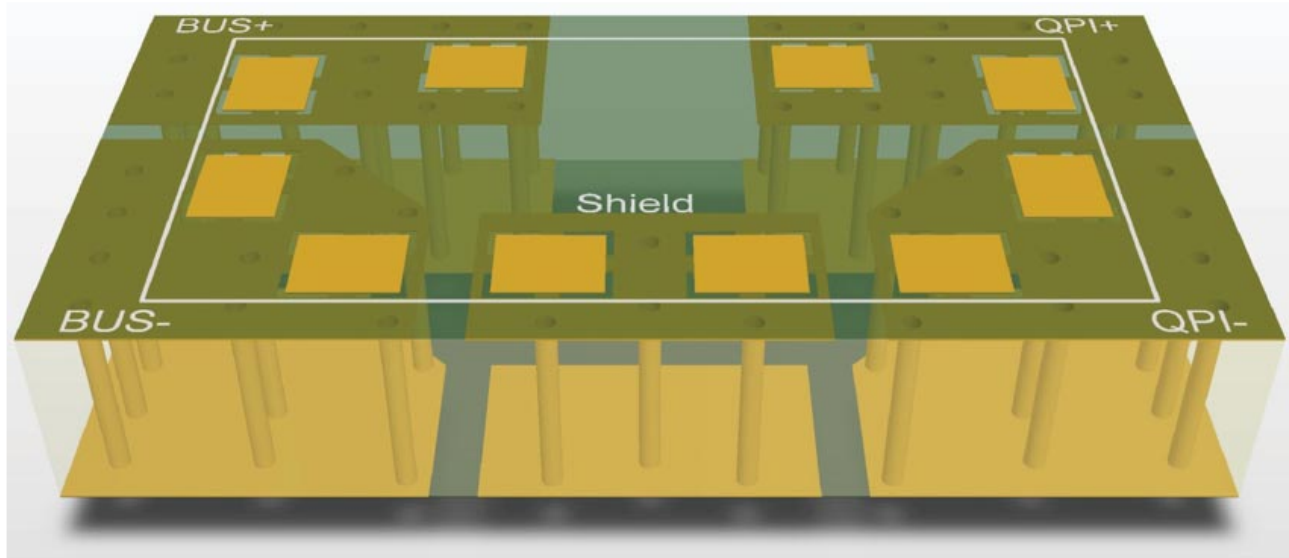

Figure 11 — Recommended receptor and stencil patterns. (All dimensions are in inches)

Stencil definition is based on a 6 mil stencil thickness, 80% of LGA pad area coverage. LGA package dimensions are for both the open-frame and lidded versions of the MQPI-18.



## MQPI-18 PCB Layout Recommendations



**Figure 12** — 3D view of paralleling planes underneath the MQPI-18

The filtering performance of the MQPI-18 is sensitive to capacitive coupling between its input and output pins. Parasitic plane capacitance must be kept below one pico-Farad between inputs and outputs using the layout shown above and the recommendations described below to achieve maximum conducted EMI performance.

To avoid capacitive coupling between input and output pins, there should not be any planes or large traces that run under both input and output pins, such as a ground plane or power plane. For example, if there are two signal planes or large traces where one trace runs under the input pins, and the other under the output pins, and both planes overlap in another area, they will cause capacitive coupling between input and output pins. Also, planes that run under both input and outputs pins, but do not cross, can cause capacitive coupling if they are capacitively by-passed together. Figure 11 shows

the recommended PCB layout on a two-layer board. Here, the top layer planes are duplicated on the bottom layer so that there can be no overlapping of input and output planes. This method can be used for boards of greater layer count.

#### Post Solder Cleaning

Picor's MQPI-18LP SiPs are not hermetically sealed and must not be exposed to liquid, including but not limited to cleaning solvents, aqueous washing solutions or pressurized sprays. When soldering, it is recommended that no-clean flux solder be used, as this will ensure that potentially corrosive mobile ions will not remain on, around, or under the module following the soldering process. For applications where the end product must be cleaned in a liquid solvent, Picor recommends using the MQPI-18LP-01, open-frame version of the EMI filter.

**Vicor's comprehensive line of power solutions includes high density AC-DC and DC-DC modules and accessory components, fully configurable AC-DC and DC-DC power supplies, and complete custom power systems.**

Information furnished by Vicor is believed to be accurate and reliable. However, no responsibility is assumed by Vicor for its use. Vicor makes no representations or warranties with respect to the accuracy or completeness of the contents of this publication. Vicor reserves the right to make changes to any products, specifications, and product descriptions at any time without notice. Information published by Vicor has been checked and is believed to be accurate at the time it was printed; however, Vicor assumes no responsibility for inaccuracies. Testing and other quality controls are used to the extent Vicor deems necessary to support Vicor's product warranty. Except where mandated by government requirements, testing of all parameters of each product is not necessarily performed.

**Specifications are subject to change without notice.**

**Vicor's Standard Terms and Conditions**

All sales are subject to Vicor's Standard Terms and Conditions of Sale, which are available on Vicor's website or upon request.

**Product Warranty**

In Vicor's standard terms and conditions of sale, Vicor warrants that its products are free from non-conformity to its Standard Specifications (the "Express Limited Warranty"). This warranty is extended only to the original Buyer for the period expiring two (2) years after the date of shipment and is not transferable.

UNLESS OTHERWISE EXPRESSLY STATED IN A WRITTEN SALES AGREEMENT SIGNED BY A DULY AUTHORIZED VICOR SIGNATORY, VICOR DISCLAIMS ALL REPRESENTATIONS, LIABILITIES, AND WARRANTIES OF ANY KIND (WHETHER ARISING BY IMPLICATION OR BY OPERATION OF LAW) WITH RESPECT TO THE PRODUCTS, INCLUDING, WITHOUT LIMITATION, ANY WARRANTIES OR REPRESENTATIONS AS TO MERCHANTABILITY, FITNESS FOR PARTICULAR PURPOSE, INFRINGEMENT OF ANY PATENT, COPYRIGHT, OR OTHER INTELLECTUAL PROPERTY RIGHT, OR ANY OTHER MATTER.

This warranty does not extend to products subjected to misuse, accident, or improper application, maintenance, or storage. Vicor shall not be liable for collateral or consequential damage. Vicor disclaims any and all liability arising out of the application or use of any product or circuit and assumes no liability for applications assistance or buyer product design. Buyers are responsible for their products and applications using Vicor products and components. Prior to using or distributing any products that include Vicor components, buyers should provide adequate design, testing and operating safeguards.

Vicor will repair or replace defective products in accordance with its own best judgment. For service under this warranty, the buyer must contact Vicor to obtain a Return Material Authorization (RMA) number and shipping instructions. Products returned without prior authorization will be returned to the buyer. The buyer will pay all charges incurred in returning the product to the factory. Vicor will pay all reshipment charges if the product was defective within the terms of this warranty.

**Life Support Policy**

VICOR'S PRODUCTS ARE NOT AUTHORIZED FOR USE AS CRITICAL COMPONENTS IN LIFE SUPPORT DEVICES OR SYSTEMS WITHOUT THE EXPRESS PRIOR WRITTEN APPROVAL OF THE CHIEF EXECUTIVE OFFICER AND GENERAL COUNSEL OF VICOR CORPORATION. As used herein, life support devices or systems are devices which (a) are intended for surgical implant into the body, or (b) support or sustain life and whose failure to perform when properly used in accordance with instructions for use provided in the labeling can be reasonably expected to result in a significant injury to the user. A critical component is any component in a life support device or system whose failure to perform can be reasonably expected to cause the failure of the life support device or system or to affect its safety or effectiveness. Per Vicor Terms and Conditions of Sale, the user of Vicor products and components in life support applications assumes all risks of such use and indemnifies Vicor against all liability and damages.

**Intellectual Property Notice**

Vicor and its subsidiaries own Intellectual Property (including issued U.S. and Foreign Patents and pending patent applications) relating to the products described in this data sheet. No license, whether express, implied, or arising by estoppel or otherwise, to any intellectual property rights is granted by this document. Interested parties should contact Vicor's Intellectual Property Department.

The products described on this data sheet are protected by the following U.S. Patents Number:  
6,898,092

**Vicor Corporation**  
25 Frontage Road  
Andover, MA 01810 USA

**Picor Corporation**  
51 Industrial Drive  
North Smithfield, RI 02896 USA

**email**

Customer Service: [custserv@vicorpower.com](mailto:custserv@vicorpower.com)

Technical Support: [apps@vicorpower.com](mailto:apps@vicorpower.com)

## X-ON Electronics

Largest Supplier of Electrical and Electronic Components

*Click to view similar products for [Power Line Filters](#) category:*

*Click to view products by [Vicor](#) manufacturer:*

Other Similar products are found below :

[6609019-3](#) [6609026-5](#) [6609030-6](#) [6609973-2](#) [D30A](#) [7-1609090-5](#) [F2810](#) [F4456A](#) [F7382Z](#) [F7863Z](#) [FAHAV3100ZC000](#) [806276](#) [FN2020B-1-06](#) [FN2080B-10-06](#) [FN2410H-32-33](#) [FN2410H-80-34](#) [FP144](#) [FS4153-20-06](#) [FS4353-500-99](#) [12-MMB-030-11-D](#) [DB4-393](#) [15811T200](#)  
[20B1](#) [LC630](#) [2B1](#) [1609080-2](#) [1609993-8](#) [1-6609070-1](#) [F1100AA02](#) [F1150CC10](#) [F1500CA10](#) [F1500CA15](#) [F4041Z](#) [F7585E](#) [1B1](#)  
[FN2070A-16-06](#) [FN2090A-20-06](#) [FN2090B-12-06](#) [FN2090Z-1-06](#) [FN2410H-25-33](#) [FN2410H-60-34](#) [FN2410H-8-44](#) [FN2412H-8-44](#)  
[FN323B-6-01](#) [FN3258H-130-35](#) [FN610R-3-06](#) [20EHQ7](#) [20EHZ7](#) [20K1](#) [30B6](#)