



28V_{IN}, 3.3 to 15V_{OUT}, ZVS Isolated Converter Module Family

Product Description

The ZVS Isolated Converter Module Series consists of high-density isolated DC-DC converters implementing Zero-Voltage Switching topology.

The 28V_{IN} series operates over a wide range input of 16V to 50V_{DC}, delivering 50W of output power, yielding an unprecedented power density of 334W/in³.

These converter modules are surface mountable and only ~0.5in square in area achieving ~50% space reduction versus conventional solutions.

| Device | Output Voltage | | I _{OUT} Max |
|--------------------------------|----------------|--------------|----------------------|
| | Set | Range | |
| PI3108-00-HVMZ | 3.3V | 2.97 – 3.63V | 10A |
| PI3109-00-HVMZ | 5V | 4 – 5.5V | 10A |
| PI3106-00-HVMZ | 12V | 9.6 – 13.2V | 4.2A |
| PI3111-00-HVMZ | 15V | 12 – 16.5V | 3.33A |

The switching frequency of 900kHz allows for small input and output filter components which further reduces the total size and cost of the overall system solution. The output voltage is sensed and fed back to the internal controller using a high performance isolated magnetic feedback scheme which allows for high bandwidth and good common mode noise immunity.

The PI31xx-00-HVMZ series requires no external feedback compensation and offers a total solution with a minimum number of external components. A rich feature set is offered, including output voltage trim capability, output overvoltage protection, adjustable soft start, overcurrent protection with auto-restart, over and under input voltage lockout and a temperature monitoring and protection function that provides an analog voltage proportional to the die temperature as well as shut down and alarm capabilities.

Features & Benefits

- Efficiency up to 88%
- High switching frequency minimizes input filter requirements and reduces output capacitance
- Proprietary “Double-Clamped” ZVS Buck-Boost Topology
- Proprietary isolated magnetic feedback
- Small footprint (0.57in²) enables PCB area savings
- Very low profile (0.265in)
- Wide input voltage range operation (16 – 50V_{DC})
- On/Off Control, positive logic
- Wide trim range +10/-20% most models
- Temperature Monitor (TM) & Overtemperature Protection (OTP)
- Input UVLO & OVLO and output OVP
- Overcurrent protection with auto restart
- Adjustable soft start
- 2250V_{DC} input-to-output isolation

Applications

- Wide Temperature, Aerospace & Defense Applications
- Space-Constrained Systems
- Isolated Board-Level Power

Package Information

- Surface Mountable 0.87 x 0.65 x 0.265in package
- Weight = 7.8 grams



Contents

| | |
|--|----|
| Order Information | 3 |
| Absolute Maximum Ratings | 4 |
| Functional Block Diagram | 5 |
| Pin Description | 6 |
| Package Pinout | 6 |
| PI3108-00-HVMZ Electrical Characteristics | 7 |
| PI3109-00-HVMZ Electrical Characteristics | 11 |
| PI3106-00-HVMZ Electrical Characteristics | 15 |
| PI3111-00-HVMZ Electrical Characteristics | 19 |
| Functional Description | 23 |
| Input Power Pins IN(+) and IN(-) | 23 |
| ENABLE | 23 |
| TRIM/SS Pin | 23 |
| TM | 24 |
| SGND | 24 |
| Output Power Pins +OUT and -OUT | 24 |
| Package Outline & Recommended PCB Land Pattern | 25 |
| Product Warranty | 26 |

Order Information

| Part Number | V _{IN} | V _{OUT} | I _{OUT} Max | Package | Transport Media |
|----------------|-----------------|------------------|----------------------|-----------------------|-----------------|
| PI3108-00-HVMZ | 16 – 50V | 3.3V | 10A | 0.87 x 0.65 x 0.265in | TRAY |
| PI3109-00-HVMZ | 16 – 50V | 5V | 10A | 0.87 x 0.65 x 0.265in | TRAY |
| PI3106-00-HVMZ | 16 – 50V | 12V | 4.2A | 0.87 x 0.65 x 0.265in | TRAY |
| PI3111-00-HVMZ | 16 – 50V | 15V | 3.33A | 0.87 x 0.65 x 0.265in | TRAY |
| Also Available | | | | | |
| PI3101-00-HVIZ | 36 – 75V | 3.3V | 18A | 0.87 x 0.65 x 0.265in | TRAY |
| PI3105-00-HVIZ | 36 – 75V | 12V | 5A | 0.87 x 0.65 x 0.265in | TRAY |
| PI3110-01-HVIZ | 41 – 57V | 18V | 3.3A | 0.87 x 0.65 x 0.265in | TRAY |
| PI3109-01-HVIZ | 18 – 36V | 5V | 10A | 0.87 x 0.65 x 0.265in | TRAY |
| PI3106-01-HVIZ | 18 – 36V | 12V | 4.2A | 0.87 x 0.65 x 0.265in | TRAY |

Absolute Maximum Ratings

| Name | Rating |
|---|---|
| +IN to -IN Max Operating Voltage | -1.0 to 50V _{DC} (operating) |
| +IN to -IN Max Peak Voltage | 55V _{DC} (non-operating, 12.5ms) |
| ENABLE to -IN | -0.3 to 6.0V _{DC} |
| TM to -IN | -0.3 to 6.0V _{DC} |
| TRIM/SS to -IN | -0.3 to 6.0V _{DC} |
| +OUT to -OUT | See relevant model output section |
| Isolation Voltage (+IN/-IN to +OUT/-OUT) | 2250V _{DC} |
| Continuous Output Current | See relevant model output section |
| Peak Output Current | See relevant model output section |
| Operating Junction Temperature | -55 to 125°C |
| Storage Temperature | -65 to 125°C |
| Case Temperature During Reflow | 245°C |
| Peak Compressive Force Applied to Case (Z-axis) | 3lbs (supported by J-lead only) |

Functional Block Diagram

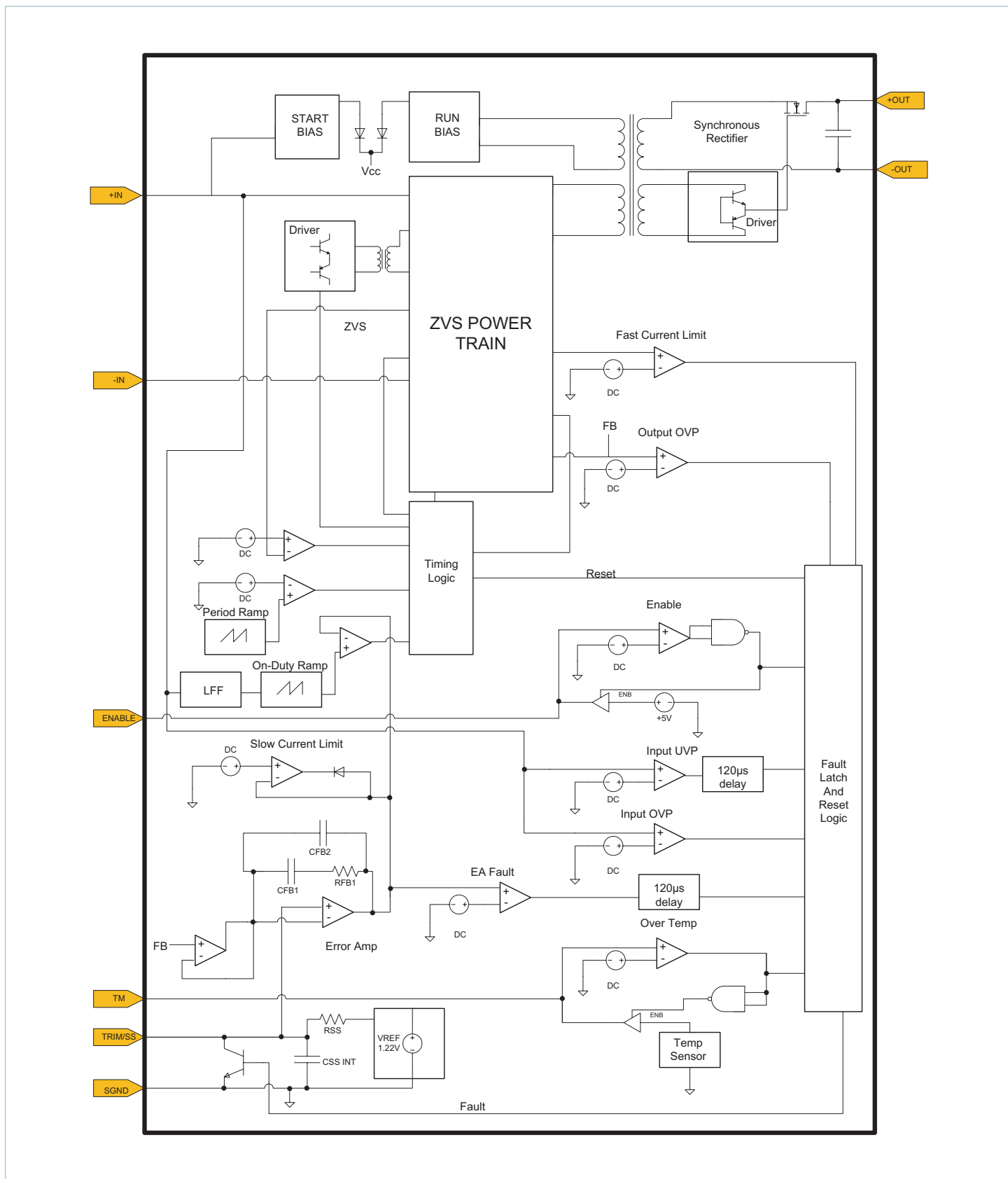

Pin Description

| Pin Name | Description |
|----------|---|
| +IN | Primary side positive input voltage terminals. |
| -IN | Primary side negative input voltage terminals. |
| ENABLE | Converter enable option, functions as 5V reference and on / off control pin. Pull low for off. |
| TRIM/SS | External soft-start pin and trim function. Connect to SGND or ENABLE through resistor for trim up or trim down. |
| TM | Temperature measurement output pin. |
| SGND | Signal ground, primary side referenced. |
| +OUT | Isolated secondary DC output voltage positive terminals. |
| -OUT | Isolated secondary DC output voltage negative terminals. |

Package Pinout



PI3108-00-HVMZ Electrical Characteristics

Unless otherwise specified: $16V < V_{IN} < 50V$, $0A < I_{OUT} < 10A$, $-55^{\circ}C < T_{CASE} < 100^{\circ}C$ [a]

| Parameter | Symbol | Conditions | Min | Typ | Max | Unit |
|--|-----------------------------|---|------|-------|------|-----------|
| Input Specifications | | | | | | |
| Input Voltage Range | V_{IN} | | 16 | 28 | 50 | V_{DC} |
| Input dV/dt [a] | V_{INDVDT} | $V_{IN} = 50V$ | | | 1.0 | $V/\mu s$ |
| Input Undervoltage Turn-on | V_{UVON} | $I_O = 10A$ | 14.5 | 15.3 | 16 | V_{DC} |
| Input Undervoltage Turn-off | V_{UVOFF} | $I_O = 10A$ | 13.5 | 14.1 | 15.2 | V_{DC} |
| Input Undervoltage Hysteresis | V_{UVH} | $I_O = 10A$ | | 1.2 | | V_{DC} |
| Input Overvoltage Turn-on | V_{OVON} | $I_O = 10A$ | 50 | 52.5 | 54 | V_{DC} |
| Input Overvoltage Turn-off | V_{OVOFF} | $I_O = 10A$ | 51 | 53.7 | 55 | V_{DC} |
| Input Overvoltage Hysteresis | V_{OVH} | $I_O = 10A$ | | 1.2 | | V_{DC} |
| Input Quiescent Current | I_Q | $V_{IN} = 28V$, $ENABLE = 0V$ | | 2 | | mA_{DC} |
| Input Idling Power | P_{IDLE} | $V_{IN} = 28V$, $I_{OUT} = 0A$ | | 2.6 | | W |
| Input Standby Power | P_{SBY} | $V_{IN} = 28V$, $ENABLE = 0V$ | | 0.048 | | W |
| Input Current Full Load | I_{IN} | $T_{CASE} = 100^{\circ}C$, $I_{OUT} = 10A$, $\eta_{FL} = 86\%$ typical, $V_{IN} = 28V$ | | 1.37 | | A_{DC} |
| Input Reflected Ripple Current | I_{INRR} | $L_{IN} = 0.47\mu H$ $C_{IN} = 100\mu F$ 63V electrolytic + 2 x 4.7 μF 50V X7R ceramic | | 15 | | mApp |
| Recommended Ext Input Capacitance | C_{IN} | $C_{IN} = 100\mu F$ 63V electrolytic + 2 x 4.7 μF 50V X7R ceramic $C_{IN} = C_{bulk} + C_{hf}$ | | 109.4 | | μF |
| Output Specifications | | | | | | |
| Output Voltage Set Point | V_{OUT} | $I_{OUT} = 5A$ | | 3.3 | | V_{DC} |
| Total Output Accuracy | V_{OA} | $-0^{\circ}C < T_{CASE} < 100^{\circ}C$ | -3 | | +3 | % |
| | | $-55^{\circ}C < T_{CASE} < 0^{\circ}C$ | -5 | | +3 | % |
| Output Voltage Trim Range | V_{OAdj} | | -10 | | 10 | % |
| Output Current Range | I_{OUT} | | | | 10 | A_{DC} |
| Overcurrent Protection | I_{OCP} | | 11.0 | 15 | 20 | A_{DC} |
| Efficiency – Full Load | η_{FL} | $T_{CASE} = 100^{\circ}C$, $V_{IN} = 28V$ | 84 | 86 | | % |
| Efficiency – Half Load | η_{HL} | $T_{CASE} = 100^{\circ}C$, $V_{IN} = 28V$ | 80 | 82 | | % |
| Output OVP Set Point | V_{OVP} | | 3.9 | 4.1 | 4.3 | V_{DC} |
| Output Ripple Voltage | V_{ORPP} | $C_{OUT} = 6 \times 10\mu F$ 10V X7R DC-20MHz | | 90 | | mVpp |
| Switching Frequency | f_{SW} | | | 900 | | kHz |
| Output Turn-on Delay Time | t_{ONDLY} | $V_{IN} = V_{UVON}$ to $ENABLE = 5V$; V_{IN} rise time < 1ms | | 80 | | ms |
| Output Turn-off Delay Time | t_{OFFDLY} | $V_{IN} = V_{UVOFF}$ to $ENABLE < 2.35V$ | | 375 | | μs |
| Soft-Start Ramp Time | t_{SS} | $ENABLE = 5V$ to 90% V_{OUT} $C_{REF} = 0$ | | 380 | | μs |
| Maximum Load Capacitance | C_{OUT} | $C_{REF} = 0.22\mu F$, $C_{OUT} = Al$ Electrolytic | | | 4700 | μF |
| Load Transient Deviation | V_{ODV} | $I_{OUT} = 50\%$ step $0.1A/\mu s$ $C_{OUT} = 6 \times 10\mu F$ 10V X7R | | 145 | | mV |
| Load Transient Recovery Time | t_{OVR} | $I_{OUT} = 50\%$ step $0.1A/\mu s$ $C_{OUT} = 6 \times 10\mu F$ 10V X7R $V_{OUT} \leq 1\%$ | | 100 | | μs |
| Maximum Output Power | P_{OUT} | | | 33 | | W |
| Absolute Maximum Output Ratings | | | | | | |
| Name | Rating | | | | | |
| +OUT to -OUT | -0.5V to 6.8V _{DC} | | | | | |
| Continuous Output Current | 10A _{DC} | | | | | |
| Peak Output Current | 20A _{DC} | | | | | |

[a] These parameters are not production tested but are guaranteed by design, characterization and correlation with statistical process control. Unless otherwise specified, ATE tests are completed at room temperature.

[b] Current flow sourced by a pin has a negative sign.

PI3108-00-HVMZ Electrical Characteristics (Cont.)

| Parameter | Symbol | Conditions | Min | Typ | Max | Unit |
|--|----------------|--|------|-------|------|------------------|
| ENABLE | | | | | | |
| DC Voltage Reference Output | V_{ERO} | | 4.65 | 4.9 | 5.15 | V_{DC} |
| Output Current Limit ^[b] | I_{ECL} | ENABLE = 3.3V | -3.3 | -2.6 | -1.9 | mA_{DC} |
| Start Up Current Limit ^[b] | I_{ESL} | ENABLE = 1V | -120 | -90 | -60 | μA |
| Module Enable Voltage | V_{EME} | | 1.95 | 2.5 | 3.05 | V_{DC} |
| Module Disable Voltage | V_{EMD} | | 1.8 | 2.35 | 2.9 | V_{DC} |
| Disable Hysteresis | V_{EDH} | | | 150 | | mV |
| Enable Delay Time | t_{EE} | | | 10 | | μs |
| Disable Delay Time | t_{ED} | | | 10 | | μs |
| Maximum Capacitance | C_{EC} | | | | 1500 | pF |
| Maximum External Toggle Rate | f_{EXT} | | | | 1 | Hz |
| TRIM/SS | | | | | | |
| Trim Voltage Reference | V_{REF} | | | 1.240 | | V_{DC} |
| Internal Capacitance | C_{REFI} | | | 10 | | nF |
| External Capacitance | C_{REF} | | | | 0.22 | μF |
| Internal Resistance | R_{REFI} | | | 10 | | k Ω |
| TM (Temperature Monitor) | | | | | | |
| Temperature Coefficient ^[a] | TM_{TC} | | | 10 | | mV / $^{\circ}K$ |
| Temperature Full Range Accuracy ^[a] | TM_{ACC} | | -5 | | 5 | $^{\circ}K$ |
| Drive Capability | I_{TM} | | -100 | | | μA |
| TM Output Setting | V_{TM} | Ambient Temperature = 300 $^{\circ}K$ | | 3.00 | | V |
| Thermal Specification | | | | | | |
| Junction Temperature Shutdown ^[a] | T_{MAX} | | 130 | 135 | 140 | $^{\circ}C$ |
| Junction-to-Case Thermal Impedance | θ_{J-C} | | | 3 | | $^{\circ}C / W$ |
| Case-to-Ambient Thermal Impedance | θ_{C-A} | Mounted on 9in ² 1oz. Cu 6 layer PCB 25 $^{\circ}C$ | | 9.6 | | $^{\circ}C / W$ |
| Soldering | | | | | | |
| Peak Temperature During Reflow | | MSL 5; time on floor = 48 hours | | | 225 | $^{\circ}C$ |
| | | MSL 6; time on floor = 4 hours | | | 245 | $^{\circ}C$ |
| Regulatory Specification | | | | | | |
| IEC 60950-1:2005 (2nd Edition) | | | | | | |
| EN 60950-1:2006 | | | | | | |
| IEC 61000-4-2 | | | | | | |
| UL60950-1:2007 | | | | | | |
| CAN/CSA C22.2 NO. 60950-1-07 | | | | | | |
| Recommended Input Fuse Rating | I_{FUSE} | Fast acting LITTLEFUSE Nano ² Series Fuse | 4 | | 10 | A |

^[a] These parameters are not production tested but are guaranteed by design, characterization and correlation with statistical process control. Unless otherwise specified, ATE tests are completed at room temperature.

^[b] Current flow sourced by a pin has a negative sign.

PI3108-00-HVMZ Electrical Characteristics (Cont.)

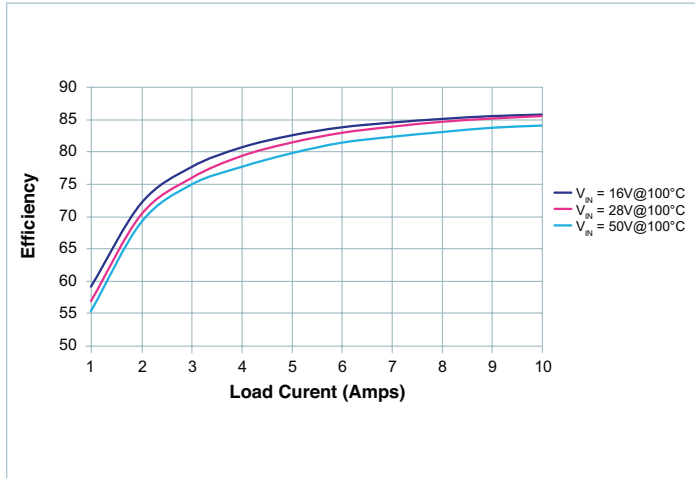

Figure 1 — Conversion efficiency

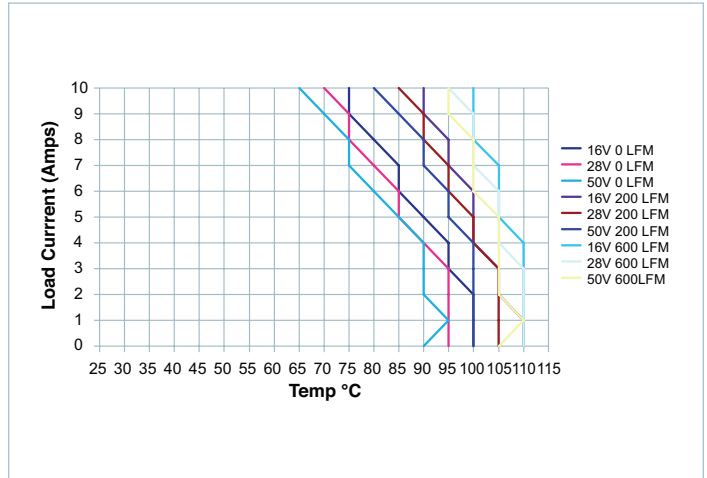

Figure 4 — Load current vs. temperature (11mm heat sink)

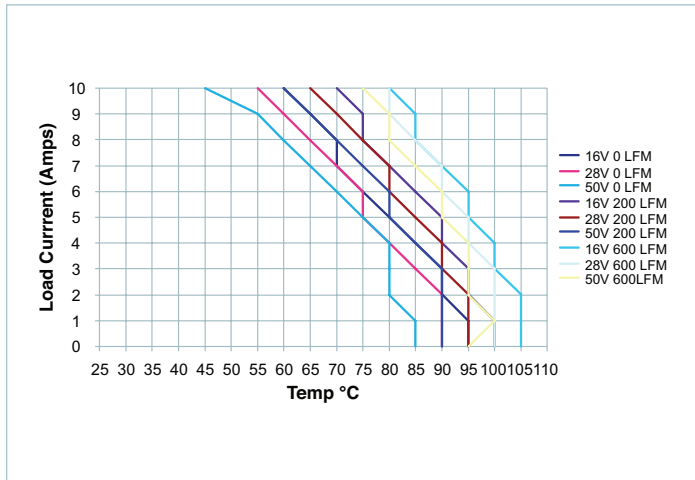

Figure 2 — Load current vs. temperature (without heat sink)

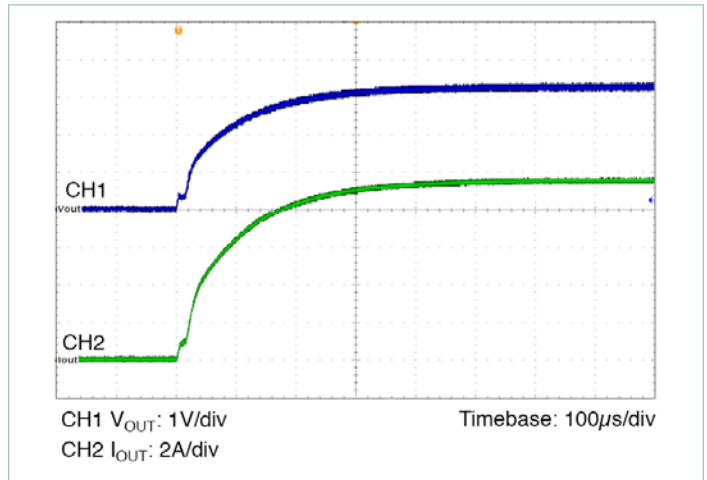

Figure 5 — Start up, $C_{REF} = 0$ ($V_{IN} = 16V$, $I_{OUT} = 10A$, CR, $C_{OUT} = 6 \times 10\mu F$ X7R ceramic)

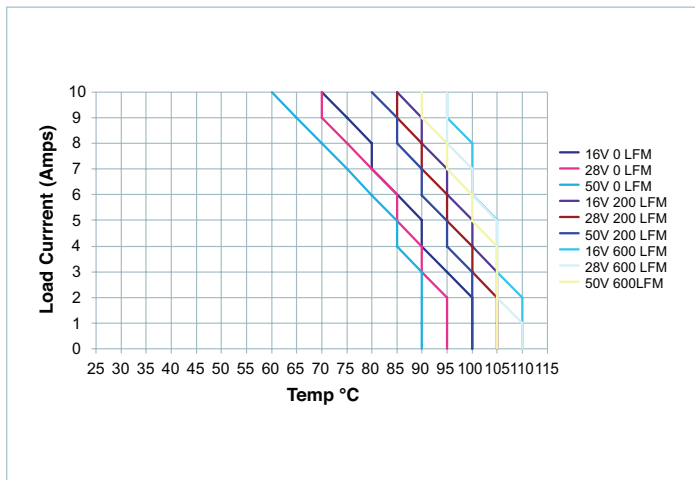

Figure 3 — Load current vs. temperature (6.33mm heat sink)

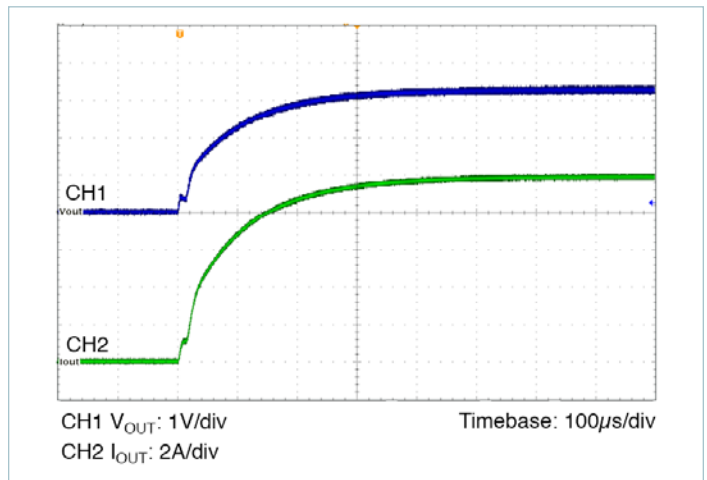

Figure 6 — Start up, $C_{REF} = 0$ ($V_{IN} = 28V$, $I_{OUT} = 10A$, CR, $C_{OUT} = 6 \times 10\mu F$ X7R ceramic)

PI3108-00-HVMZ Electrical Characteristics (Cont.)

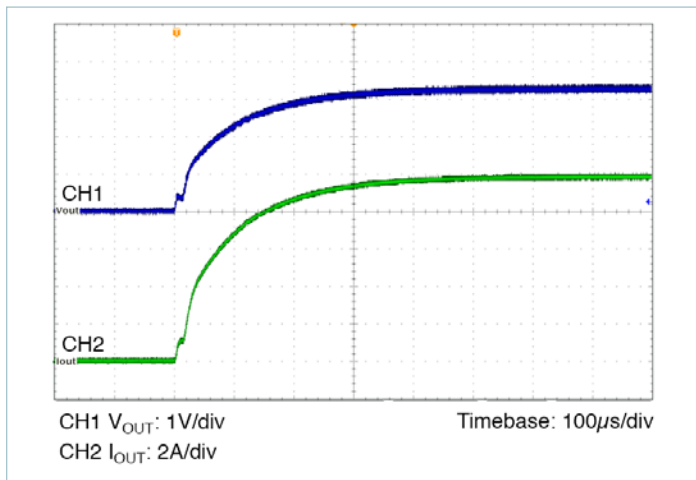

Figure 7 — Start up, $C_{REF} = 0$ ($V_{IN} = 50V$, $I_{OUT} = 10A$, CR, $C_{OUT} = 6 \times 10\mu F$ X7R ceramic)

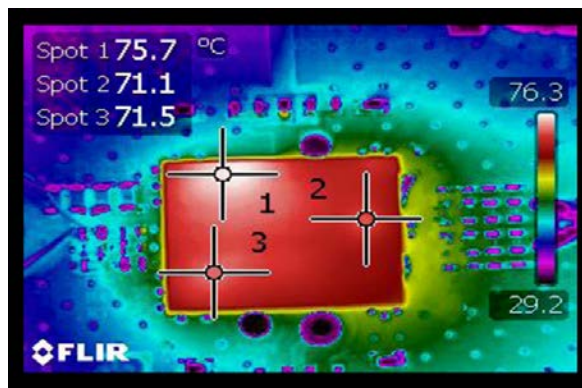

Figure 10 — Thermal image ($V_{IN} = 28V$, $I_{OUT} = 10A$, CR, 0LFM evaluation PCB)

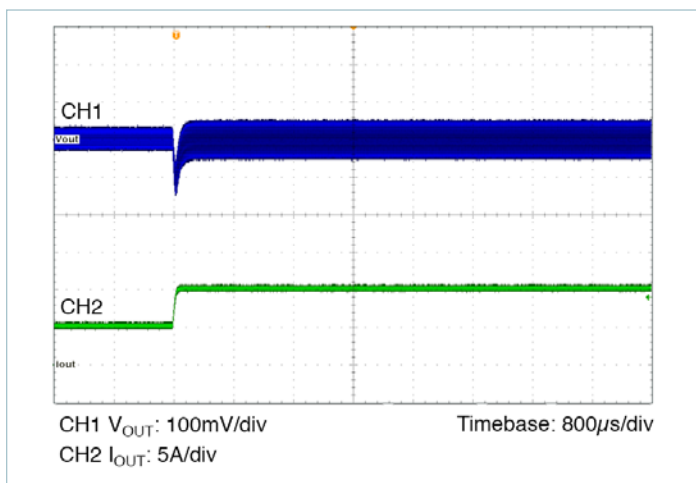

Figure 8 — Transient response ($V_{IN} = 28V$, $I_{OUT} = 5 - 10A$, 0.1A/µs, $C_{OUT} = 6 \times 10\mu F$ X7R ceramic)

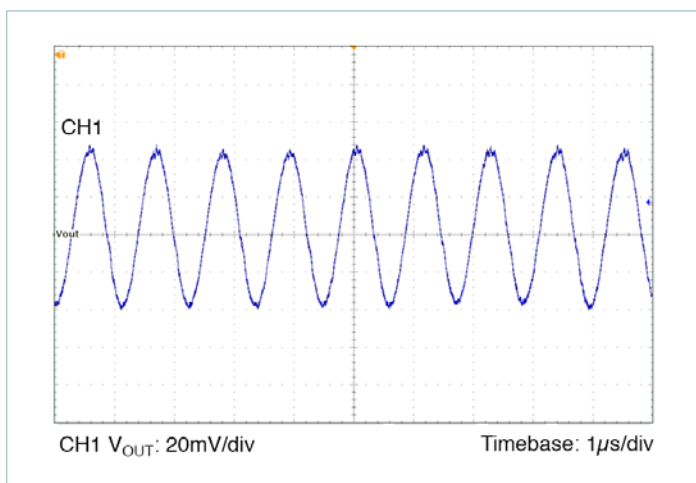

Figure 9 — Output ripple ($V_{IN} = 28V$, $I_{OUT} = 10A$, CR, $C_{OUT} = 6 \times 10\mu F$ X7R ceramic)

PI3109-00-HVMZ Electrical Characteristics

Unless otherwise specified: $16V < V_{IN} < 50V$, $0A < I_{OUT} < 10A$, $-55^{\circ}C < T_{CASE} < 100^{\circ}C$ ^[a]

| Parameter | Symbol | Conditions | Min | Typ | Max | Unit |
|--|-----------------------------|---|------|-------|------|-----------|
| Input Specifications | | | | | | |
| Input Voltage Range | V_{IN} | | 16 | 28 | 50 | V_{DC} |
| Input dV/dt ^[a] | V_{INDVDT} | $V_{IN} = 50V$ | | | 1.0 | $V/\mu s$ |
| Input Undervoltage Turn-on | V_{UVON} | $I_O = 10A$ | 14.5 | 15.3 | 16 | V_{DC} |
| Input Undervoltage Turn-off | V_{UVOFF} | $I_O = 10A$ | 13.5 | 14.1 | 15.2 | V_{DC} |
| Input Undervoltage Hysteresis | V_{UVH} | $I_O = 10A$ | | 1.2 | | V_{DC} |
| Input Overvoltage Turn-on | V_{OVON} | $I_O = 10A$ | 50.0 | 52.5 | 54 | V_{DC} |
| Input Overvoltage Turn-off | V_{OVOFF} | $I_O = 10A$ | 51 | 53.7 | 55 | V_{DC} |
| Input Overvoltage Hysteresis | V_{OVH} | $I_O = 10A$ | | 1.2 | | V_{DC} |
| Input Quiescent Current | I_Q | $V_{IN} = 28V$, ENABLE = 0V | | 2 | | mA_{DC} |
| Input Idling Power | P_{IDLE} | $V_{IN} = 28V$, $I_{OUT} = 0A$ | | 3.5 | | W |
| Input Standby Power | P_{SBY} | $V_{IN} = 28V$, ENABLE = 0V | | 0.056 | | W |
| Input Current Full Load | I_{IN} | $T_{CASE} = 100^{\circ}C$, $I_{OUT} = 10A$, $\eta_{FL} = 88\%$ typical, $V_{IN} = 28V$ | | 2.03 | | A_{DC} |
| Input Reflected Ripple Current | I_{INRR} | $L_{IN} = 0.47\mu H$ $C_{IN} = 100\mu F$ 63V electrolytic + 2 x 4.7 μF 50V X7R ceramic | | 13 | | mApp |
| Recommended Ext Input Capacitance | C_{IN} | $C_{IN} = 100\mu F$ 63V electrolytic + 2 x 4.7 μF 50V X7R ceramic $C_{IN} = C_{bulk} + C_{hf}$ | | 109.4 | | μF |
| Output Specifications | | | | | | |
| Output Voltage Set Point | V_{OUT} | $I_{OUT} = 5A$ | | 5.0 | | V_{DC} |
| Total Output Accuracy | V_{OA} | $-0^{\circ}C < T_{CASE} < 100^{\circ}C$ | -3 | | +3 | % |
| | | $-55^{\circ}C < T_{CASE} < 0^{\circ}C$ | -5 | | +3 | % |
| Output Voltage Trim Range | V_{OAdj} | | -20 | | 10 | % |
| Output Current Range | I_{OUT} | | | | 10 | A_{DC} |
| Overcurrent Protection | I_{OCP} | | 10.8 | 15 | 20 | A_{DC} |
| Efficiency – Full Load | η_{FL} | $T_{CASE} = 100^{\circ}C$, $V_{IN} = 28V$ | 86 | 88 | | % |
| Efficiency – Half Load | η_{HL} | $T_{CASE} = 100^{\circ}C$, $V_{IN} = 28V$ | 83.5 | 85.5 | | % |
| Output OVP Set Point | V_{OVP} | | 6.0 | 6.3 | 6.6 | V_{DC} |
| Output Ripple Voltage | V_{ORPP} | $C_{OUT} = 6 \times 10\mu F$ 10V X7R DC-20MHz | | 135 | | mVpp |
| Switching Frequency | f_{SW} | | | 900 | | kHz |
| Output Turn-on Delay Time | t_{ONDLY} | $V_{IN} = V_{UVON}$ to ENABLE = 5V; V_{IN} rise time < 1ms | | 80 | | ms |
| Output Turn-off Delay Time | t_{OFFDLY} | $V_{IN} = V_{UVOFF}$ to ENABLE < 2.35V | | 375 | | μs |
| Soft-Start Ramp Time | t_{SS} | ENABLE = 5V to 90% V_{OUT} $C_{REF} = 0$ | | 230 | | μs |
| Maximum Load Capacitance | C_{OUT} | $C_{REF} = 0.22\mu F$, $C_{OUT} = Al$ Electrolytic | | | 4700 | μF |
| Load Transient Deviation | V_{ODV} | $I_{OUT} = 50\%$ step 0.1A/ μs $C_{OUT} = 6 \times 10\mu F$ 10V X7R | | 90 | | mV |
| Load Transient Recovery Time | t_{OVR} | $I_{OUT} = 50\%$ step 0.1A/ μs $C_{OUT} = 6 \times 10\mu F$ 10V X7R $V_{OUT} \leq 1\%$ | | 100 | | μs |
| Maximum Output Power | P_{OUT} | | | 50 | | W |
| Absolute Maximum Output Ratings | | | | | | |
| Name | Rating | | | | | |
| +OUT to -OUT | -0.5V to 6.8V _{DC} | | | | | |
| Continuous Output Current | 10A _{DC} | | | | | |
| Peak Output Current | 20A _{DC} | | | | | |

^[a] These parameters are not production tested but are guaranteed by design, characterization and correlation with statistical process control. Unless otherwise specified, ATE tests are completed at room temperature.

^[b] Current flow sourced by a pin has a negative sign.

PI3109-00-HVMZ Electrical Characteristics (Cont.)

| Parameter | Symbol | Conditions | Min | Typ | Max | Unit |
|--|----------------|--|------|-------|------|------------------|
| ENABLE | | | | | | |
| DC Voltage Reference Output | V_{ERO} | | 4.65 | 4.9 | 5.15 | V_{DC} |
| Output Current Limit ^[b] | I_{ECL} | ENABLE = 3.3V | -3.3 | -2.6 | -1.9 | mA_{DC} |
| Start Up Current Limit ^[b] | I_{ESL} | ENABLE = 1V | -120 | -90 | -60 | μA |
| Module Enable Voltage | V_{EME} | | 1.95 | 2.5 | 3.05 | V_{DC} |
| Module Disable Voltage | V_{EMD} | | 1.8 | 2.35 | 2.9 | V_{DC} |
| Disable Hysteresis | V_{EDH} | | | 150 | | mV |
| Enable Delay Time | t_{EE} | | | 10 | | μs |
| Disable Delay Time | t_{ED} | | | 10 | | μs |
| Maximum Capacitance | C_{EC} | | | | 1500 | pF |
| Maximum External Toggle Rate | f_{EXT} | | | | 1 | Hz |
| TRIM/SS | | | | | | |
| Trim Voltage Reference | V_{REF} | | | 1.240 | | V_{DC} |
| Internal Capacitance | C_{REFI} | | | 10 | | nF |
| External Capacitance | C_{REF} | | | | 0.22 | μF |
| Internal Resistance | R_{REFI} | | | 10 | | k Ω |
| TM (Temperature Monitor) | | | | | | |
| Temperature Coefficient ^[a] | TM_{TC} | | | 10 | | mV / $^{\circ}K$ |
| Temperature Full Range Accuracy ^[a] | TM_{ACC} | | -5 | | 5 | $^{\circ}K$ |
| Drive Capability | I_{TM} | | -100 | | | μA |
| TM Output Setting | V_{TM} | Ambient Temperature = 300 $^{\circ}K$ | | 3.00 | | V |
| Thermal Specification | | | | | | |
| Junction Temperature Shutdown ^[a] | T_{MAX} | | 130 | 135 | 140 | $^{\circ}C$ |
| Junction-to-Case Thermal Impedance | θ_{J-C} | | | 3 | | $^{\circ}C / W$ |
| Case-to-Ambient Thermal Impedance | θ_{C-A} | Mounted on 9in ² 1oz. Cu 6 layer PCB 25 $^{\circ}C$ | | 9.1 | | $^{\circ}C / W$ |
| Soldering | | | | | | |
| Peak Temperature During Reflow | | MSL 5; time on floor = 48 hours | | | 225 | $^{\circ}C$ |
| | | MSL 6; time on floor = 4 hours | | | 245 | $^{\circ}C$ |
| Regulatory Specification | | | | | | |
| IEC 60950-1:2005 (2nd Edition) | | | | | | |
| EN 60950-1:2006 | | | | | | |
| IEC 61000-4-2 | | | | | | |
| UL60950-1:2007 | | | | | | |
| CAN/CSA C22.2 NO. 60950-1-07 | | | | | | |
| Recommended Input Fuse Rating | I_{FUSE} | Fast acting LITTLEFUSE Nano ² Series Fuse | 4 | | 10 | A |

^[a] These parameters are not production tested but are guaranteed by design, characterization and correlation with statistical process control. Unless otherwise specified, ATE tests are completed at room temperature.

^[b] Current flow sourced by a pin has a negative sign.

PI3109-00-HVMZ Electrical Characteristics (Cont.)

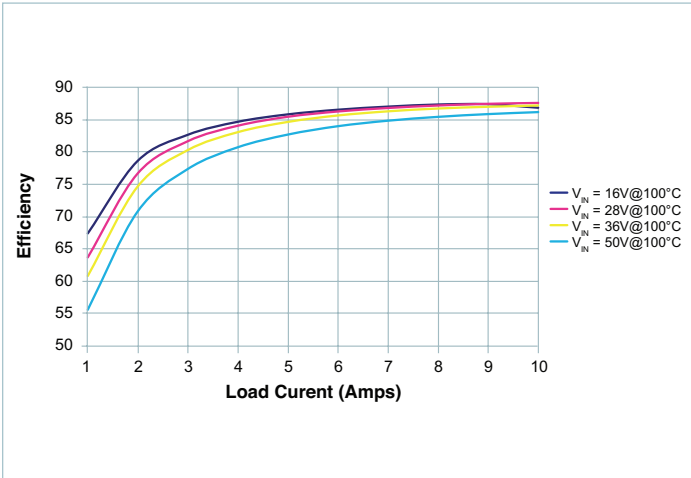

Figure 11 — Conversion efficiency

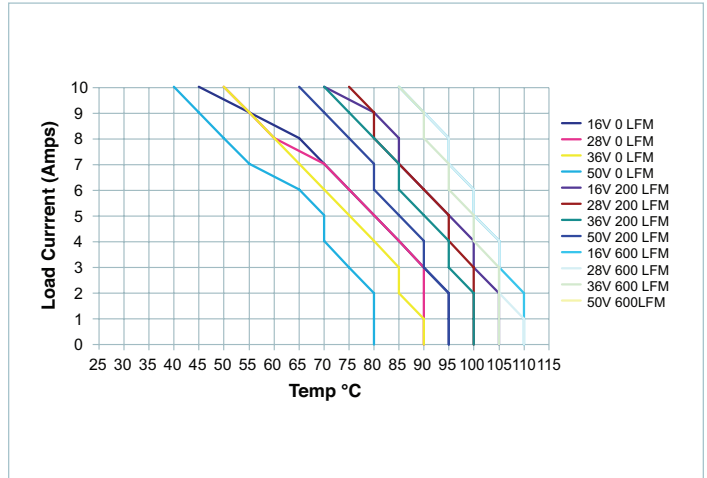

Figure 14 — Load current vs. temperature (11mm heat sink)

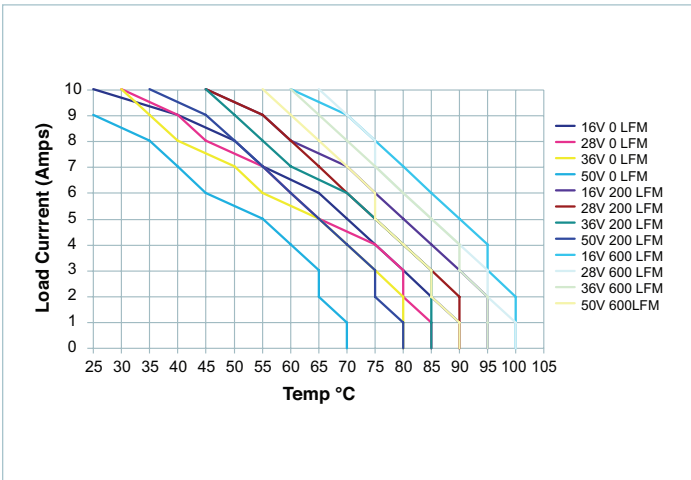

Figure 12 — Load current vs. temperature (without heat sink)

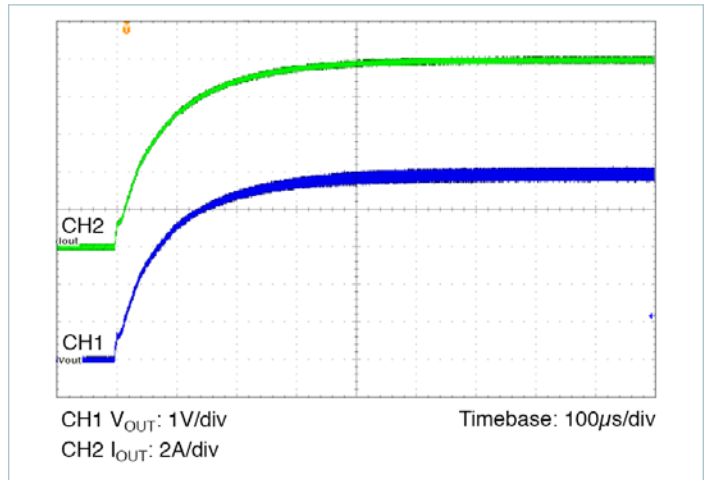

Figure 15 — Start up, $C_{REF} = 0$ ($V_{IN} = 16V$, $I_{OUT} = 10A$, CR, $C_{OUT} = 6 \times 10\mu F$ X7R ceramic)

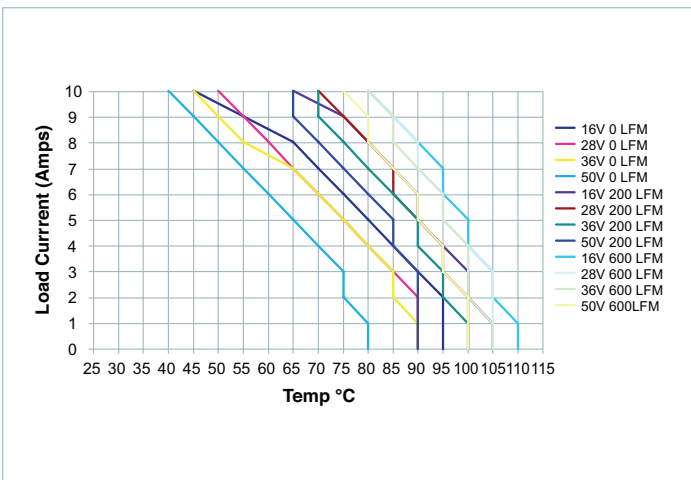

Figure 13 — Load current vs. temperature (6.33mm heat sink)

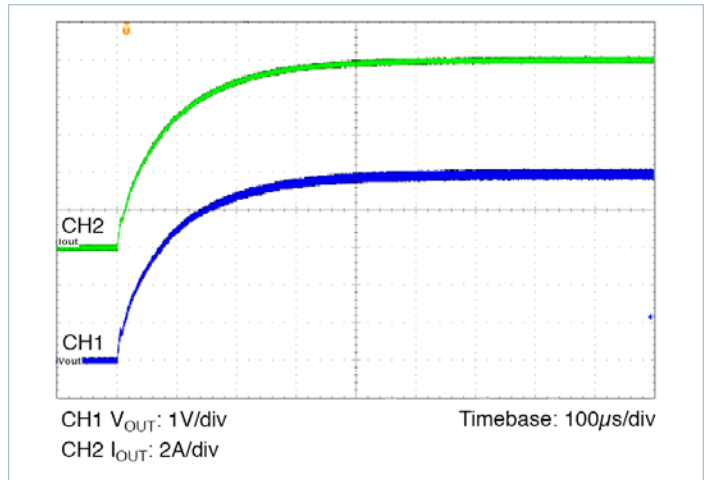

Figure 16 — Start up, $C_{REF} = 0$ ($V_{IN} = 28V$, $I_{OUT} = 10A$, CR, $C_{OUT} = 6 \times 10\mu F$ X7R ceramic)

PI3109-00-HVMZ Electrical Characteristics (Cont.)

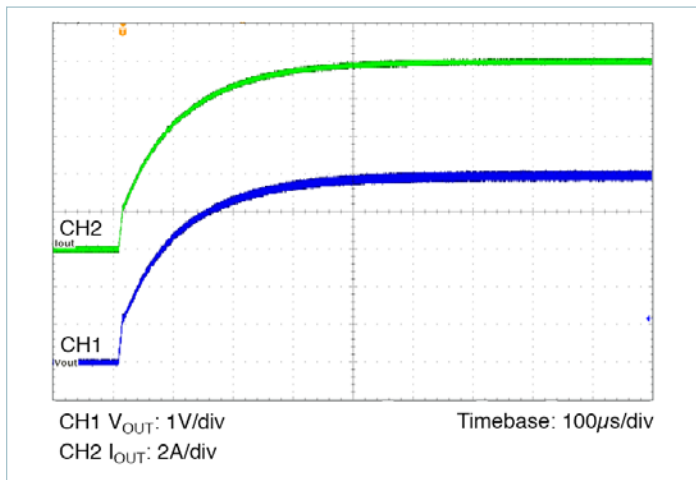

Figure 17 — Start up, $C_{REF} = 0$ ($V_{IN} = 50V$, $I_{OUT} = 10A$, CR, $C_{OUT} = 6 \times 10\mu F$ X7R ceramic)



Figure 20 — Thermal image ($V_{IN} = 28V$, $I_{OUT} = 10A$, CR, OLFM evaluation PCB)

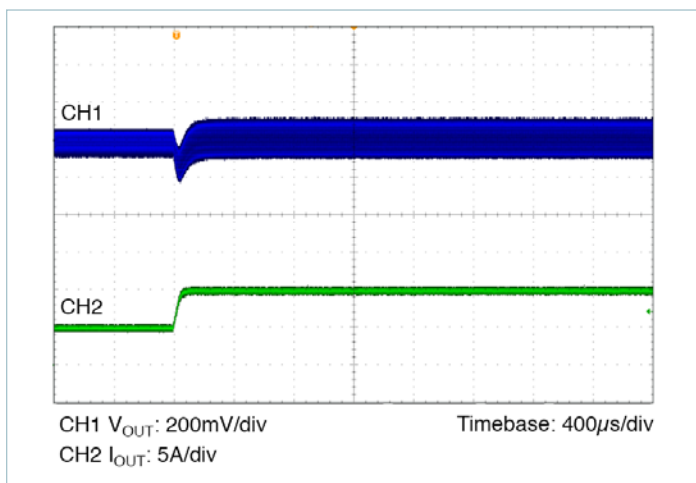

Figure 18 — Transient response ($V_{IN} = 28V$, $I_{OUT} = 5 - 10A$, $0.1A/\mu s$, $C_{OUT} = 6 \times 10\mu F$ X7R ceramic)

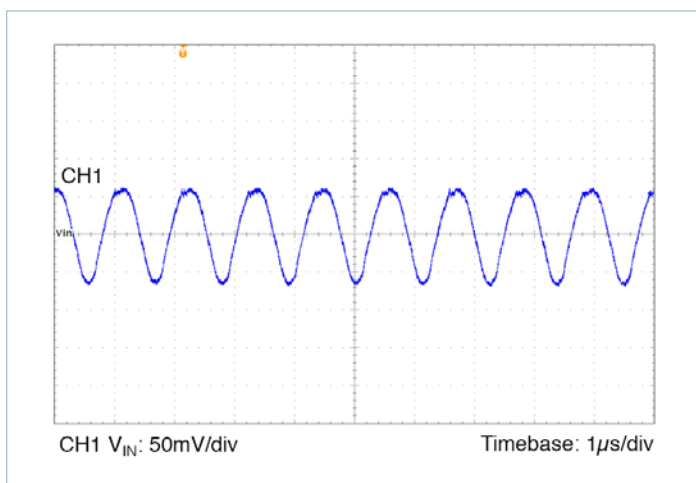

Figure 19 — Output ripple ($V_{IN} = 28V$, $I_{OUT} = 10A$, CR, $C_{OUT} = 6 \times 10\mu F$ X7R ceramic)

PI3106-00-HVMZ Electrical Characteristics

Unless otherwise specified: $16V < V_{IN} < 50V$, $0A < I_{OUT} < 4.2A$, $-55^{\circ}C < T_{CASE} < 100^{\circ}C$ [a]

| Parameter | Symbol | Conditions | Min | Typ | Max | Unit |
|--|----------------------|---|------|-------|------|-----------|
| Input Specifications | | | | | | |
| Input Voltage Range | V_{IN} | | 16 | 28 | 50 | V_{DC} |
| Input dV/dt [a] | V_{INDVDT} | $V_{IN} = 50V$ | | | 1.0 | $V/\mu s$ |
| Input Undervoltage Turn-on | V_{UVON} | $I_O = 4.2A$ | 14.5 | 15.4 | 16 | V_{DC} |
| Input Undervoltage Turn-off | V_{UVOFF} | $I_O = 4.2A$ | 13.5 | 14.4 | 15.2 | V_{DC} |
| Input Undervoltage Hysteresis | V_{UVH} | $I_O = 4.2A$ | | 1.0 | | V_{DC} |
| Input Overvoltage Turn-on | V_{OVON} | $I_O = 4.2A$ | 50 | 52.3 | 54 | V_{DC} |
| Input Overvoltage Turn-off | V_{OVOFF} | $I_O = 4.2A$ | 51 | 53.5 | 55 | V_{DC} |
| Input Overvoltage Hysteresis | V_{OVH} | $I_O = 4.2A$ | | 1.2 | | V_{DC} |
| Input Quiescent Current | I_Q | $V_{IN} = 28V$, $ENABLE = 0V$ | | 2 | | mA_{DC} |
| Input Idling Power | P_{IDLE} | $V_{IN} = 28V$, $I_{OUT} = 0A$ | | 3.5 | | W |
| Input Standby Power | P_{SBY} | $V_{IN} = 28V$, $ENABLE = 0V$ | | 0.056 | | W |
| Input Current Full Load | I_{IN} | $T_{CASE} = 100^{\circ}C$, $I_{OUT} = 4.2A$, $\eta_{FL} = 88\%$ typical, $V_{IN} = 28V$ | | 2.045 | | A_{DC} |
| Input Reflected Ripple Current | I_{INRR} | $L_{IN} = 0.47\mu H$ $C_{IN} = 100\mu F$ 63V electrolytic + 2 x 4.7 μF 50V X7R ceramic | | 13 | | mApp |
| Recommended Ext Input Capacitance | C_{IN} | $C_{IN} = 100\mu F$ 63V electrolytic + 2 x 4.7 μF 50V X7R ceramic $C_{IN} = C_{bulk} + C_{hf}$ | | 109.4 | | μF |
| Output Specifications | | | | | | |
| Output Voltage Set Point | V_{OUT} | $I_{OUT} = 2.1A$ | | 12.0 | | V_{DC} |
| Total Output Accuracy | V_{OA} | $-0^{\circ}C < T_{CASE} < 100^{\circ}C$ | -3 | | +3 | % |
| | | $-55^{\circ}C < T_{CASE} < 0^{\circ}C$ | -5 | | +3 | % |
| Output Voltage Trim Range | V_{OAdj} | | -20 | | 10 | % |
| Output Current Range | I_{OUT} | | | | 4.2 | A_{DC} |
| Overcurrent Protection | I_{OCP} | | 4.6 | 6.8 | 12 | A_{DC} |
| Efficiency – Full Load | η_{FL} | $T_{CASE} = 100^{\circ}C$, $V_{IN} = 28V$ | 86 | 88 | | % |
| Efficiency – Half Load | η_{HL} | $T_{CASE} = 100^{\circ}C$, $V_{IN} = 28V$ | 83 | 85 | | % |
| Output OVP Set Point | V_{OVP} | | 13.8 | 14.6 | 15.3 | V_{DC} |
| Output Ripple Voltage | V_{ORPP} | $C_{OUT} = 6 \times 2.2\mu F$ 16V X7R DC-20MHz | | 150 | | mVpp |
| Switching Frequency | f_{SW} | | | 900 | | kHz |
| Output Turn-on Delay Time | t_{ONDLY} | $V_{IN} = V_{UVON}$ to $ENABLE = 5V$; V_{IN} rise time < 1ms | | 80 | | ms |
| Output Turn-off Delay Time | t_{OFFDLY} | $V_{IN} = V_{UVOFF}$ to $ENABLE < 2.35V$ | | 375 | | μs |
| Soft-Start Ramp Time | t_{SS} | $ENABLE = 5V$ to 90% V_{OUT} $C_{REF} = 0$ | | 230 | | μs |
| Maximum Load Capacitance | C_{OUT} | $C_{REF} = 0.22\mu F$, $C_{OUT} = Al$ Electrolytic | | | 1000 | μF |
| Load Transient Deviation | V_{ODV} | $I_{OUT} = 50\%$ step 0.1A/ μs $C_{OUT} = 6 \times 2.2\mu F$ 16V X7R | | 360 | | mV |
| Load Transient Recovery Time | t_{OVR} | $I_{OUT} = 50\%$ step 0.1A/ μs $C_{OUT} = 6 \times 2.2\mu F$ 16V X7R $V_{OUT} \leq 1\%$ | | 100 | | μs |
| Maximum Output Power | P_{OUT} | | | 50 | | W |
| Absolute Maximum Output Ratings | | | | | | |
| Name | Rating | | | | | |
| +OUT to -OUT | -0.5V to 16 V_{DC} | | | | | |
| Continuous Output Current | 4.2 A_{DC} | | | | | |
| Peak Output Current | 12 A_{DC} | | | | | |

[a] These parameters are not production tested but are guaranteed by design, characterization and correlation with statistical process control.

Unless otherwise specified, ATE tests are completed at room temperature.

[b] Current flow sourced by a pin has a negative sign.

PI3106-00-HVMZ Electrical Characteristics (Cont.)

| Parameter | Symbol | Conditions | Min | Typ | Max | Unit |
|--|----------------|--|------|-------|------|------------------|
| ENABLE | | | | | | |
| DC Voltage Reference Output | V_{ERO} | | 4.65 | 4.9 | 5.15 | V_{DC} |
| Output Current Limit ^[b] | I_{ECL} | ENABLE = 3.3V | -3.3 | -2.6 | -1.9 | mA_{DC} |
| Start Up Current Limit ^[b] | I_{ESL} | ENABLE = 1V | -120 | -90 | -60 | μA |
| Module Enable Voltage | V_{EME} | | 1.95 | 2.5 | 3.05 | V_{DC} |
| Module Disable Voltage | V_{EMD} | | 1.8 | 2.35 | 2.9 | V_{DC} |
| Disable Hysteresis | V_{EDH} | | | 150 | | mV |
| Enable Delay Time | t_{EE} | | | 10 | | μs |
| Disable Delay Time | t_{ED} | | | 10 | | μs |
| Maximum Capacitance | C_{EC} | | | | 1500 | pF |
| Maximum External Toggle Rate | f_{EXT} | | | | 1 | Hz |
| TRIM/SS | | | | | | |
| Trim Voltage Reference | V_{REF} | | | 1.235 | | V_{DC} |
| Internal Capacitance | C_{REFI} | | | 10 | | nF |
| External Capacitance | C_{REF} | | | | 0.22 | μF |
| Internal Resistance | R_{REFI} | | | 10 | | k Ω |
| TM (Temperature Monitor) | | | | | | |
| Temperature Coefficient ^[a] | TM_{TC} | | | 10 | | mV / $^{\circ}K$ |
| Temperature Full Range Accuracy ^[a] | TM_{ACC} | | -5 | | 5 | $^{\circ}K$ |
| Drive Capability | I_{TM} | | -100 | | | μA |
| TM Output Setting | V_{TM} | Ambient Temperature = 300 $^{\circ}K$ | | 3.00 | | V |
| Thermal Specification | | | | | | |
| Junction Temperature Shutdown ^[a] | T_{MAX} | | 130 | 135 | 140 | $^{\circ}C$ |
| Junction-to-Case Thermal Impedance | θ_{J-C} | | | 3 | | $^{\circ}C / W$ |
| Case-to-Ambient Thermal Impedance | θ_{C-A} | Mounted on 9in ² 1oz. Cu 6 layer PCB 25 $^{\circ}C$ | | 8.2 | | $^{\circ}C / W$ |
| Soldering | | | | | | |
| Peak Temperature During Reflow | | MSL 5; time on floor = 48 hours | | | 225 | $^{\circ}C$ |
| | | MSL 6; time on floor = 4 hours | | | 245 | $^{\circ}C$ |
| Regulatory Specification | | | | | | |
| IEC 60950-1:2005 (2nd Edition) | | | | | | |
| EN 60950-1:2006 | | | | | | |
| IEC 61000-4-2 | | | | | | |
| UL60950-1:2007 | | | | | | |
| CAN/CSA C22.2 NO. 60950-1-07 | | | | | | |
| Recommended Input Fuse Rating | I_{FUSE} | Fast acting LITTLEFUSE Nano ² Series Fuse | 4 | | 10 | A |

^[a] These parameters are not production tested but are guaranteed by design, characterization and correlation with statistical process control. Unless otherwise specified, ATE tests are completed at room temperature.

^[b] Current flow sourced by a pin has a negative sign.

PI3106-00-HVMZ Electrical Characteristics (Cont.)

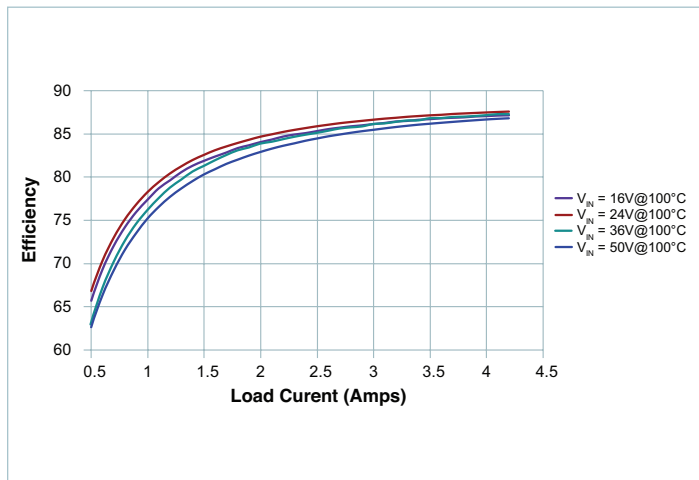

Figure 21 — Conversion efficiency

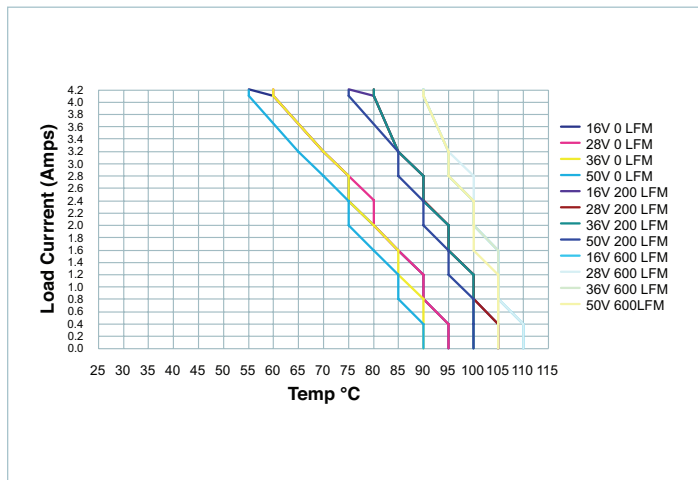

Figure 24 — Load current vs. temperature (11mm heat sink)

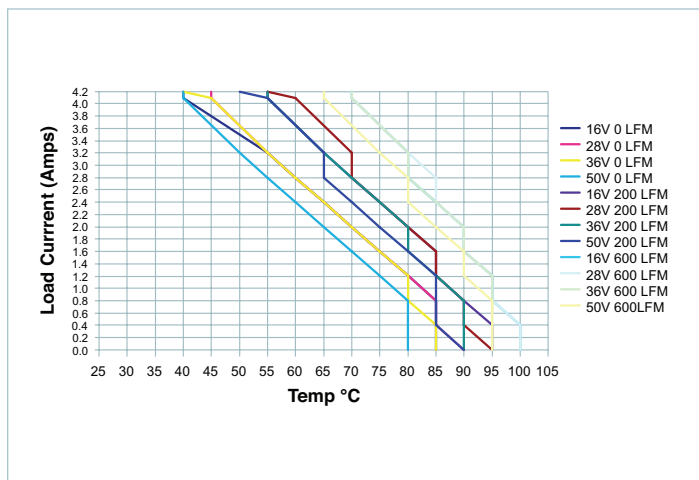

Figure 22 — Load current vs. temperature (without heat sink)

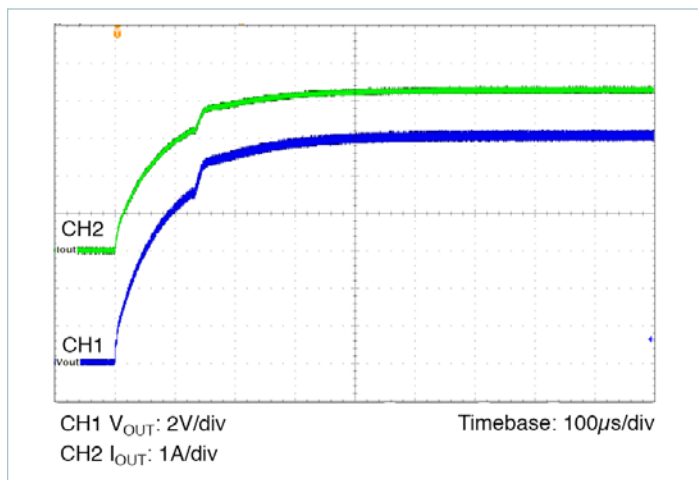

Figure 25 — Start up, $C_{REF} = 0$ ($V_{IN} = 16V$, $I_{OUT} = 4.2A$, C_R , $C_{OUT} = 6 \times 2.2\mu F$ X7R ceramic)

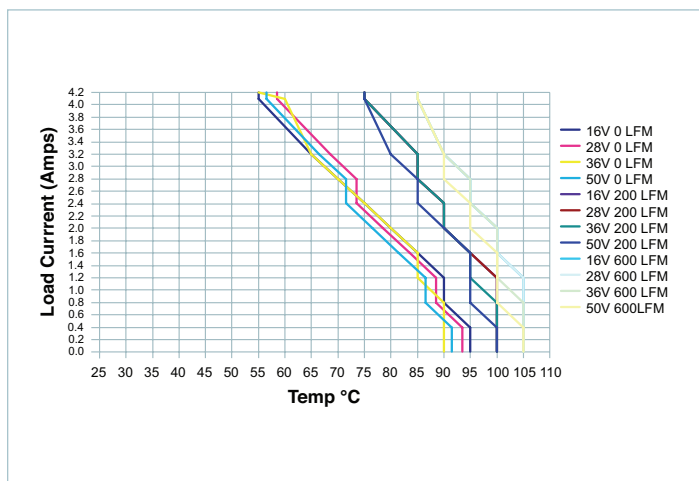

Figure 23 — Load current vs. temperature (6.3mm heat sink)

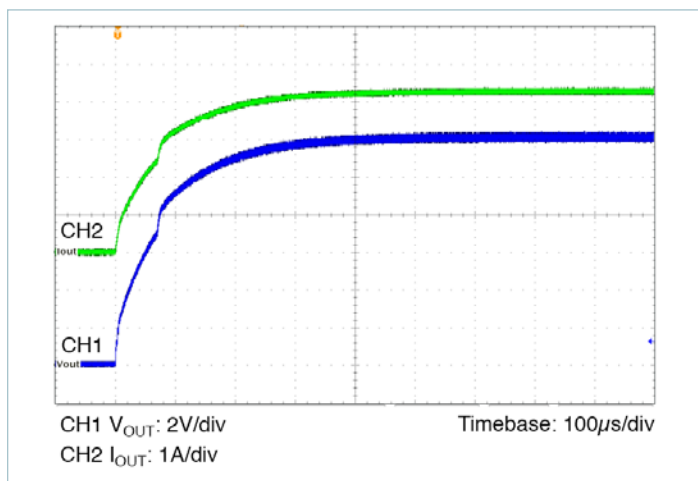

Figure 26 — Start up, $C_{REF} = 0$ ($V_{IN} = 28V$, $I_{OUT} = 4.2A$, C_R , $C_{OUT} = 6 \times 2.2\mu F$ X7R ceramic)

PI3106-00-HVMZ Electrical Characteristics (Cont.)

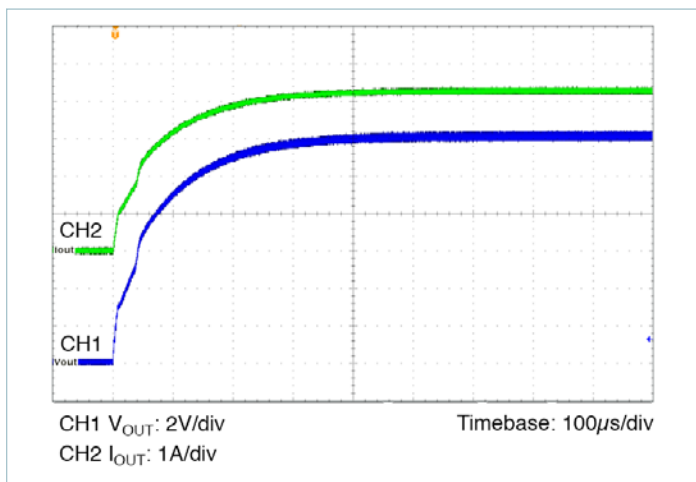

Figure 27 — Start up, $C_{REF} = 0$ ($V_{IN} = 50V$, $I_{OUT} = 4.2A$, $C_{OUT} = 6 \times 2.2\mu F$ X7R ceramic)



Figure 30 — Thermal image ($V_{IN} = 28V$, $I_{OUT} = 4.2A$, CR, OLFM evaluation PCB)

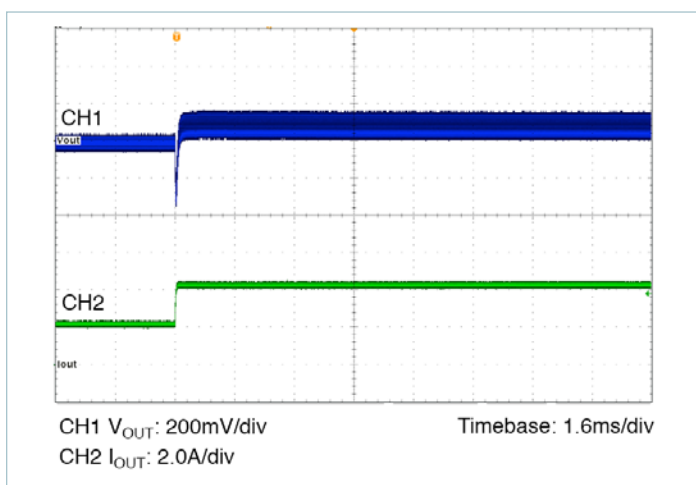

Figure 28 — Transient response ($V_{IN} = 28V$, $I_{OUT} = 2.1 - 4.2A$, $0.1A/\mu s$, $C_{OUT} = 6 \times 2.2\mu F$ X7R ceramic)

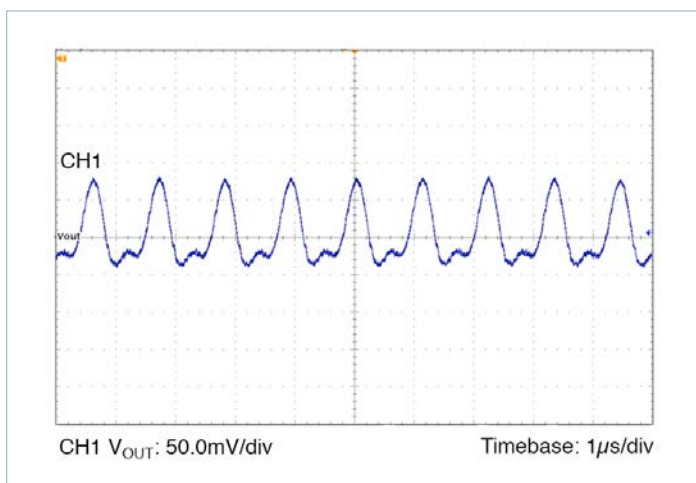

Figure 29 — Output ripple ($V_{IN} = 28V$, $I_{OUT} = 4.2A$, $C_{OUT} = 6 \times 2.2\mu F$ X7R ceramic)

PI3111-00-HVMZ Electrical Characteristics

Unless otherwise specified: $16V < V_{IN} < 50V$, $0A < I_{OUT} < 3.3A$, $-55^{\circ}C < T_{CASE} < 100^{\circ}C$ [a]

| Parameter | Symbol | Conditions | Min | Typ | Max | Unit |
|--|---------------------|---|------|-------|------|-----------|
| Input Specifications | | | | | | |
| Input Voltage Range | V_{IN} | | 16 | 28 | 50 | V_{DC} |
| Input dV/dt [a] | V_{INDVDT} | $V_{IN} = 50V$ | | | 1.0 | $V/\mu s$ |
| Input Undervoltage Turn-on | V_{UVON} | $I_O = 3.3A$ | 14.5 | 15.4 | 16 | V_{DC} |
| Input Undervoltage Turn-off | V_{UVOFF} | $I_O = 3.3A$ | 13.5 | 14.3 | 15.2 | V_{DC} |
| Input Undervoltage Hysteresis | V_{UVH} | $I_O = 3.3A$ | | 1.1 | | V_{DC} |
| Input Overvoltage Turn-on | V_{OVON} | $I_O = 3.3A$ | 50 | 52.4 | 54 | V_{DC} |
| Input Overvoltage Turn-off | V_{OVOFF} | $I_O = 3.3A$ | 51 | 53.5 | 55 | V_{DC} |
| Input Overvoltage Hysteresis | V_{OVH} | $I_O = 3.3A$ | | 1.1 | | V_{DC} |
| Input Quiescent Current | I_Q | $V_{IN} = 28V$, $ENABLE = 0V$ | | 2 | | mA_{DC} |
| Input Idling Power | P_{IDLE} | $V_{IN} = 28V$, $I_{OUT} = 0A$ | | 4.1 | | W |
| Input Standby Power | P_{SBY} | $V_{IN} = 28V$, $ENABLE = 0V$ | | 0.056 | | W |
| Input Current Full Load | I_{IN} | $T_{CASE} = 100^{\circ}C$, $I_{OUT} = 3.3A$, $\eta_{FL} = 87.5\%$ typical, $V_{IN} = 28V$ | | 2.039 | | A_{DC} |
| Input Reflected Ripple Current | I_{INRR} | $L_{IN} = 0.47\mu H$ $C_{IN} = 100\mu F$ 63V electrolytic + 2 x 4.7 μF 50V X7R ceramic | | 13 | | mApp |
| Recommended Ext Input Capacitance | C_{IN} | $C_{IN} = 100\mu F$ 63V electrolytic + 2 x 4.7 μF 50V X7R ceramic $C_{IN} = C_{bulk} + C_{hf}$ | | 109.4 | | μF |
| Output Specifications | | | | | | |
| Output Voltage Set Point | V_{OUT} | $I_{OUT} = 1.65A$ | | 15.0 | | V_{DC} |
| Total Output Accuracy | V_{OA} | $-0^{\circ}C < T_{CASE} < 100^{\circ}C$ | -3 | | +3 | % |
| | | $-55^{\circ}C < T_{CASE} < 0^{\circ}C$ | -5 | | +3 | % |
| Output Voltage Trim Range | V_{OAdj} | | -20 | | 10 | % |
| Output Current Range | I_{OUT} | | | | 3.3 | A_{DC} |
| Overcurrent Protection | I_{OCP} | | 3.8 | 5.6 | 9.6 | A_{DC} |
| Efficiency – Full Load | η_{FL} | $T_{CASE} = 100^{\circ}C$, $V_{IN} = 28V$ | 85.5 | 87.5 | | % |
| Efficiency – Half Load | η_{HL} | $T_{CASE} = 100^{\circ}C$, $V_{IN} = 28V$ | 82.3 | 84.3 | | % |
| Output OVP Set Point | V_{OVP} | | 17.6 | 18.2 | 18.8 | V_{DC} |
| Output Ripple Voltage | V_{ORPP} | $C_{OUT} = 6 \times 2.2\mu F$ 16V X7R DC-20MHz | | 275 | | mVpp |
| Switching Frequency | f_{SW} | | | 900 | | kHz |
| Output Turn-on Delay Time | t_{ONDLY} | $V_{IN} = V_{UVON}$ to $ENABLE = 5V$; V_{IN} rise time < 1ms | | 80 | | ms |
| Output Turn-off Delay Time | t_{OFFDLY} | $V_{IN} = V_{UVOFF}$ to $ENABLE < 2.35V$ | | 375 | | μs |
| Soft-Start Ramp Time | t_{SS} | $ENABLE = 5V$ to 90% V_{OUT} $C_{REF} = 0$ | | 230 | | μs |
| Maximum Load Capacitance | C_{OUT} | $C_{REF} = 0.22\mu F$, $C_{OUT} = Al$ Electrolytic | | | 1000 | μF |
| Load Transient Deviation | V_{ODV} | $I_{OUT} = 50\%$ step $0.1A/\mu s$ $C_{OUT} = 6 \times 2.2\mu F$ 16V X7R | | 375 | | mV |
| Load Transient Recovery Time | t_{OVR} | $I_{OUT} = 50\%$ step $0.1A/\mu s$ $C_{OUT} = 6 \times 2.2\mu F$ 16V X7R $V_{OUT} \leq 1\%$ | | 100 | | μs |
| Maximum Output Power | P_{OUT} | | | 50 | | W |
| Absolute Maximum Output Ratings | | | | | | |
| Name | Rating | | | | | |
| +OUT to -OUT | -0.5V to $20V_{DC}$ | | | | | |
| Continuous Output Current | $3.3A_{DC}$ | | | | | |
| Peak Output Current | $9.6A_{DC}$ | | | | | |

[a] These parameters are not production tested but are guaranteed by design, characterization and correlation with statistical process control. Unless otherwise specified, ATE tests are completed at room temperature.

[b] Current flow sourced by a pin has a negative sign.

PI3111-00-HVMZ Electrical Characteristics (Cont.)

| Parameter | Symbol | Conditions | Min | Typ | Max | Unit |
|--|----------------|---|------|-------|------|-----------------|
| ENABLE | | | | | | |
| DC Voltage Reference Output | V_{ERO} | | 4.65 | 4.9 | 5.15 | V_{DC} |
| Output Current Limit ^[b] | I_{ECL} | ENABLE = 3.3V | -3.3 | -2.6 | -1.9 | mA_{DC} |
| Start Up Current Limit ^[b] | I_{ESL} | ENABLE = 1V | -120 | -90 | -60 | μA |
| Module Enable Voltage | V_{EME} | | 1.95 | 2.5 | 3.05 | V_{DC} |
| Module Disable Voltage | V_{EMD} | | 1.8 | 2.35 | 2.9 | V_{DC} |
| Disable Hysteresis | V_{EDH} | | | 150 | | mV |
| Enable Delay Time | t_{EE} | | | 10 | | μs |
| Disable Delay Time | t_{ED} | | | 10 | | μs |
| Maximum Capacitance | C_{EC} | | | | 1500 | pF |
| Maximum External Toggle Rate | f_{EXT} | | | | 1 | Hz |
| TRIM/SS | | | | | | |
| Trim Voltage Reference | V_{REF} | | | 1.230 | | V_{DC} |
| Internal Capacitance | C_{REFI} | | | 10 | | nF |
| External Capacitance | C_{REF} | | | | 0.22 | μF |
| Internal Resistance | R_{REFI} | | | 10 | | $k\Omega$ |
| TM (Temperature Monitor) | | | | | | |
| Temperature Coefficient ^[a] | TM_{TC} | | | 10 | | $mV / ^\circ K$ |
| Temperature Full Range Accuracy ^[a] | TM_{ACC} | | -5 | | 5 | $^\circ K$ |
| Drive Capability | I_{TM} | | -100 | | | μA |
| TM Output Setting | V_{TM} | Ambient Temperature = 300 $^\circ K$ | | 3.00 | | V |
| Thermal Specification | | | | | | |
| Junction Temperature Shutdown ^[a] | T_{MAX} | | 130 | 135 | 140 | $^\circ C$ |
| Junction-to-Case Thermal Impedance | θ_{J-C} | | | 3 | | $^\circ C / W$ |
| Case-to-Ambient Thermal Impedance | θ_{C-A} | Mounted on 9in ² 1oz. Cu 6 layer PCB 25 $^\circ C$ | | 9.4 | | $^\circ C / W$ |
| Soldering | | | | | | |
| Peak Temperature During Reflow | | MSL 5; time on floor = 48 hours | | | 225 | $^\circ C$ |
| | | MSL 6; time on floor = 4 hours | | | 245 | $^\circ C$ |
| Regulatory Specification | | | | | | |
| IEC 60950-1:2005 (2nd Edition) | | | | | | |
| EN 60950-1:2006 | | | | | | |
| IEC 61000-4-2 | | | | | | |
| UL60950-1:2007 | | | | | | |
| CAN/CSA C22.2 NO. 60950-1-07 | | | | | | |
| Recommended Input Fuse Rating | I_{FUSE} | Fast acting LITTLEFUSE Nano ² Series Fuse | 4 | | 10 | A |

^[a] These parameters are not production tested but are guaranteed by design, characterization and correlation with statistical process control. Unless otherwise specified, ATE tests are completed at room temperature.

^[b] Current flow sourced by a pin has a negative sign.

PI3111-00-HVMZ Electrical Characteristics (Cont.)

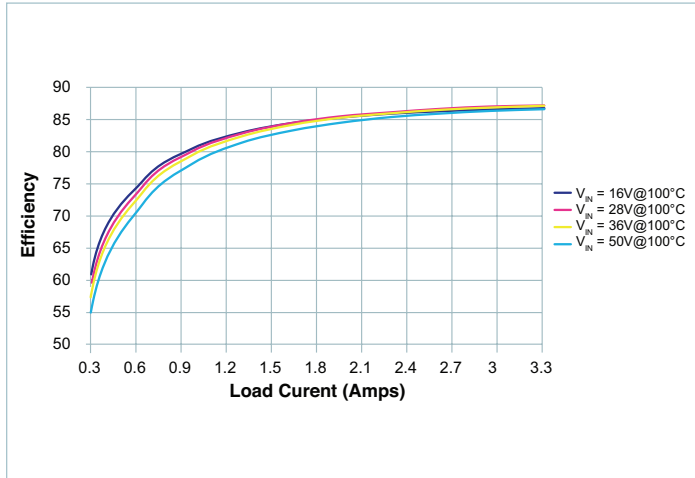

Figure 31 — Conversion efficiency

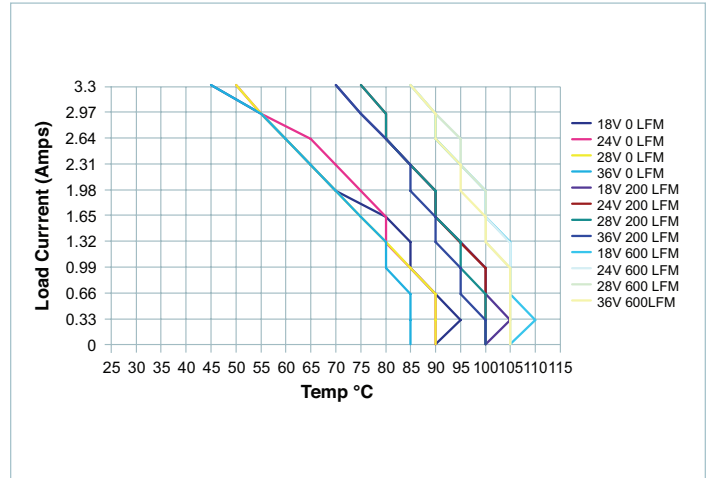

Figure 34 — Load current vs. temperature (11mm heat sink)

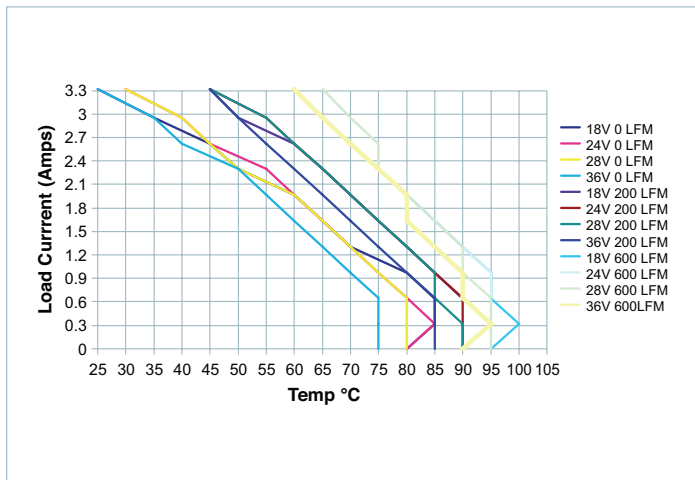

Figure 32 — Load current vs. temperature (without heat sink)

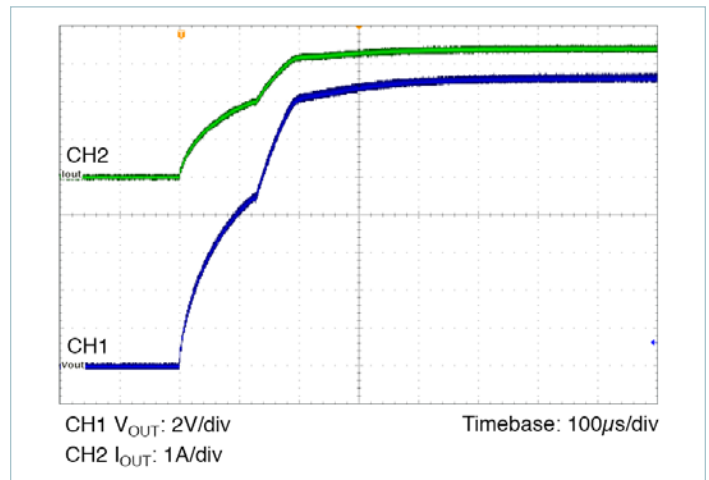

Figure 35 — Start up, $C_{REF} = 0$ ($V_{IN} = 16V$, $I_{OUT} = 3.3A$, C_R , $C_{OUT} = 6 \times 2.2\mu F$ X7R ceramic)

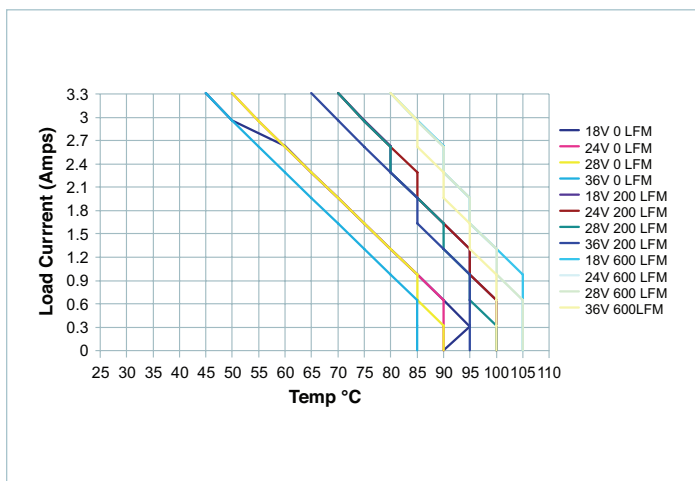

Figure 33 — Load current vs. temperature (6.33mm heat sink)

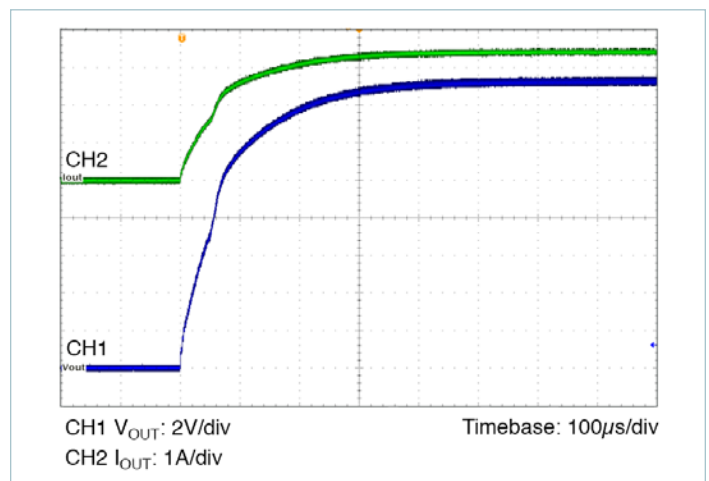

Figure 36 — Start up, $C_{REF} = 0$ ($V_{IN} = 28V$, $I_{OUT} = 3.3A$, C_R , $C_{OUT} = 6 \times 2.2\mu F$ X7R ceramic)

PI3111-00-HVMZ Electrical Characteristics (Cont.)

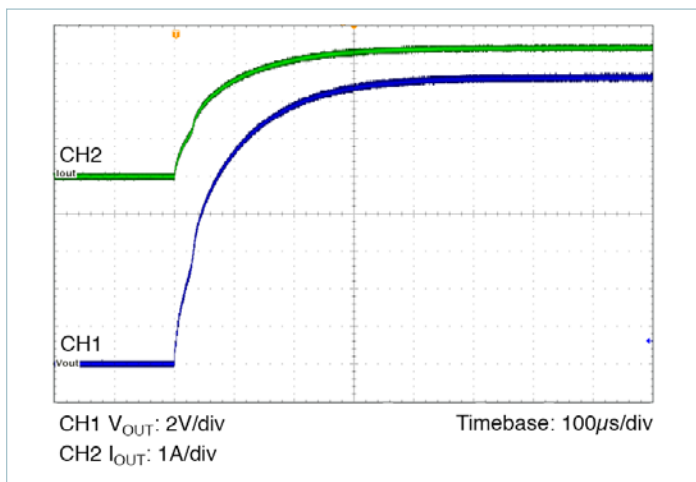

Figure 37 — Start up, $C_{REF} = 0$ ($V_{IN} = 50V$, $I_{OUT} = 3.3A$, CR, $C_{OUT} = 6 \times 2.2\mu F$ X7R ceramic)



Figure 40 — Thermal image ($V_{IN} = 28V$, $I_{OUT} = 3.33A$, CR, OLFM Evaluation PCB)

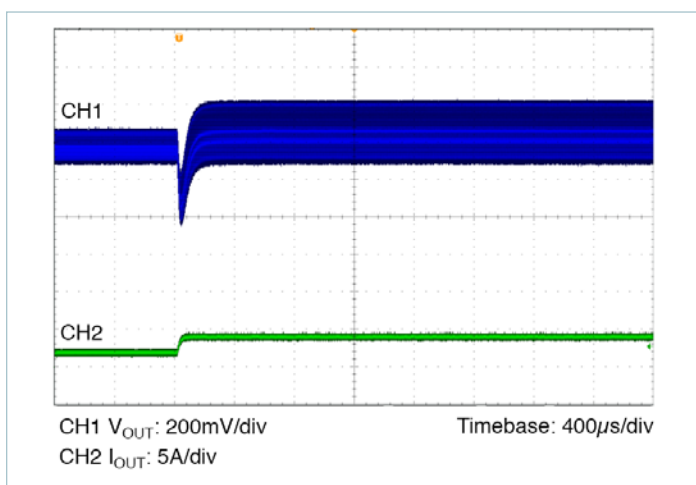

Figure 38 — Transient response ($V_{IN} = 28V$, $I_{OUT} = 1.65 - 3.3A$, $0.1A/\mu s$, $C_{OUT} = 6 \times 2.2\mu F$ X7R ceramic)

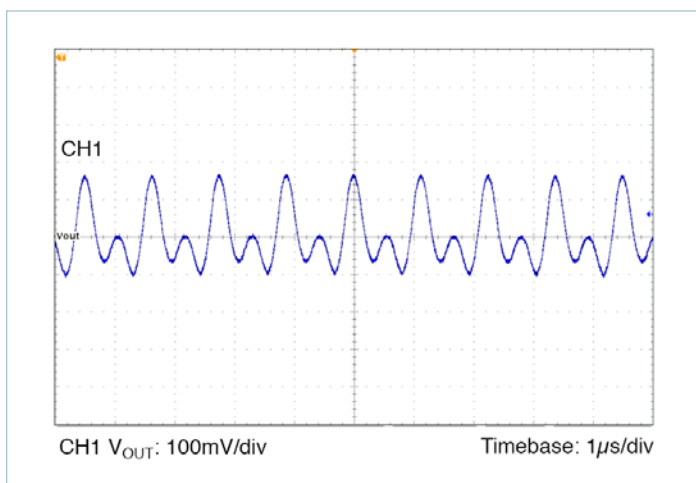

Figure 39 — Output ripple ($V_{IN} = 28V$, $I_{OUT} = 3.3A$, $C_{OUT} = 6 \times 2.2\mu F$ X7R ceramic)

Functional Description

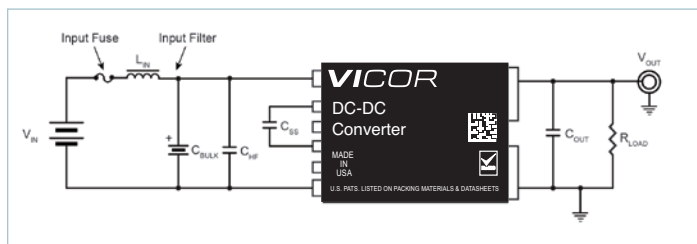

Figure 41 — PI31xx-00-HVMZ shown with system fuse, filter, decoupling and extended soft start

Input Power Pins IN(+) and IN(-)

The input power pins on the PI31xx-00-HVMZ are connected to the input power source which can range from 16 – 50V_{DC}. Under surge conditions, the PI31xx-00-HVMZ can withstand up to 55V_{DC} for 12.5ms without incurring damage. The user should take care to avoid driving the input rails above the specified ratings. Since the PI31xx-00-HVMZ is designed with high reliability in mind, the input pins are continuously monitored. If the applied voltage exceeds the input overvoltage trip point (typically 53.5V) the conversion process shall be terminated immediately. The converter initiates soft start automatically within 80ms after the input voltage is reduced back to the appropriate value. The input pins do not have reverse-polarity protection. If the PI31xx-00-HVMZ is operated in an environment where reverse polarity is a concern, the user should consider using a polarity protection device such as a suitably rated diode. To avoid the high losses of using a diode, the user should consider the much higher efficiency family of intelligent Cool-ORing[®] solutions that can be used in reverse-polarity applications. Information is available at vicorpower.com.

The PI31xx-00-HVMZ will draw nearly zero current until the input voltage reaches the internal start up threshold. If the ENABLE pin is not pulled low by external circuitry, the output voltage will begin rising to its final output value about 80ms after the input UV lockout releases. This will occur automatically even if the ENABLE pin is floating.

To help keep the source impedance low, the input to the PI31xx-00-HVMZ should be bypassed with (2) 4.7μF 50V ceramic capacitors of X7R dielectric in parallel with a low Q 100μF 63V electrolytic capacitor. To reduce EMI and reflected ripple current, a series inductor of 0.2 – 0.47μH can be added. The input traces to the module should be low impedance configured in such a manner as to keep stray inductance minimized.

ENABLE

The ENABLE pin serves as a multi-function pin for the PI31xx-00-HVMZ. During normal operation, it outputs the on-board 4.9V regulator which can be used for trimming the module up. The ENABLE pin can also be used as a remote enable pin either from the secondary via an optocoupler and an external isolated bias supply or from the primary side through a small-signal transistor, FET, or any device that sinks 3.3mA, minimum.

If the ENABLE pin is lower than 2.35V typical, the converter will be held off or shut down if already operating. A third feature is offered in that during a fault condition, such as output OVP, input UV or OV, or output current limit, the ENABLE pin is pulled low internally. This can be used as a signal to the user that a fault has occurred. Whenever the ENABLE pin is pulled low, the TRIM/SS pin follows, resetting the internal and external soft-start circuitry. All faults will pull ENABLE low including overtemperature. If increased turn-on delay is desired, the ENABLE pin can be bypassed with a small capacitor up to a maximum of 1500pF.

TRIM/SS Pin

The TRIM/SS pin serves as another multi-purpose pin. First, it is used as the reference for the internal error amplifier. Connecting a resistor from TRIM/SS to SGND allows the reference to be margined down by as much as –20%. Connecting a resistor from TRIM/SS to ENABLE will allow the reference and output voltage to be margined up by 10%. If the user wishes a longer start up time, a small ceramic capacitor can be added to TRIM/SS to increase it. It is critical to connect any device between TRIM/SS and SGND and not –IN, otherwise high frequency noise will be introduced to the reference and possibly cause erratic operation. Referring to the figures below, the appropriate trim up or trim-down resistor can be calculated using the equivalent circuit diagram and the equations. When trimming up, the trim-down resistor is not populated. When trimming down, the trim-up resistor is not populated. The soft-start time is adjustable and has a default value of 500μs to reach steady state. The internal soft-start capacitor value is 10nF.

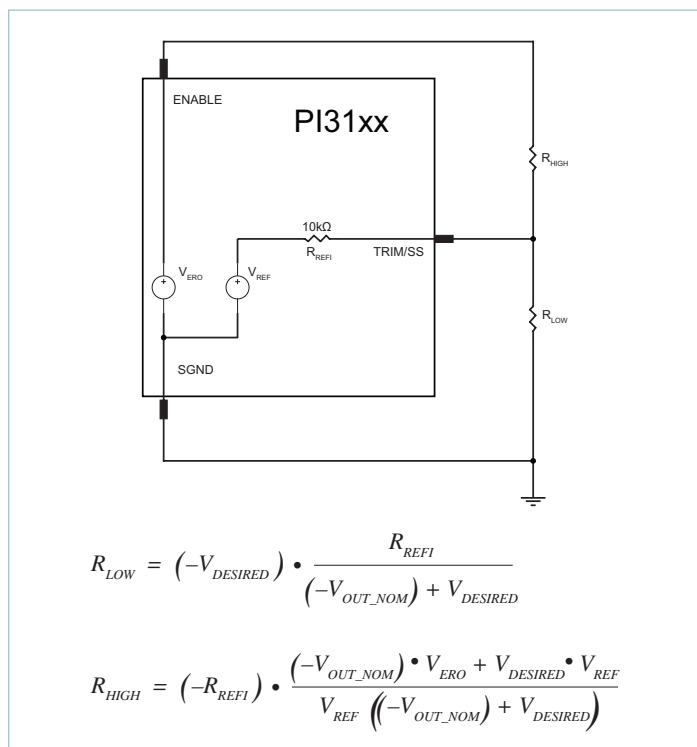

Figure 42 — Trim equations and equivalent circuit

$$C_{REF} = \frac{T_{SS_DESIRED} - 230 \cdot 10^{-6}}{23000}$$

TM

The TM pin serves as an output indicator of the internal package temperature which is within $\pm 5^{\circ}\text{K}$ of the hottest junction temperature. Because of this, it is a good indicator of a thermal overload condition. The output is a scaled, buffered analog voltage which indicates the internal temperature in degrees Kelvin. Upon a thermal overload, the TM pin is pulled low, indicating a thermal fault has occurred. Upon restart of the converter, the TM pin reverts back to a buffered monitor. The thermal shutdown function of the PI31xx-00-HVMZ is a fault feature which interrupts power processing if a certain maximum temperature is exceeded. TM can be monitored by an external microcontroller or circuit configured as an adaptive fan speed controller so that air flow in the system can be conveniently regulated.

SGND

The PI31xx-00-HVMZ SGND pin is the “quiet” control circuitry return. It is basically an extension of the internal signal ground. To avoid contamination and potential ground loops, this ground should NOT be connected to –IN since it is already star connected inside the package. Connect signal logic to SGND.

Output Power Pins +OUT and –OUT

The output power terminals OUT(+) and OUT(–) deliver the maximum output current from the PI31xx-00-HVMZ through the J-lead output pins. This configuration allows for a low impedance output and should be connected to multi-layer PCB parallel planes for best performance. Due to the high switching frequency, output ripple and noise can be easily attenuated by adding just a few high-quality X7R ceramic capacitors while retaining adequate transient response for most applications. The PI31xx-00-HVMZ does not require any feedback loop compensation nor does it require any opto-isolation. All isolation is contained within the package. This greatly simplifies the use of the converter and eliminates all outside influences of noise on the quality of the output voltage regulation and feedback loop. It is important for the user to minimize resistive connections from the load to the converter output and to keep stray inductance to a minimum for best regulation and transient response. The very small size footprint and height of the PI31xx-00-HVMZ allows the converter to be placed in the optimum location to allow for tight connections to the point-of-load.

Package Outline & Recommended PCB Land Pattern

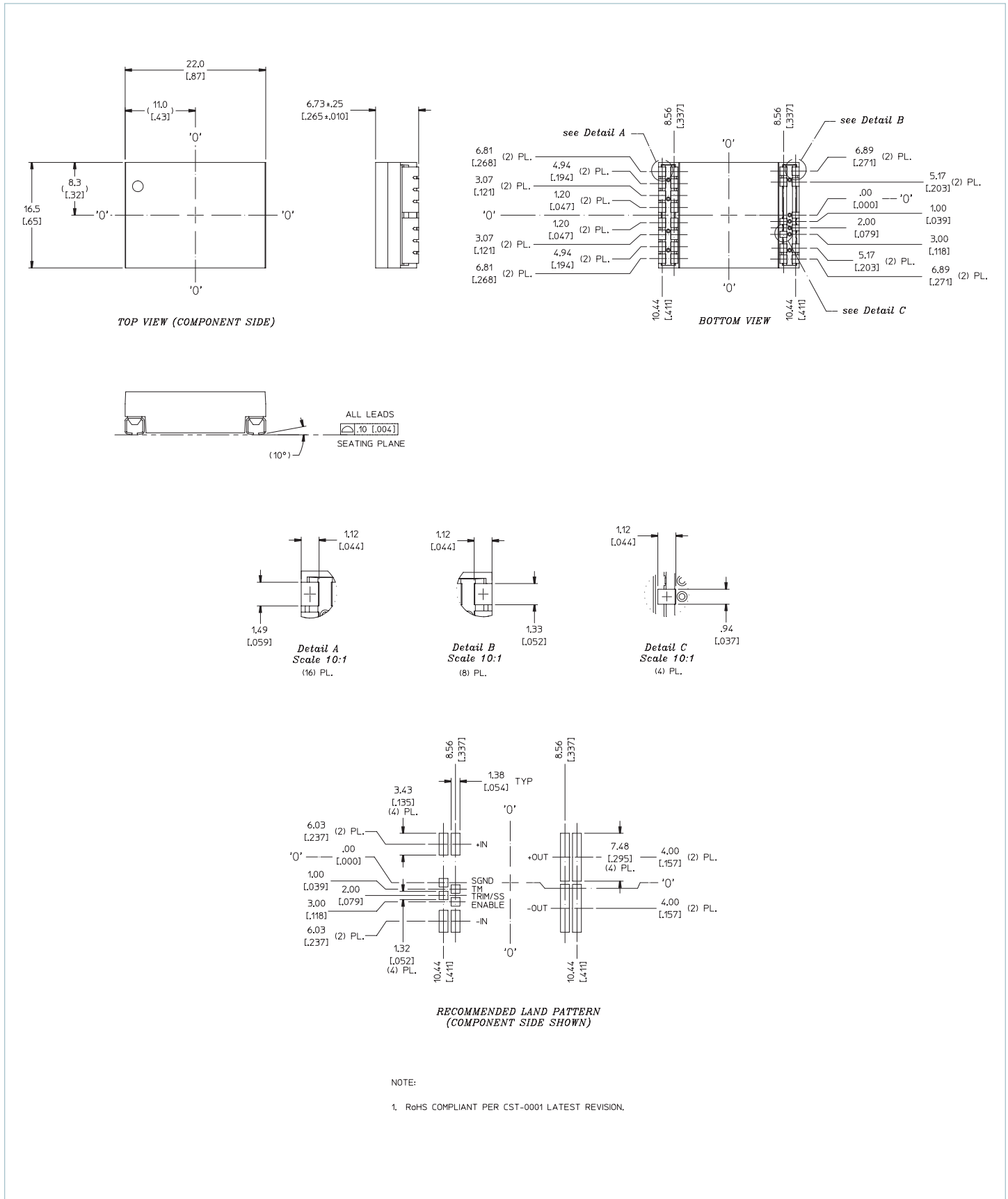

Figure 43 — Package outline & recommended PCB land pattern

Vicor's comprehensive line of power solutions includes high density AC-DC and DC-DC modules and accessory components, fully configurable AC-DC and DC-DC power supplies, and complete custom power systems.

Information furnished by Vicor is believed to be accurate and reliable. However, no responsibility is assumed by Vicor for its use. Vicor makes no representations or warranties with respect to the accuracy or completeness of the contents of this publication. Vicor reserves the right to make changes to any products, specifications, and product descriptions at any time without notice. Information published by Vicor has been checked and is believed to be accurate at the time it was printed; however, Vicor assumes no responsibility for inaccuracies. Testing and other quality controls are used to the extent Vicor deems necessary to support Vicor's product warranty. Except where mandated by government requirements, testing of all parameters of each product is not necessarily performed.

Specifications are subject to change without notice.

Visit <http://www.vicorpower.com/pi31xx-isolated-regulated-dc-dc-converter> for the latest product information.

Vicor's Standard Terms and Conditions and Product Warranty

All sales are subject to Vicor's Standard Terms and Conditions of Sale, and Product Warranty which are available on Vicor's webpage (<http://www.vicorpower.com/termsconditionswarranty>) or upon request.

Life Support Policy

VICOR'S PRODUCTS ARE NOT AUTHORIZED FOR USE AS CRITICAL COMPONENTS IN LIFE SUPPORT DEVICES OR SYSTEMS WITHOUT THE EXPRESS PRIOR WRITTEN APPROVAL OF THE CHIEF EXECUTIVE OFFICER AND GENERAL COUNSEL OF VICOR CORPORATION. As used herein, life support devices or systems are devices which (a) are intended for surgical implant into the body, or (b) support or sustain life and whose failure to perform when properly used in accordance with instructions for use provided in the labeling can be reasonably expected to result in a significant injury to the user. A critical component is any component in a life support device or system whose failure to perform can be reasonably expected to cause the failure of the life support device or system or to affect its safety or effectiveness. Per Vicor Terms and Conditions of Sale, the user of Vicor products and components in life support applications assumes all risks of such use and indemnifies Vicor against all liability and damages.

Intellectual Property Notice

Vicor and its subsidiaries own Intellectual Property (including issued U.S. and Foreign Patents and pending patent applications) relating to the products described in this data sheet. No license, whether express, implied, or arising by estoppel or otherwise, to any intellectual property rights is granted by this document. Interested parties should contact Vicor's Intellectual Property Department.

The products described on this data sheet are protected by U.S. Patents. Please see www.vicorpower.com/patents for the latest patent information.

Contact Us: <http://www.vicorpower.com/contact-us>

Vicor Corporation
25 Frontage Road
Andover, MA, USA 01810
Tel: 800-735-6200
Fax: 978-475-6715
www.vicorpower.com

email

Customer Service: custserv@vicorpower.com
Technical Support: apps@vicorpower.com

X-ON Electronics

Largest Supplier of Electrical and Electronic Components

Click to view similar products for [Isolated DC/DC Converters](#) category:

Click to view products by [Vicor](#) manufacturer:

Other Similar products are found below :

[ESM6D044440C05AAQ](#) [FMD15.24G](#) [PSL486-7LR](#) [Q48T30020-NBB0](#) [JAHW100Y1](#) [SPB05C-12](#) [SQ24S15033-PS0S](#) [18952](#) [19-130041](#)
[CE-1003](#) [CE-1004](#) [GQ2541-7R](#) [RDS180245](#) [MAU228](#) [J80-0041NL](#) [DFC15U48D15](#) [XGS-0512](#) [XGS-1205](#) [XGS-1212](#) [XGS-2412](#) [XGS-](#)
[2415](#) [XKS-1215](#) [06322](#) [NCT1000N040R050B](#) [SPB05B-15](#) [SPB05C-15](#) [L-DA20](#) [DCG40-5G](#) [QME48T40033-PGB0](#) [XKS-2415](#) [XKS-2412](#)
[XKS-1212](#) [XKS-1205](#) [XKS-0515](#) [XKS-0505](#) [XGS-2405](#) [XGS-1215](#) [XGS-0515](#) [PS9Z-6RM4](#) [73-551-5038I](#) [AK1601-9RT](#) [VI-N61-CM](#) [VI-](#)
[R5022-EXWW](#) [PSC128-7iR](#) [RPS8-350ATX-XE](#) [DAS1004812](#) [PQA30-D24-S24-DH](#) [VI-M5F-CQ](#) [VI-LN2-EW](#) [VI-PJW01-CZY](#)