



# VITA 62 Power Supply

## VIT028x3U600y000

### VITA 62 DC-DC Converter

#### Features & Benefits

- Open VPX – VITA 62
- 18 – 45V input voltage range
- 600W output power
- 3U Open VPX power supply
- Conduction cooled
- I<sup>2</sup>C™ monitoring and control
- Input voltage reverse-polarity protection
- Remote voltage sense: VS1, VS2, VS3
- Parallel operation capable with proprietary wireless current sharing
- Overcurrent, overvoltage and overtemperature protections
- IPC 610 class 3
- No aluminum electrolytic capacitors
- Enable, inhibit, system reset and power fail controls
- Accredited laboratory military standard compliance: <sup>[a]</sup>
  - MIL-STD-704F
  - MIL-STD-461G
  - MIL-STD-810G
  - MIL-STD-1275E
  - RTCA/DO-160G

#### Typical Applications

- VPX power modules
- Avionics
- Shipborne electronics

#### Product Description

The Vicor VITA 62 power supply is a COTs power supply that is designed for 3U Open VPX systems. The module utilizes Vicor proprietary technology to enable high efficiency and power density for this highly rugged, conduction-cooled model.

Up to four power supplies can be paralleled to increase output power capability of VS1, VS2, VS3 outputs with proprietary wireless current sharing. Conventional current-share pins are eliminated. Current share accuracy is  $\pm 2A$ .

<sup>[a]</sup> See detailed specifications; contact Vicor Applications Engineering for report details.

Note: Product images may not highlight current product markings.

Connector Pin Configuration

ROWS	POWER			SIGNAL								POWER					
				1	2	3	4	5	6	7	8						
D	P1	P2	LP1										P3	P4	P5	LP2	P6
C																	
B																	
A																	

**3U P0 Connector**

Note: See mechanical drawing on page 30 for connector information.

## Connector Pin Descriptions

Pin	Function / Name	Description
P1	-DC_IN	V <sub>IN-</sub>
P2	+DC_IN	V <sub>IN+</sub>
LP1	CHASSIS	Chassis
A1	No Connection	
B1	No Connection	
C1	No Connection	
D1	No Connection	
A2	No Connection	
B2	FAIL*	When any of the output is not within specification, FAIL* signal will be driven low to indicate a failure
C2	INHIBIT*	Input control signal as defined in VITA 62, referenced to SIGNAL_RETURN
D2	ENABLE*	Input control signal as defined in VITA 62, referenced to SIGNAL_RETURN
A3	No Connection	
B3	VAUX3	+12V auxiliary output voltage
C3	No Connection	
D3	No Connection	
A4, B4, C4, D4	VAUX2	+3.3V auxiliary output voltage
A5	*GA0	Geographical address defined by VITA 46.11
B5	*GA1	Geographical address defined by VITA 46.11
C5	SM0 (I <sup>2</sup> C Clock)	Primary I <sup>2</sup> C™ communication bus
D5	SM1 (I <sup>2</sup> C Data)	
A6	I <sup>2</sup> C Clock	Redundant I <sup>2</sup> C communication bus
B6	I <sup>2</sup> C Data	
C6	VAUX1	-12V auxiliary output voltage
D6	SYS_RESET*	System Reset is actively low. It will float when all outputs are within specification
A7	No Connection	
B7	No Connection	
C7	No Connection	
D7	SIGNAL_RETURN	Ground pin for control signals
A8	+12V <sub>SENSE</sub>	VS1 sense, should be connected at point-of-load or on the backplane to corresponding voltage output
B8	+3.3V <sub>SENSE</sub>	VS2 sense, should be connected at point-of-load or on the backplane to corresponding voltage output
C8	+5V <sub>SENSE</sub>	VS3 sense, should be connected at point-of-load or on the backplane to corresponding voltage output
D8	SENSE_RETURN	Should be connected to POWER_RETURN either remotely or at the connector
P3	VS3	+5V main output
P4, P5	POWER_RETURN	Common output voltage return pin
LP2	VS2	+3.3V main output
P6	VS1	+12V main output

## Part Ordering Information

Part Number	Product Grade	Conformal Coating	Factory-Configured Options
VIT028H3U600C000	H = -40 to 85°C	C = Coated	000 = Programmable <sup>[b]</sup>
VIT028H3U600D000		D = Coated + AU-plated Connector	

<sup>[b]</sup> Factory option 000 units can be set by the user to parallel ready or standalone operation only via I<sup>2</sup>C™.

See I<sup>2</sup>C user guide for information on changing the unit from Parallel operation to Standalone. By default, units are set to parallel from the factory.

## Absolute Maximum Ratings

The absolute maximum ratings below are stress ratings only. Operation at or beyond these maximum ratings can cause permanent damage to the device.

Parameter	Comments	Min	Max	Unit
Total Output Power	Combined outputs for all rails		600	W
Operational Input Voltage	+IN to -IN, 100V 50ms operation MIL-STD-1275E surge only	-0.5	100	V
Operating Temperature	Measured at card edge	-40	85	°C
Storage Temperature		-55	125	
Isolation Voltage IN to OUT			500	V <sub>DC</sub>
Isolation Voltage IN to CASE			500	V <sub>DC</sub>
Isolation Voltage OUT to CASE			100	V

## Electrical Characteristics

All data at nominal line and nominal load unless otherwise specified.

Attribute	Symbol	Conditions / Notes	Min	Typ	Max	Unit
<b>Overall System Characteristics</b>						
System Efficiency		Nominal line, 25% aggregate loads		83		%
		Nominal line, 50% aggregate loads		87.0		
		Nominal line, 100% aggregate loads		87.5		
<b>Power Input Characteristics</b>						
Operating Input Voltage Range	$V_{IN}$		18	28	45	V
Input Current (No Load)	$I_{IN-NL}$	28V Input, enable asserted, inhibit de-asserted		0.50	0.60	A
Inrush Current	$I_{INRUSH}$	Peak no load, nominal line, high line; see Figure 5		70	120	A
Power On to +3.3V <sub>AUX</sub> Output Delay		If ENABLE* is tied to signal ground	100	150	200	ms
Input Undervoltage Lockout Recovery			16.8		17.8	V
<b>Power Output Characteristics</b>						
Output Power Limit (During Starting Disturbance)		Initial engagement surge, 12 – 16V, 1s per MIL-STD-1275E, see Figure 31			300	W
		Cranking surge, 16 – 18V, 30s per MIL-STD-1275E, see Figure 31	300		600	
<b>Main Outputs</b>						
<b>V51: +12V Output</b>						
Output Voltage Set Point			11.85	12.1	12.15	V
Output Regulation Over Line & Load				170	200	mV
Output Voltage Ripple / Noise		Nominal line from 2A load to full load		50	120	mV <sub>p-p</sub>
Rated Output Current	$I_{R-V51}$				40	A
Maximum Operating Transmission Voltage Drop	$V_{TD-V51}$				0.5	V
Maximum Output Capacitance	$C_{O-V51}$				9	mF
Soft-Start Ramp Time	$t_{SS-V51}$	All full load with max $C_{O-V51}$	5			ms

## Electrical Characteristics (Cont.)

All data at nominal line and nominal load unless otherwise specified.

Attribute	Symbol	Conditions / Notes	Min	Typ	Max	Unit
<b>Main Outputs (Cont.)</b>						
<b>VS3: +5V Output</b>						
Output Voltage Set Point			4.9	5.05	5.1	V
Output Regulation Over Line & Load				100	150	mV
Output Voltage Ripple / Noise		Nominal line over load range, 20MHz BW; measured with 1 $\mu$ F and 10 $\mu$ F ceramic capacitor		25	50	mV <sub>P-P</sub>
Rated Output Current	$I_{R-VS3}$				30	A
Maximum Operating Transmission Voltage Drop	$V_{TD-VS3}$				0.5	V
Maximum Output Capacitance	$C_{O-VS3}$				9	mF
Soft-Start Ramp Time	$t_{SS-VS3}$	All full load with max $C_{O-VS3}$	5			ms
<b>VS2: +3.3V Output</b>						
Output Voltage Set Point			3.25	3.4	3.45	V
Output Regulation Over Line & Load				100	150	mV
Output Voltage Ripple / Noise		Nominal line over load range, 20MHz BW; measured with 1 $\mu$ F and 10 $\mu$ F ceramic capacitor		10	50	mV <sub>P-P</sub>
Rated Output Current	$I_{R-VS2}$				20	A
Maximum Operating Transmission Voltage Drop	$V_{TD-VS2}$				0.3	V
Maximum Output Capacitance	$C_{O-VS2}$				9	mF
Soft-Start Ramp Time	$t_{SS-VS2}$	All full load with max $C_{O-VS2}$			50	ms

## Electrical Characteristics (Cont.)

All data at nominal line and nominal load unless otherwise specified.

Attribute	Symbol	Conditions / Notes	Min	Typ	Max	Unit
<b>Auxiliary Outputs</b>						
<b>VAUX1: -12V Output</b>						
Output Voltage Set Point			11.8	12.2	12.3	V
Output Regulation Over Line & Load					200	mV
Output Voltage Ripple / Noise		Nominal line over load range, 20MHz BW; measured with 1 $\mu$ F and 10 $\mu$ F ceramic capacitor		20	120	mV <sub>p-p</sub>
Rated Output Current	I <sub>R-VAUX1</sub>				1	A
Maximum Output Capacitance	C <sub>O-VAUX1</sub>				2	mF
Soft-Start Ramp Time	t <sub>SS-VAUX1</sub>	All full load with max C <sub>O-VAUX1</sub>			50	ms
<b>VAUX3: +12V Output</b>						
Output Voltage Set Point			11.5	12	12.6	V
Output Regulation Over Line & Load					1	V
Output Voltage Ripple / Noise		Output derived directly from VS1,+12V Main Output; output ripple and noise depends on VS1 load		40	180	mV <sub>p-p</sub>
Rated Output Current	I <sub>R-VAUX3</sub>				1	A
Maximum Output Capacitance	C <sub>O-VAUX3</sub>				2	mF
Soft-Start Ramp Time	t <sub>SS-VAUX3</sub>	All full load with max C <sub>O-VAUX3</sub>			5	ms
<b>VAUX2: +3.3V Output</b>						
Output Voltage Set Point			3.25	3.35	3.42	V
Output Regulation Over Line & Load				100	150	mV
Output Voltage Ripple / Noise		Nominal line over load range, 20MHz BW; measured with 1 $\mu$ F and 10 $\mu$ F ceramic capacitor		10	50	mV <sub>p-p</sub>
Rated Output Current	I <sub>R-VAUX2</sub>				6	A
Maximum Output Capacitance	C <sub>O-VAUX2</sub>				5	mF
Soft-Start Ramp Time	t <sub>SS-VAUX2</sub>	All full load with max C <sub>O-VAUX2</sub>			5	ms

## Signal Characteristics

All of the following plots are at nominal line and 600W aggregate load unless otherwise noted.

ENABLE*: Enable*								
<ul style="list-style-type: none"> <li>The ENABLE* pin or control register bit enables and disables the +3.3V AUX output of the power supply.</li> <li>The ENABLE* pin has an internal pull-up to V<sub>CC</sub> and is referenced to the Signal Return pin of the power supply.</li> </ul>								
Signal Type	State	Attribute	Symbol	Conditions / Notes	Min	Typ	Max	Unit
Digital Input	Any	ENABLE* Enable Threshold	V <sub>ENABLE-EN</sub>				0.8	V
		ENABLE* Disable Threshold	V <sub>ENABLE-DIS</sub>		2.0			V
		Internally Generated V <sub>CC</sub>	V <sub>CC</sub>		3.21	3.30	3.39	V
		ENABLE* Internal Pull-Up Resistance to V <sub>CC</sub>	R <sub>ENABLE-INT</sub>		49	51	52	kΩ
		ENABLE* Enable Debounce Delay	t <sub>D-EN-E</sub>		3	5		ms
		ENABLE* Disable Debounce Delay	t <sub>D-EN-D</sub>		3	5		ms

INHIBIT*: Inhibit*								
<ul style="list-style-type: none"> <li>The INHIBIT* pin enables and disables all outputs except +3.3V<sub>AUX</sub> if V<sub>ENABLE-EN</sub> threshold has been met.</li> <li>The INHIBIT* pin has an internal pull up to V<sub>CC</sub> and is referenced to the Signal Return pin of the power supply.</li> </ul>								
Signal Type	State	Attribute	Symbol	Conditions / Notes	Min	Typ	Max	Unit
Digital Input	Any	INHIBIT* Enable Threshold	V <sub>INHIBIT-EN</sub>	Status register bit 4 should be 0 (default) for digital input control line to have priority	2.0			V
		INHIBIT* Disable Threshold	V <sub>INHIBIT-DIS</sub>				0.8	V
		Internally Generated V <sub>CC</sub>	V <sub>CC</sub>		3.21	3.30	3.39	V
		INHIBIT* Internal Pull-Up Resistance to V <sub>CC</sub>	R <sub>DISABLE-INT</sub>		49	51	52	kΩ
		INHIBIT* Enable Debounce Delay after ENABLE*	t <sub>D-IN-E</sub>		3	5		ms
		INHIBIT* Disable Debounce Delay	t <sub>D-IN-D</sub>		3	5		ms
		Lockout Delay Between Consecutive INHIBIT* Enables	t <sub>D-IN-L</sub>		3	5		ms



## Signal Characteristics (Cont.)

All of the following plots are at nominal line and 600W aggregate load unless otherwise noted.

GA0*, GA1*: Geographical Address								
<ul style="list-style-type: none"> <li>The GA0* and GA1* pins sets the I<sup>2</sup>C™ address of the power supply. Geographical address is set at start up and cannot be changed without a power cycle.</li> <li>The GA0* and GA1* pins have an internal pull-up to V<sub>CC</sub> and is referenced to the Signal Return pin of the power supply.</li> </ul>								
Signal Type	State	Attribute	Symbol	Conditions / Notes	Min	Typ	Max	Unit
Digital Input	Start Up	Address Pins Low Threshold	V <sub>ADDR-L</sub>				0.8	V
		Address Pins High Threshold	V <sub>ADDR-H</sub>		2.0			V
		Internally Generated V <sub>CC</sub>	V <sub>CC</sub>		3.21	3.30	3.39	V
		ENABLE* Internal Pull-Up Resistance to V <sub>CC</sub>	R <sub>ADDR-INT</sub>		49	51	52	kΩ
		Address Pins Debounce Delay	t <sub>D-ADDR</sub>		5			ms

FAIL*, SYSRESET* & LED								
<ul style="list-style-type: none"> <li>The power supply has one two color LED located on the ejector edge of the power supply.</li> <li>The LED is either GREEN or RED depending on the state of operation. FAIL* and SYSRESET* lines are set with the LED.</li> </ul>								
Signal Type	State	Attribute	Symbol	Conditions / Notes	Min	Typ	Max	Unit
Outputs	Steady RED	SYSRESET*	V <sub>SYSRST</sub>	Start up: input voltage operating threshold V <sub>UV-IN</sub> < V <sub>IN</sub> < V <sub>OV-IN</sub> has been met; if steady RED persists for >100ms, a critical system fault has been detected during start up	0.0		0.8	V
		FAIL*	V <sub>FAIL</sub>		0.0		0.8	V
	Blinking GREEN	SYSRESET*	V <sub>SYSRST</sub>	>100ms after V <sub>UV-IN</sub> < V <sub>IN</sub> < V <sub>OV-IN</sub> has been met; power supply is ready for use	2.0		3.5	V
		FAIL*	V <sub>FAIL</sub>		2.0		3.5	V
	Steady GREEN	SYSRESET*	V <sub>SYSRST</sub>	All outputs are OK and ENABLE* is pulled low	2.0		3.5	V
		FAIL*	V <sub>FAIL</sub>		2.0		3.5	V
	Blinking RED	SYSRESET*	V <sub>SYSRST</sub>	Power supply has encountered a OT, OV, UV, OC or critical system failure during operating	2.0		3.5	V
		FAIL*	V <sub>FAIL</sub>		0.0		0.8	V
	Fast Blinking GREEN	None	-	SW priority is set by 0x55 status command	-	-	-	-
	Blinking Alternate GREEN/RED	None	-	Battle Override mode is enabled successfully by 0x55 status command	-	-	-	-

## Application Characteristics

All of the following plots are at nominal line and 600W aggregate load unless otherwise noted.

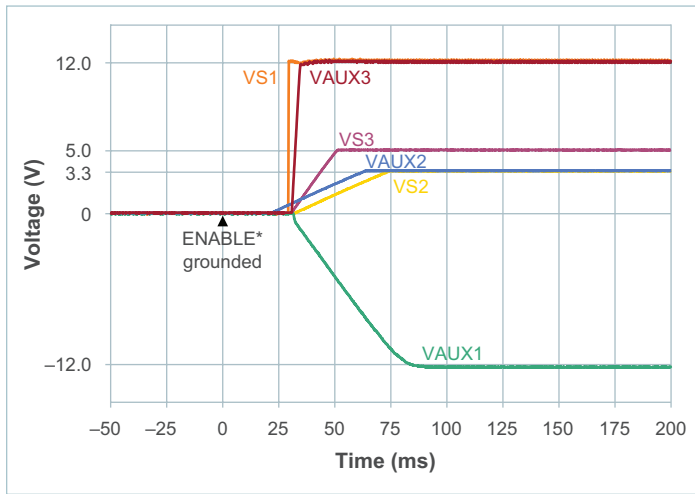

**Figure 1** — Response time from ENABLE\* pin grounded to outputs available; under 200ms start; 28V<sub>IN</sub>, INHIBIT\* floating, ENABLE\* grounded, no load

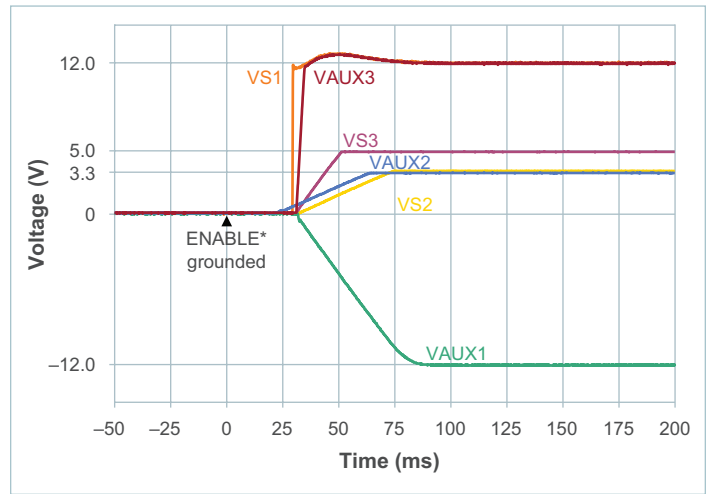

**Figure 2** — Response time from ENABLE\* pin grounded to outputs available; under 200ms start; 28V<sub>IN</sub>, INHIBIT\* floating, ENABLE\* grounded, full load

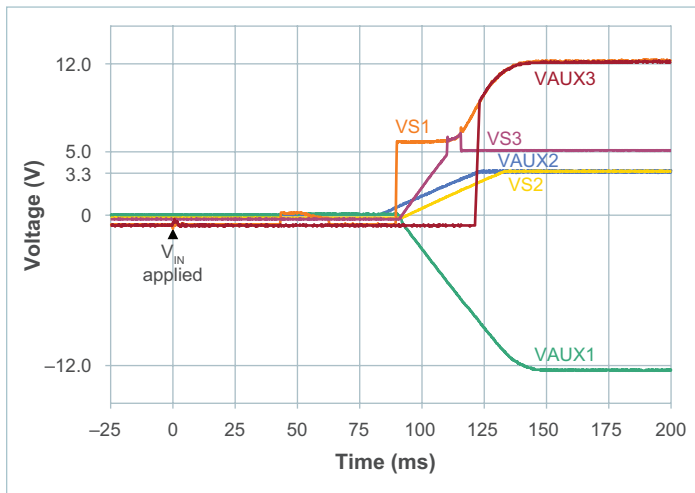

**Figure 3** — Response time from V<sub>IN</sub> applied to outputs available; under 200ms start; 28V<sub>IN</sub>, INHIBIT\* floating, ENABLE\* grounded, no load

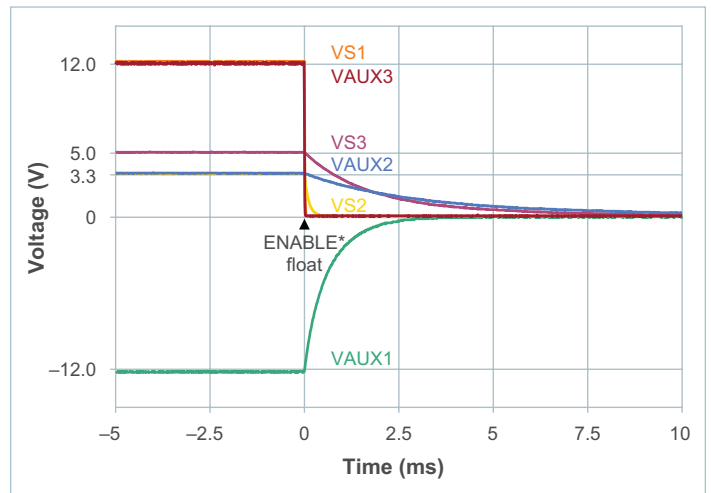

**Figure 4** — Discharge time of all outputs from ENABLE\* pin moving from ground to floating

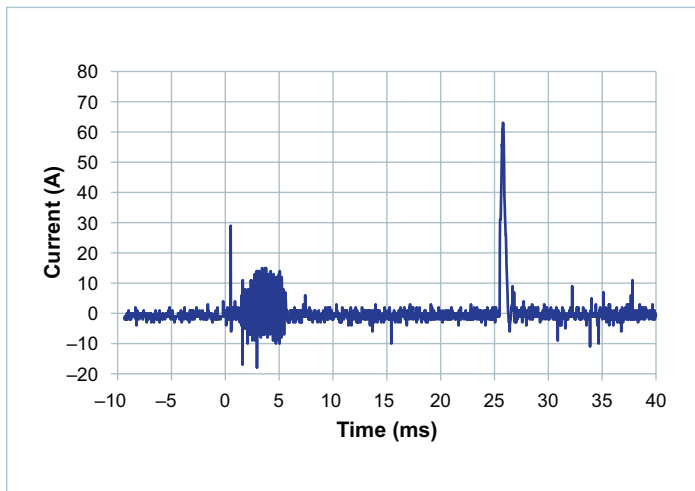

**Figure 5** — Measured inrush current at 28V input voltage

Application Characteristics (Cont.)

All of the following plots are at nominal line and 600W aggregate load unless otherwise noted.

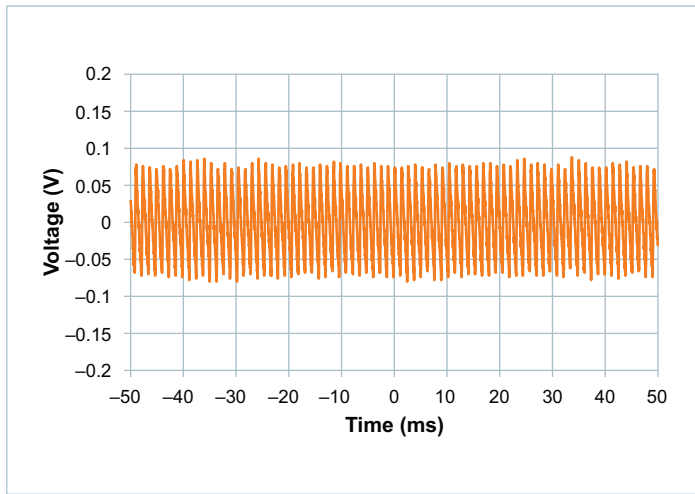

Figure 6 — VS1 (+12V) ripple with no load, AC-coupled

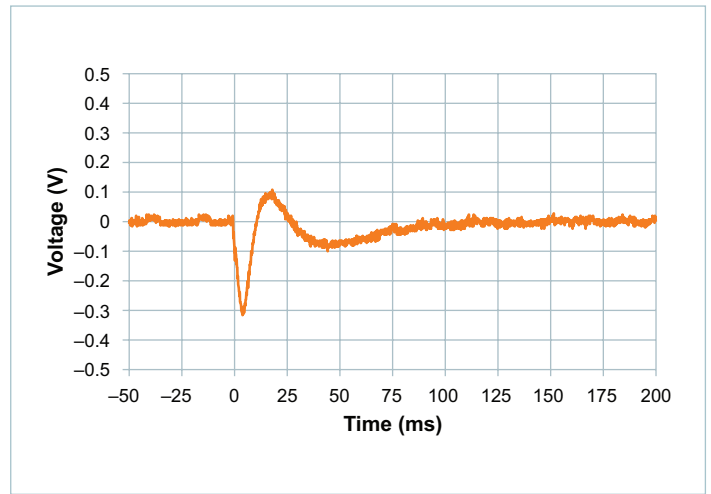

Figure 7 — Transient response of VS1 +12V output, load step from 1A to 40A; AC-coupled

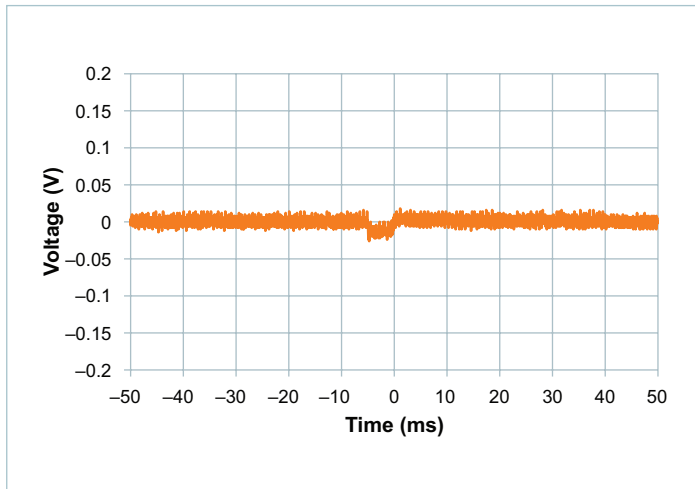

Figure 8 — VS1 (+12V) ripple with 1A load, AC-coupled

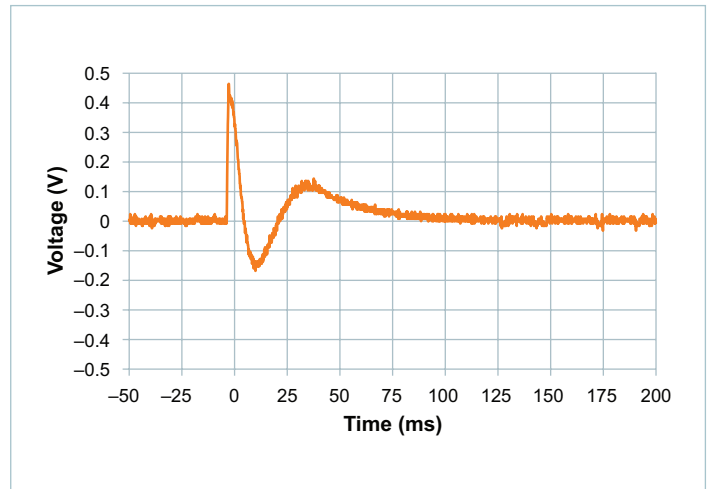

Figure 9 — Transient response of VS1 +12V output, load step from 40A to 1A; AC-coupled

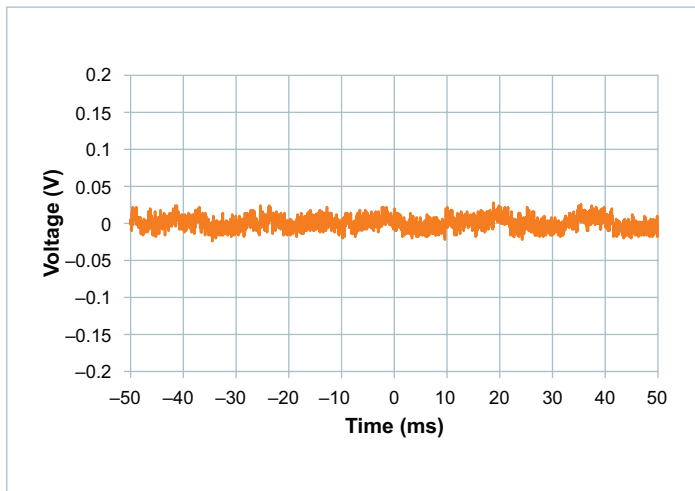

Figure 10 — VS1 (+12V) ripple with 40A load, AC-coupled

Application Characteristics (Cont.)

Load step response for all outputs being loaded from no load to 100% of their rated output simultaneously.

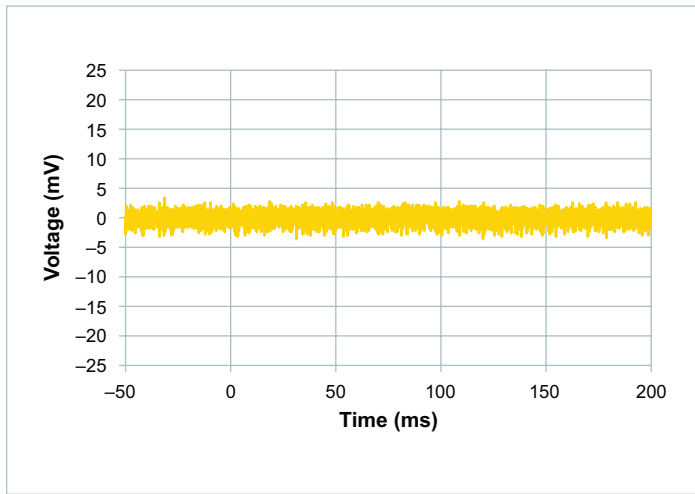

Figure 11 — VS2 (+3.3V) ripple with no load, AC-coupled

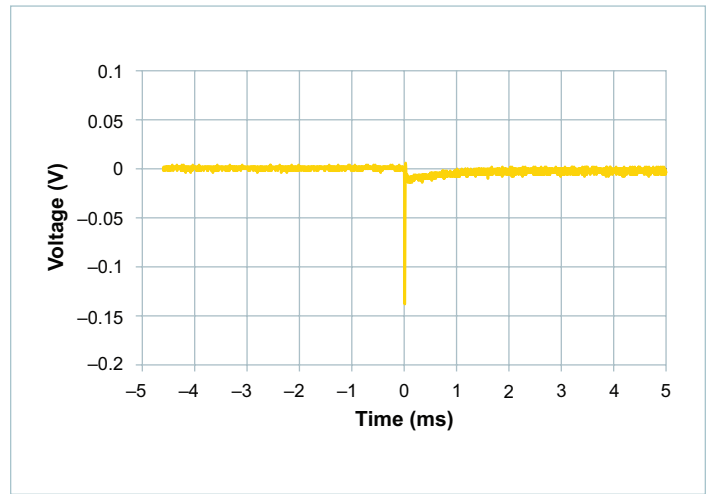

Figure 12 — Transient response of VS2 +3.3V output, load step from 0A to 20A; AC-coupled

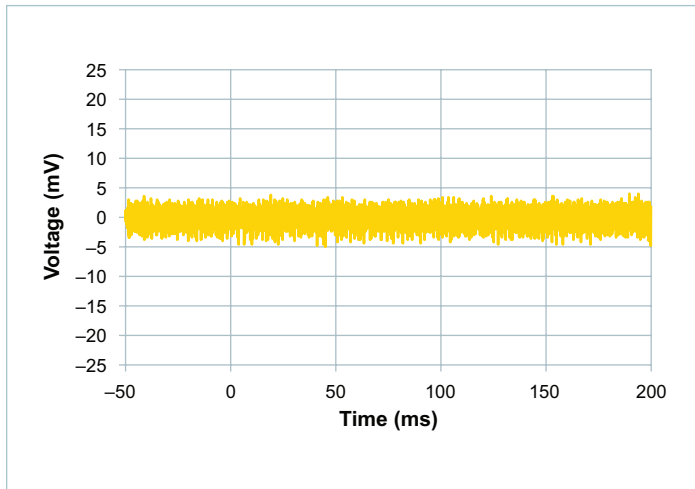

Figure 13 — VS2 (+3.3V) ripple with 20A load, AC-coupled

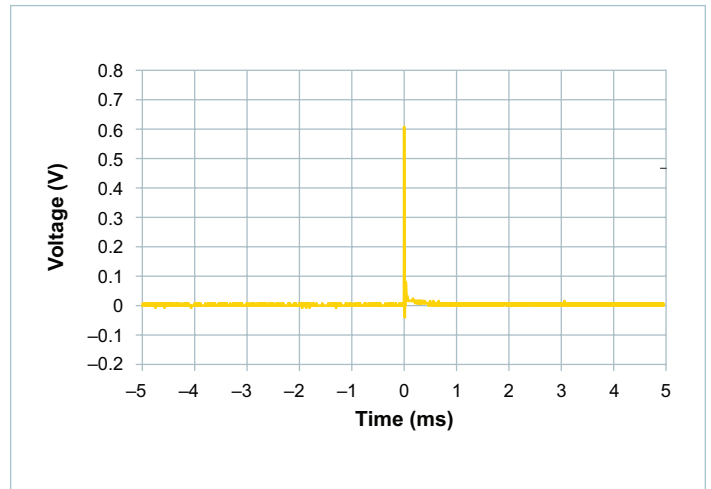

Figure 14 — Transient response of VS2 +3.3V output, load step from 20A to 0A; AC-coupled

Application Characteristics (Cont.)

Load step response for all outputs being loaded from no load to 100% of their rated output simultaneously.

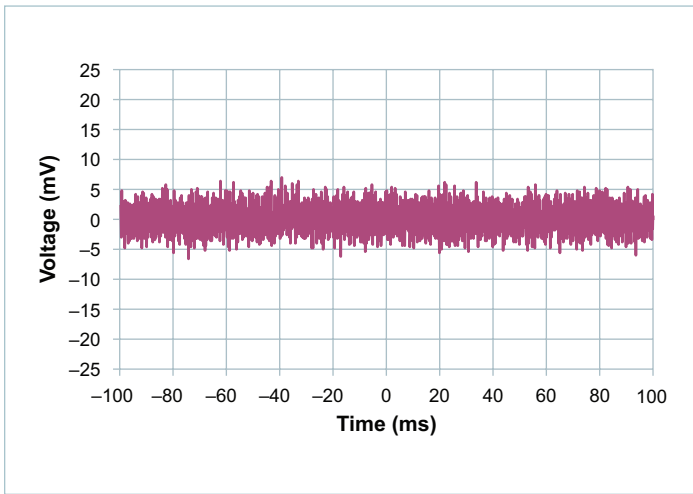

Figure 15 — VS3 (+5V) ripple with no load, AC-coupled

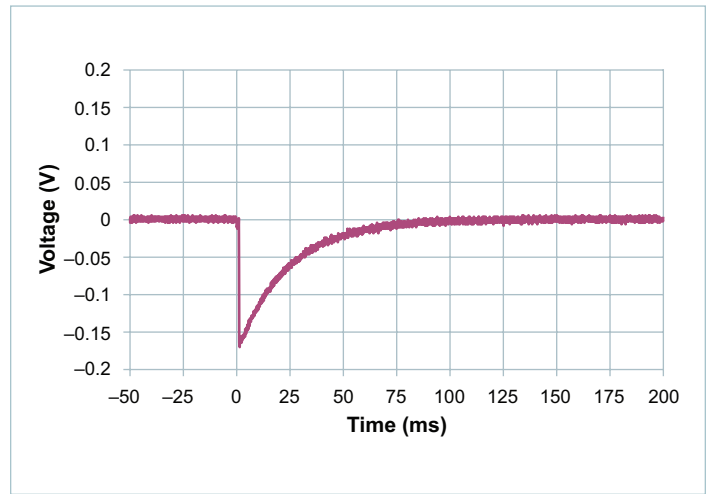

Figure 16 — Transient response of VS3 +5V output, load step from 0A to 30A; AC-coupled

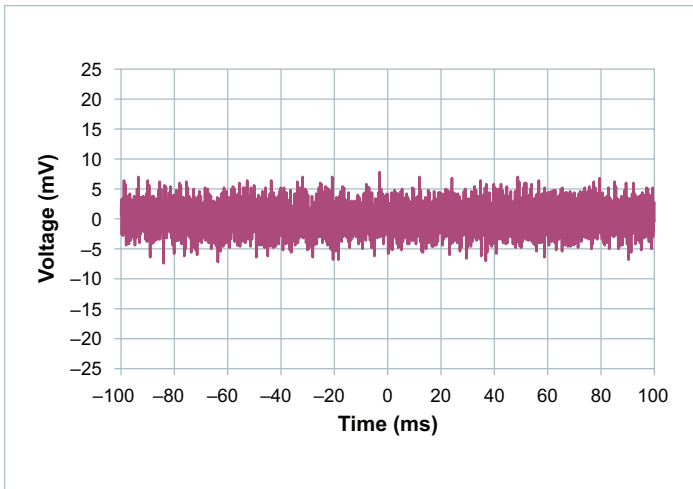

Figure 17 — VS3 (+5V) ripple with 30A load, AC-coupled

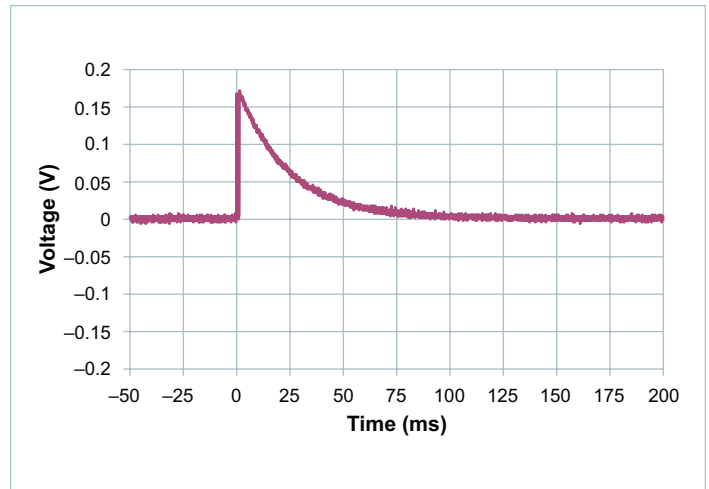

Figure 18 — Transient response of VS3 +5V output, load step from 30A to 0A; AC-coupled

Application Characteristics (Cont.)

Load step response for all outputs being loaded from no load to 100% of their rated output simultaneously.

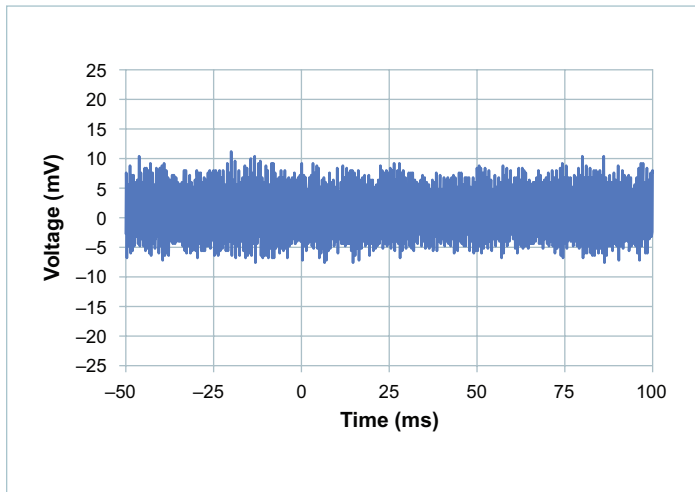

Figure 19 — AUX2 (+3.3V) ripple with no load, AC-coupled

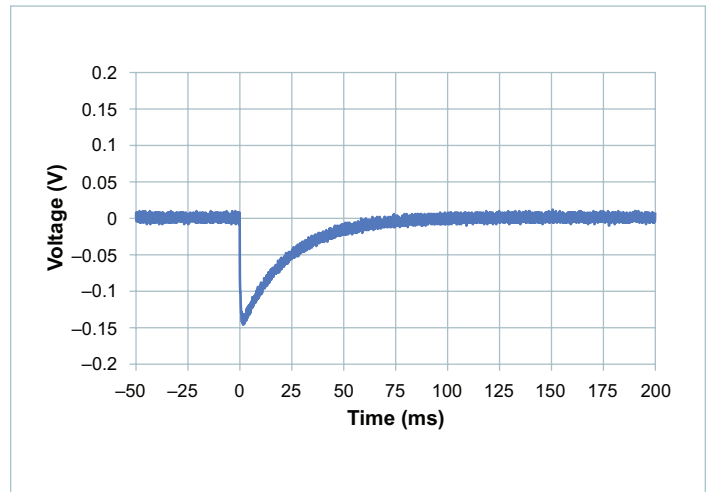

Figure 20 — Transient response of AUX2 +3.3V output, load step from 0A to 6A; AC-coupled

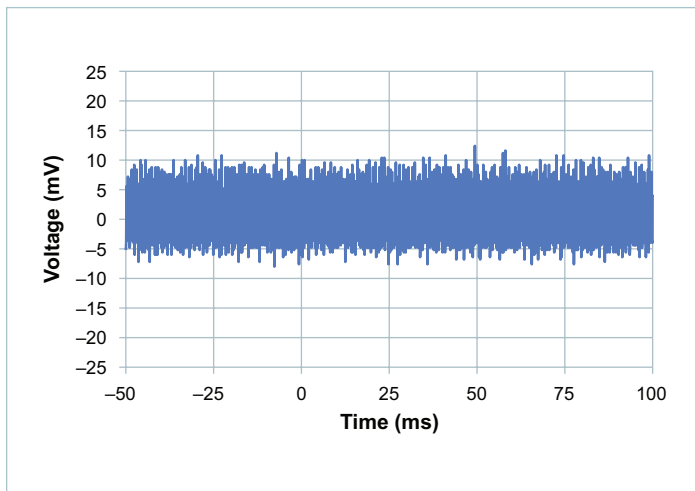

Figure 21 — AUX2 (+3.3V) ripple with 6A load, AC-coupled

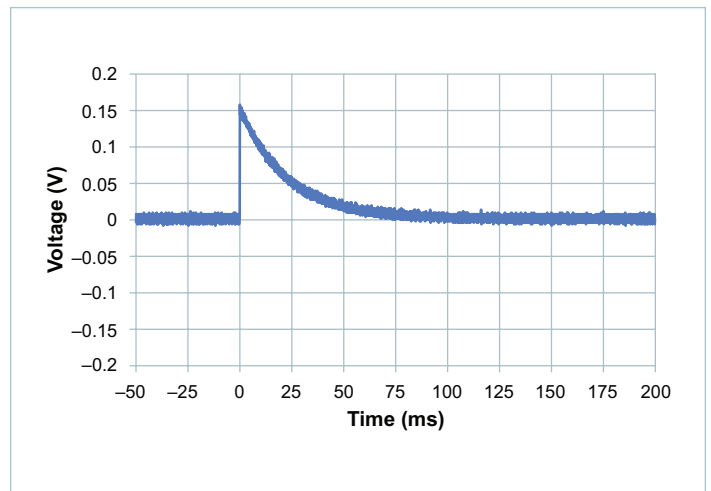

Figure 22 — Transient response of AUX2 +3.3V output, load step from 6A to 0A; AC-coupled

Application Characteristics (Cont.)

Load step response for all outputs being loaded from no load to 100% of their rated output simultaneously.

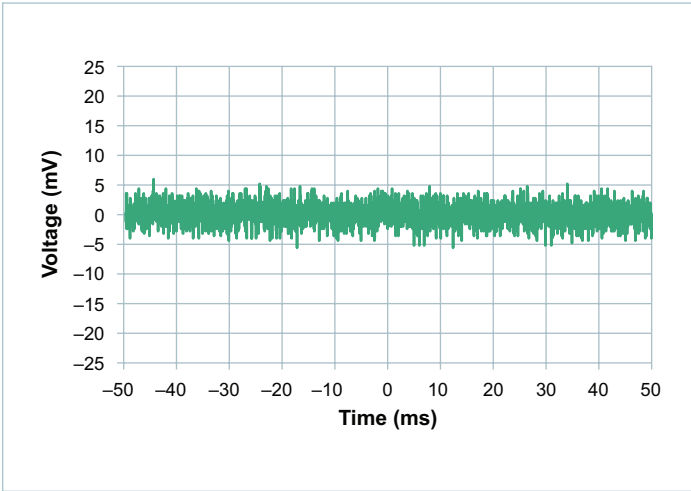

Figure 23 — AUX1 (-12V) ripple with no load, AC-coupled

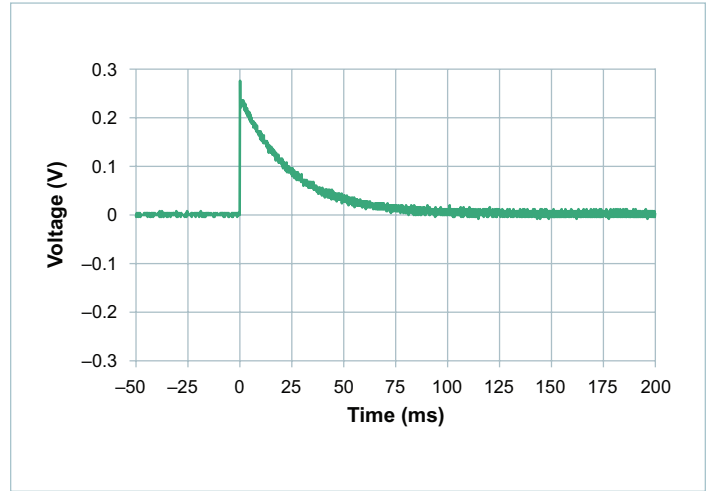

Figure 24 — Transient response of AUX1 -12V output, load step from 0A to 1A; AC-coupled

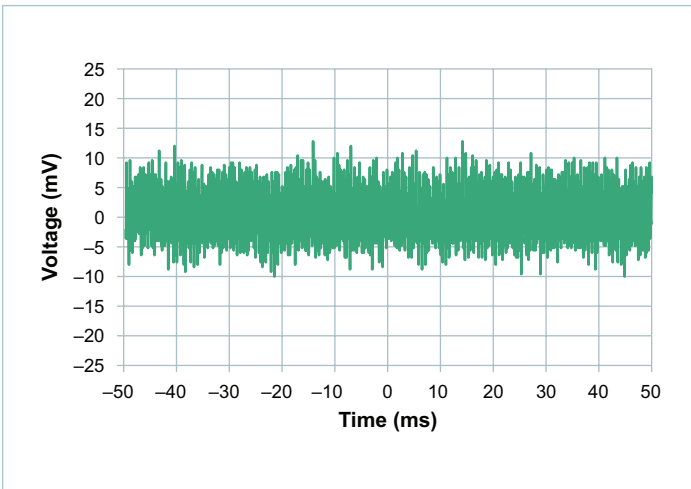

Figure 25 — AUX1 (-12V) ripple with 1A load, AC-coupled

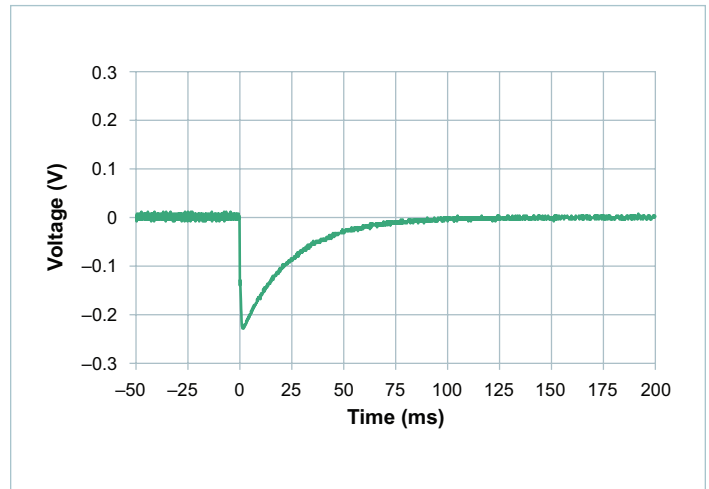

Figure 26 — Transient response of AUX1 -12V output, load step from 1A to 0A; AC-coupled

Application Characteristics (Cont.)

Load step response for all outputs being loaded from no load to 100% of their rated output simultaneously.

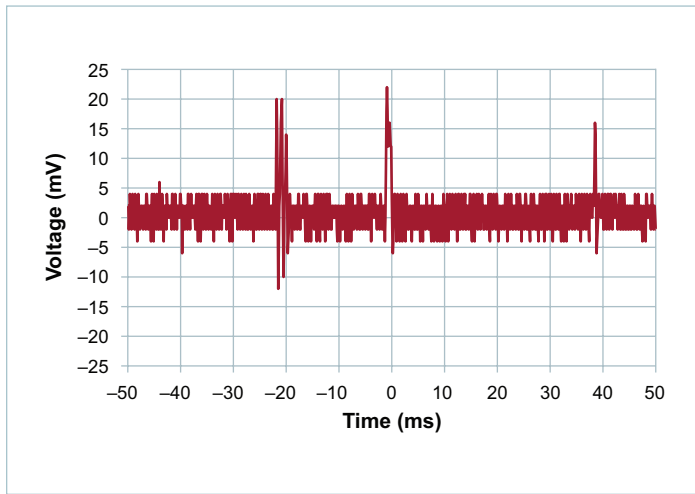

Figure 27 — AUX3 (+12V) ripple with 1A load and 5A load on VS1 (+12V), AC-coupled

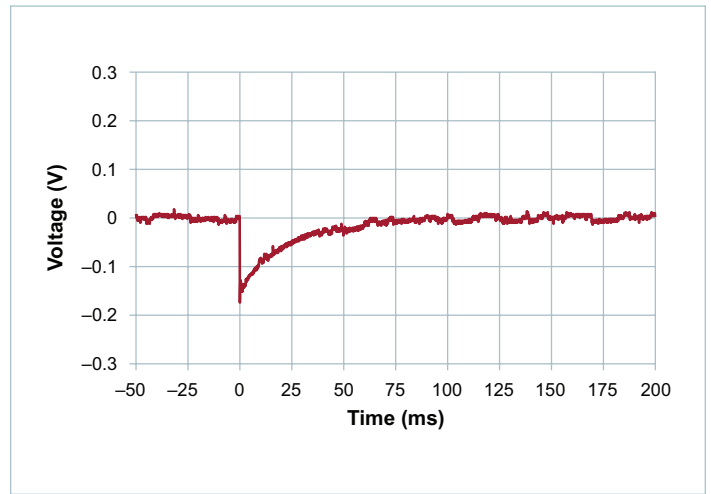

Figure 28 — Transient response of AUX3 +12V output, load step from 0A to 1A with 5A load on VS1 +12V; AC-coupled

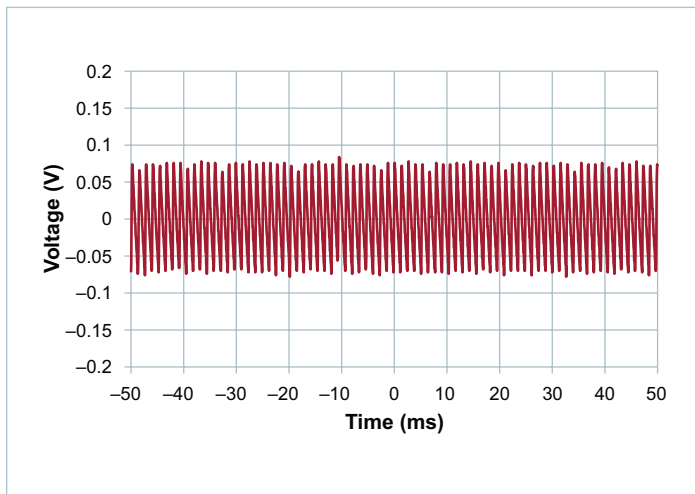

Figure 29 — AUX3 (+12V) ripple with no load on VS1, AC-coupled

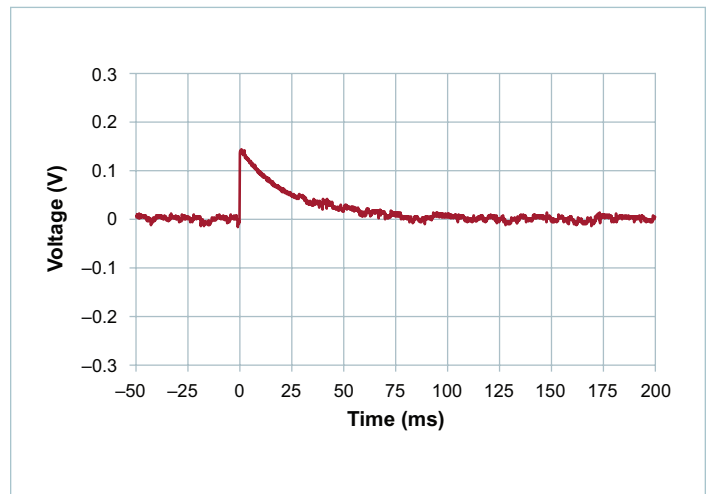

Figure 30 — Transient response of AUX3 +12V output, load step from 1A to 0A with 5A load on VS1 +12V; AC-coupled



## General Characteristics

Attribute	Symbol	Conditions / Notes	Min	Typ	Max	Unit
<b>Mechanical</b>						
Length	L	Per VITA62		6.634		in
Width	W	Per VITA62		3.937		in
Height	H	Per VITA62		0.951		in
Weight	W			685		g
Wedge-Lock Torque		Manufacturer's recommended value		7		in-lbs
<b>Thermal</b>						
Operating Temperature	T <sub>WEDGE-LOCKS</sub>		-40		85	°C
<b>Assembly</b>						
Storage Temperature			-55		125	°C
<b>Safety</b>						
MTBF		MIL-HDBK-217Plus Parts Count - 25°C Ground Benign, Stationary, Indoors / Computer		397,069		Hrs
		Telcordia Issue 2 - Method I Case III; 25°C Ground Benign, Controlled		789,845		Hrs

## Signal Pin Functions

### ENABLE\* & INHIBIT\*

Enable and Inhibit pins express active low logic. Table 1 has the truth table for the output state of the power supply. It is necessary to avoid the indeterminate output state where 0.8 – 2.0V is applied to the ENABLE\* or INHIBIT\* pins.

A digital debounce filter is present on the signals of both pins to prevent false transitions. The ENABLE\* and INHIBIT\* also have a minimum delay between successive output enable transitions to prevent repeated starts into high capacitance loads. See detailed specifications for delays time limits.

ENABLE* Pin	INHIBIT* Pin	Output State and Notes
< 0.8V, Logic 0	> 2.0V or NO, Logic 1	All outputs available
< 0.8V, Logic 0	< 0.8V, Logic 0	Only +3.3V <sub>AUX</sub> output available
> 2.0V or NO, Logic 1	Any	All outputs disabled
0.8V > V <sub>ENABLE*</sub> < 2.0V	0.8V > V <sub>INHIBIT*</sub> < 2.0V	Indeterminate state and must be avoided

Table 1 — ENABLE & INHIBIT logic

### Geographical Address: GA0\* & GA1\*

Geographical address pins also exhibit active low logic. Table 2 has the truth table for the output state of the power supply. It is necessary to avoid the indeterminate state where 0.8 – 2.0V is applied to either address pins. A digital debounce filter is present on the signals of both pins to incorrect address assignment.

The geographical address is static and set on power up. The power supply's address cannot not change until power has been cycled and the states of the address pins have been modified before power up.

## Typical External Circuits for Signal Pins

### (ENABLE\*, INHIBIT\*, GA0\*, GA1\*, SYSRESET\*, FAIL\* and I<sup>2</sup>C Channels)

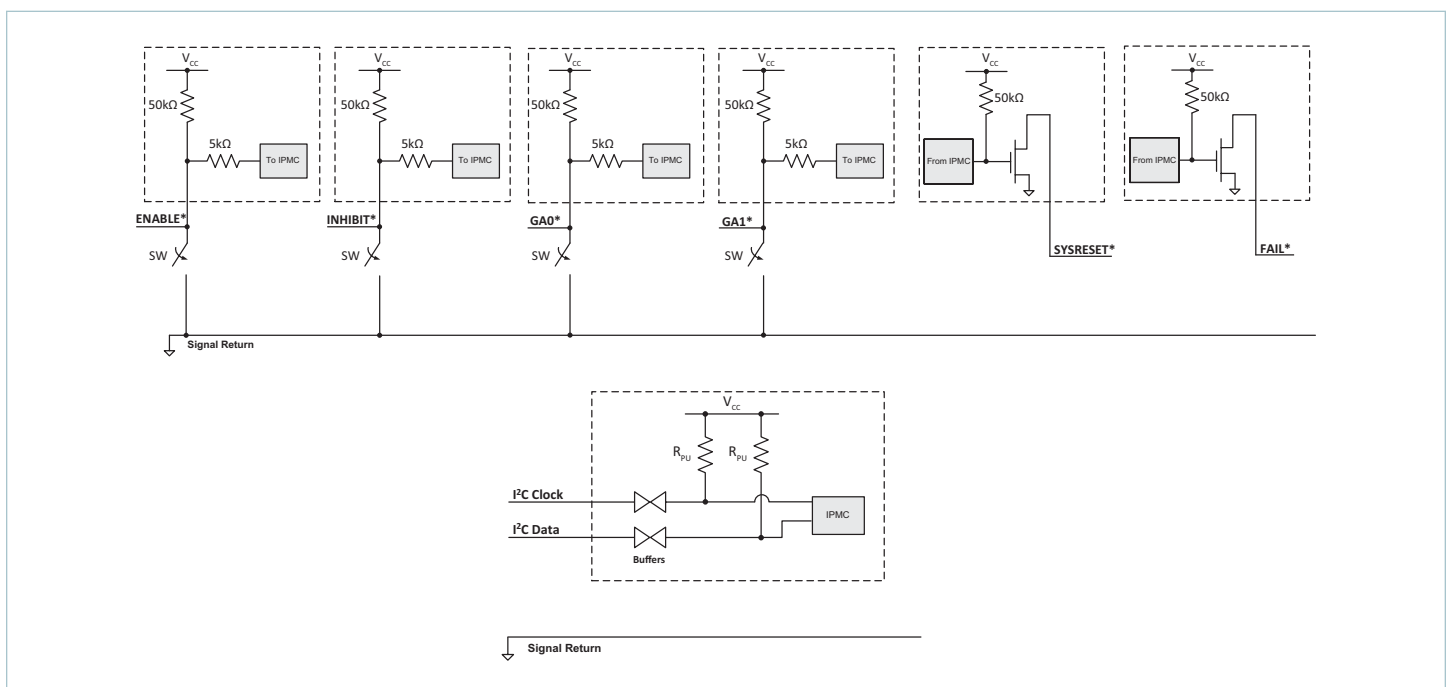

GA1*	GA0*	Power Supply Address
> 2.0V or NO, Logic 1	> 2.0V or NO, Logic 1	20h
> 2.0V or NO, Logic 1	< 0.8V, Logic 0	21h
< 0.8V, Logic 0	> 2.0V or NO, Logic 1	22h
< 0.8V, Logic 0	< 0.8V, Logic 0	23h
0.8V > V <sub>GA1*</sub> < 2.0V	0.8V > V <sub>GA0*</sub> < 2.0V	Indeterminate state and must be avoided

Table 2 — Geographical address assignment

### I<sup>2</sup>C Ports:

Both primary and redundant I<sup>2</sup>C™ ports have the same address set by the Geographical Address pins and identical functionality. There is a bidirectional buffer on both clock and data lines with internal pull ups on the IPMC and external pulls on the back plane to +3.3V are required.

### FAIL\*

This signal line is open drain and tracks SYSRESET\* when the unit is powering up or pulled down to SIGNAL\_RETURN when any of the outputs are out of specification. A pull up resistor is expected on the backplane per section 4.6.3.7 of VITA 62.

### SYSRESET\*

This signal line is open drain and is pulled down to SIGNAL\_RETURN when the unit is powering up. The line is released when the power supply is ready for control. Appropriate pull-up/pull-down resistors are expected on the back plane per VITA 46 section 7.3.9.

### SIGNAL RETURN

SIGNAL RETURN is used as the reference for signals pin connections and is to be tied to POWER\_RETURN on the backplane per section 4.6.3.10-1 of VITA 62.

## Card Edge Temperature Sensors

The PCBA card edge temperature sensor internal to the power supply is mounted on the edge of the PCBA card edge. Consequently, the temperature sensor measures a temperature that is generally higher than the heat-sink-to-rail mounting interface and lower than the hot spot of the internal converters in the power supply.

Response from the power supply to I<sup>2</sup>C™ command 0x21 provides the temperature measured by the internal sensor that reads the higher temperature. This temperature can exceed 85°C. I<sup>2</sup>C command 0x92 will respond with both PCB mounted temperature sensors.

## Power Limits

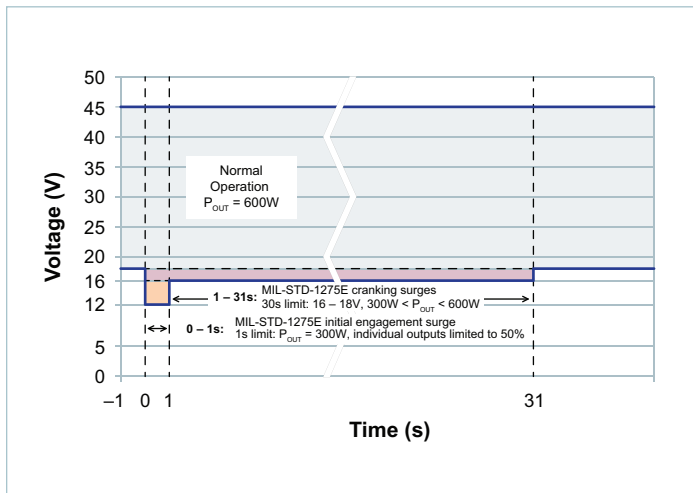

Figure 31 — Power-time limits during transient cranking disturbances

Per MIL-STD-1275E, the Initial Starter Engagement (ISE) can cause the nominal 28V bus to drop to 12V for a period of no more than 1s. During this time the available combined output power is required to be limited to 300W. Once the engine is cranking the voltage will be in the range of 16 – 18V and the full combined unit power of 600W is available but only for a maximum time of 30s due to the reduced input voltage.

## Fault Operation

See Table 5 for nonrecoverable fault thresholds which trigger a fault and shut down/restart of the outputs of the supply.

### Input Voltage Protection (IOVP)

If the input voltage to the power supply drops below  $V_{UV-IN}$  or exceeds  $V_{OV-IN}$  for at least 1ms, the power supply will shut down all outputs and digital communication lines until input voltage is within operating range  $V_{IN}$ . Triggering  $I_{OVP}$  has the same effect as power cycling the power supply. Supply currents and voltages are sampled every 200 $\mu$ s.

### Output Voltage Protection (OVP)

The power supply measures voltage from the remote-sense lines as well as the voltages on the VITA connector which do not include remote sense drop.

The FAIL\* line will be asserted (pulled low) when output voltage at the connector of the power supply is greater than the nonrecoverable limit of any output. OVP will also shut down the outputs until the output voltage of the converter is within specification. The power supply will automatically restart the outputs every 1s until the fault clears.

### Overcurrent Protection (OCP)\*

During an overcurrent fault on any output, all outputs will shut off and the FAIL\* line will be asserted. The power supply will automatically try to restart outputs every 1s if the fault has cleared.

### Overtemperature Protection (OTP)

The power supply will go into overtemperature protection and shut down all outputs when either internal temperature sensor measures 95°C. The power converter will recover for normal operation when the internal temperature has dropped by 20°C.

At 85°C the Bit-5 of the Status Register (0x55) will clear if the system manager sets Bit-5 to 1 which will indicate the power supply is within 10°C from shutting down.

## Parallel Operation

For proper load regulation and paralleling of like power supplies, a single kelvin connection between each sense pin and load is required. Under normal parallel power supply operation, each supply's PoL regulated output will be at different voltage with respect to its own backplane connector to compensate for transmission voltage drop. Figure 32a depicts an instance of a backplane with three power supplies where the point-of-load (PoL) sense pins on each power supply are connected.

It is not recommended to connect the PoL sense pins in a manner depicted in Figure 32b where each supply's PoL sense pins are connected to each other and also to each power supply's own PoL voltage output. In this case the system may appear to function normally temporarily but load regulation and sharing are not guaranteed due to the lack of a kelvin connection between the supplies and a single load point.

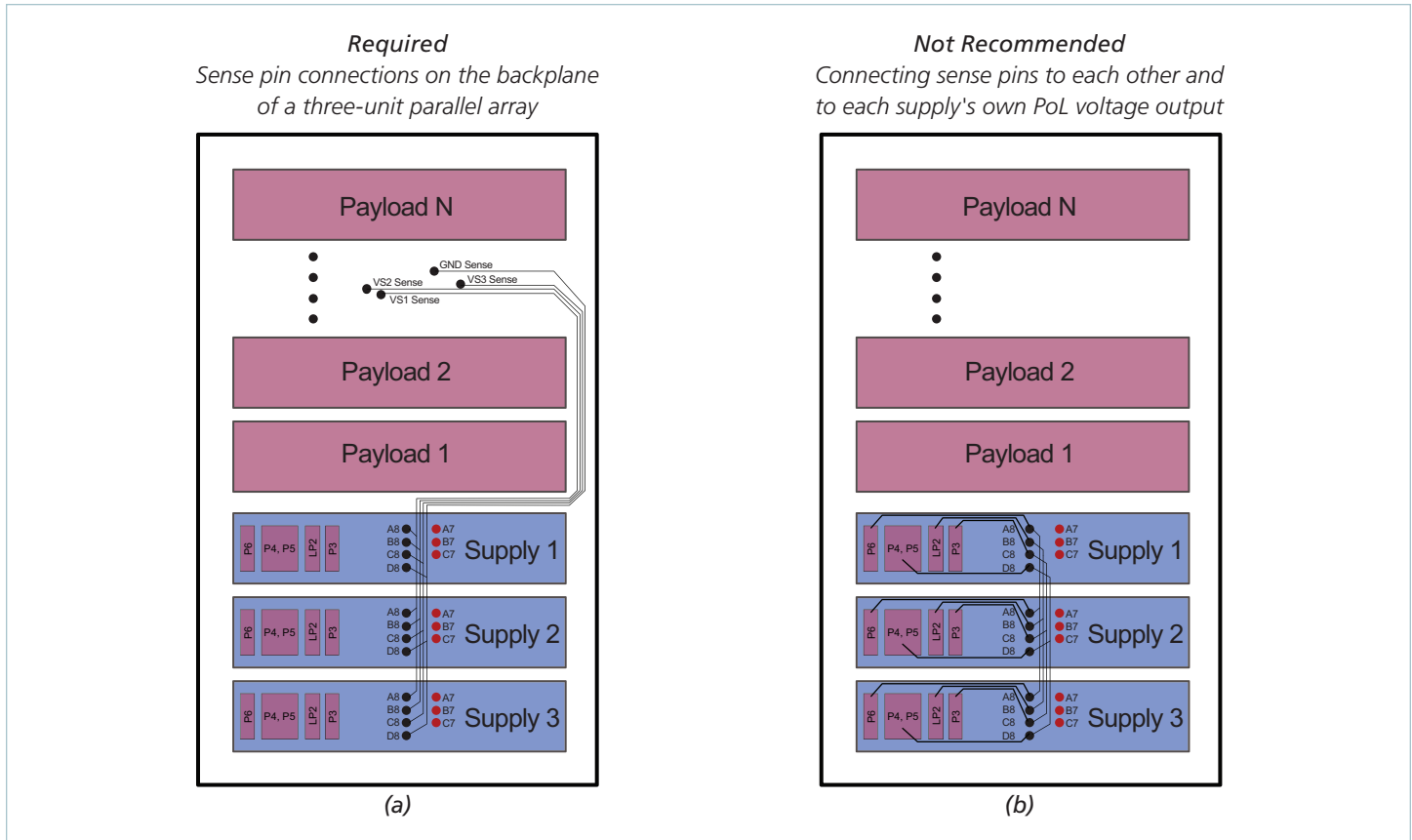

**Figure 32** — Sense pin connection arrangement connects all supplies to the backplane of the array

All six outputs can be connected in parallel with the same output from other power supplies with the same part number. Only VS1, VS2 and VS3 support load sharing. The combined current output of paralleled AUX outputs is limited to the ampacity of respective individual AUX outputs of a single power supply.

Additional information on power supply paralleling can be found in [AN:801 – Parallel Operation](#).

Output	Max Current vs. Paralleled Supplies				Unit
	1	2	3	4	
VS1 (+12V)	40	72	108	144	A
VS2 (+3.3V)	20	36	54	72	A
VS3 (+5V)	30	54	81	108	A
VAUX1 (-12V)	1	1	1	1	A
VAUX2 (+3.3V)	6	6	6	6	A
VAUX3 (+12V)	1	1	1	1	A

**Table 3** — Maximum current rating by output for parallel arrays

## Standalone Operation

Switching the power supply from paralleling to standalone can be done on a single-use basis or permanently by the user using I<sup>2</sup>C™.

Each unit ships from the factory capable of paralleling multiple identical power supplies. If the power supply is used in standalone mode without additional identical supplies connected in parallel, the output voltages of the power supply that are shareable, namely, VS1, VS2 and VS3, will not droop with increased current load and will regulate the output voltage close to the no-load voltage. The standalone mode of operation may be desirable in applications where output voltage tolerance requirements exceed the limits allowed by VITA 62 and only one power supply is required.

In order to set the power supply to standalone mode the byte sequence shown in Table 4 needs to be transmitted to the power supply.

IPMB Byte Number	Hex Byte	Comment
0	40h	Initiation of Communication; transmit request to the power supply. Address byte of power supply with hardware address 0x20 and LSB read/write low.
1	66h	Command byte 1
2	99h	Command byte 2
3	10h	Command byte 3
5	F1h	Zero checksum of IPMB bytes 1-3 and Stop Bit

**Table 4** — Byte sequence to set the power supply in standalone

To verify if the power supply is in standalone mode, VS1 remote-load sense voltage can be measured between connector pin A8 and sense return D8. The voltage between A8 and D8 will drop less than 40mV between no-load and full-load. If the power supply is in paralleling mode, VS1 remote-load sense voltage measured between connector pin A8 and sense return D8 will vary over 100mV between no-load and full-load.

To set the power supply to share mode again, command byte 3 in Table 4 needs to change to 00h. The checksum for bytes 1 – 3 will need to be recalculated and transmitted to the power supply. The sequence will need to be transmitted to the power supply a total of 3 times for the power supply to permanently change its mode at power up to support current share or paralleling.

To permanently change the power supply to either standalone or paralleling mode, the sequence in Table 4 with byte 3 set correctly needs to be transmitted three times consecutively. Committing the change permanently will cause the power supply to adopt the desired mode of operation from power up. If the power supply mode of operation is changed permanently, the power supply will perform a soft reboot once to store settings in its internal memory. The power supply can be switched from paralleling to standalone and vice-versa permanently up to 100,000 times due to memory wear limitations. Switching mode of operation without committing changes permanently can be done as many times as the user requires. If the mode of operation is switched without committing the change permanently, the power supply will revert to the mode of operation set permanently after a power cycle.

Conducted Emissions Testing

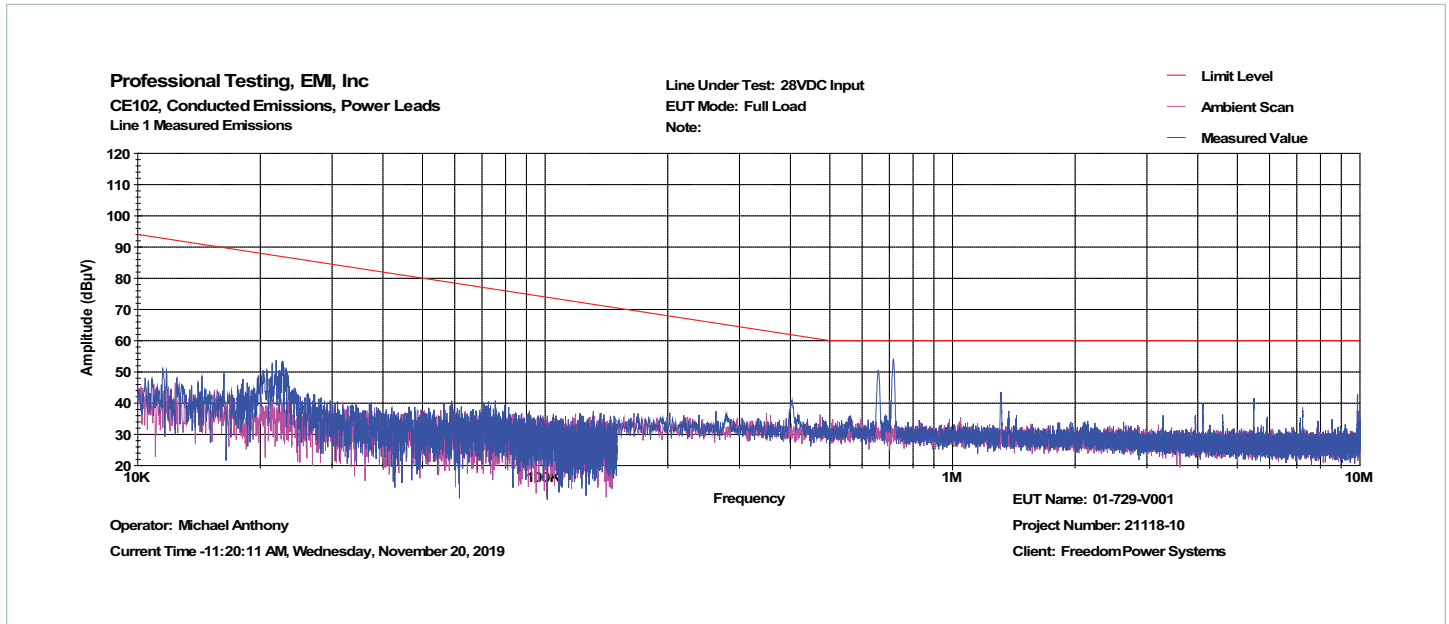

Figure 33 — Conducted emissions of 28V<sub>DC</sub> input at full load

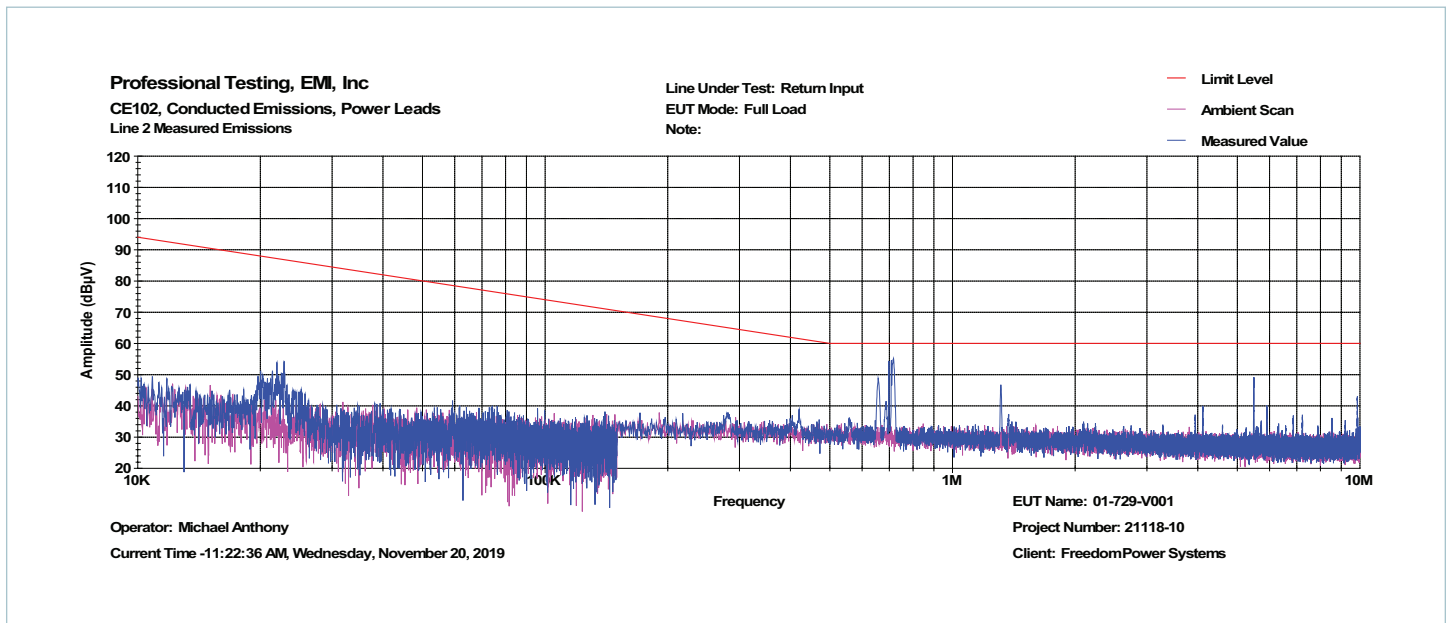

Figure 34 — Conducted emissions of power return at full load

Conducted Emissions Testing (Cont.)

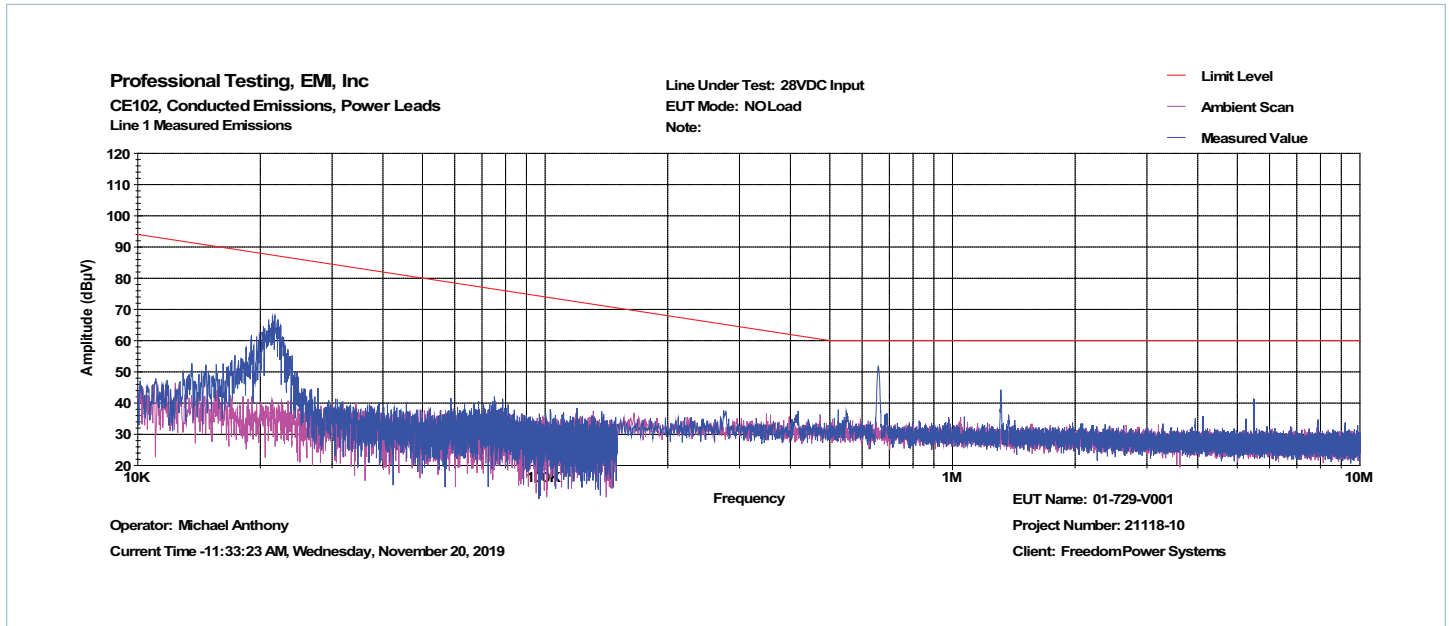

Figure 35 — Conducted emissions of 28V<sub>DC</sub> input at no load

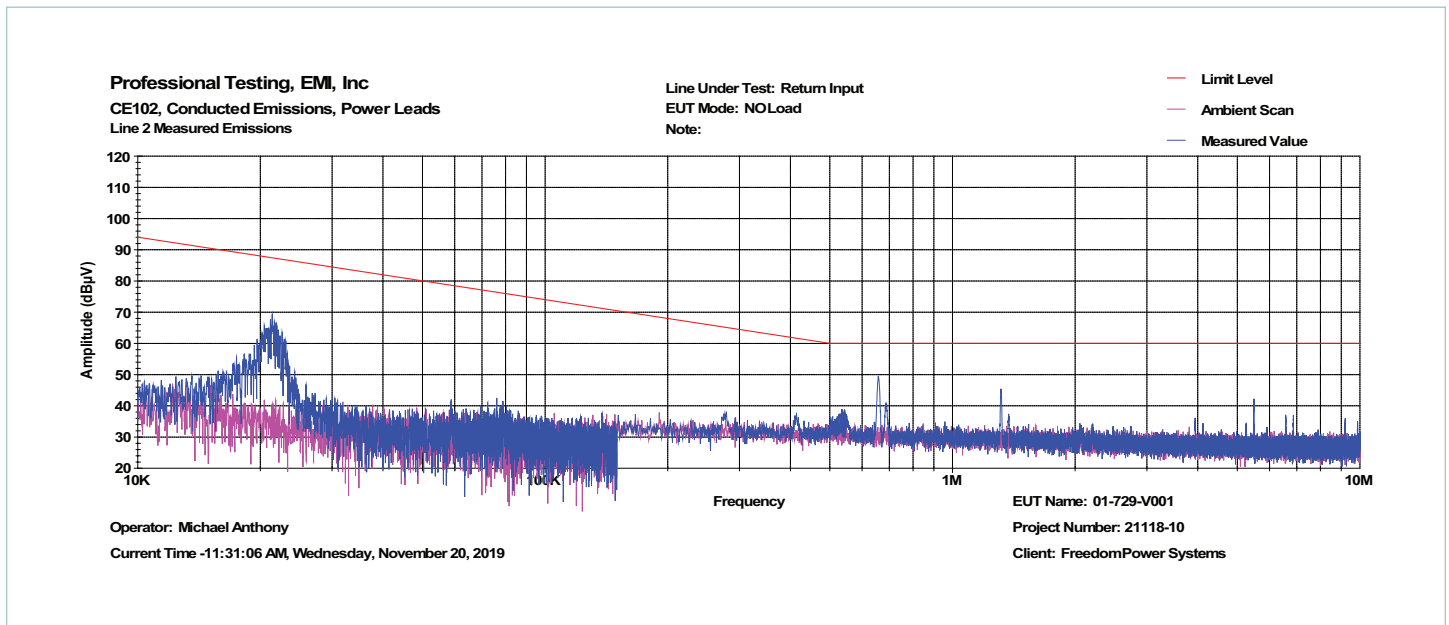

Figure 36 — Conducted emissions of power return at no load

## Standards Compliance

MIL-STD-461F		
CS06	±200V, 10µs	Pass
	±400V, 5µs	Pass
	1000 – 2000Hz PSD decreasing at 6dB/octave	Pass
CS115	Bulk input power cables	Pass
	Bulk output power cables	Pass
CS116	Bulk input power cables	Pass
	Bulk output power cables	Pass
MIL-STD-461G		
CE102	Basic curve	Pass
CS101	Figure CS101-1, Cuve #2	Pass
CS114 Curve 5	Input power lead	Pass
	Bulk input power cables	Pass
MIL-STD-704F		
LDC103 – Voltage Distortion Spectrum		Pass
LDC105 – Normal Voltage Transients		Pass
LDC302 – Abnormal Voltage Transients		Pass
MIL-STD-810G		
Vibration, Method 514.5 Procedure I	1 – 100Hz PSD increasing at 3dB/octave	Pass
	100 – 1000Hz PSD = 0.1g <sup>2</sup> /Hz	Pass
	1000 – 2000Hz PSD decreasing at 6dB/octave	Pass
Operating Shock, Method 516 Procedure I	40g, 11ms shock half-sine	Pass
	40g, 11ms, terminal saw-tooth shock pulses in all three axes	Pass
MIL-STD-1275E		
All Sections	12V initial engagement surge limited to 300W output power	Pass
RTCA/DO-160G		
Section 15: ESD		Pass
Section 17: Voltage Spike, Category A		Pass
IEC 61000-4-2		
ESD, Level 4	±15kV Air Discharge	Pass
VITA 47		
Humidity	Method 507 per VITA 47 Section 4.6	Pass
Operating Temperature	VITA 47 Section 4.1.2 class CC4	Pass
Temperature Cycling	MIL-STD-202 Method 107 per VITA 47 Section 4.3	Pass
Altitude	1,500ft below sea level to 70,000ft above sea level	Pass
Fungus Resistance	MIL-STD-810G, Method 508 per VITA47 Section 4.10	Pass
Corrosion Resistance	ASTM G85, Annex A4, cycle A4.4.4.1 per VITA 47 Section 4.12	Pass



## I<sup>2</sup>C™ Sensor Commands

Commands are sent by SMBus-compatible packets over the I<sup>2</sup>C physical interface. The I<sup>2</sup>C bus will communicate at 100kHz. Pull-up resistors to +3.3V are expected on the system backplane.

Two pins, labeled \*GA1 and \*GA0 are provided at each power supply slot, where \*GA1 and \*GA0 are defined to be active (SET) when low. The power supply will respond to I<sup>2</sup>C address 010 00[GA1][GA0].

The power supply supports commands to read sensor data from the power supply without utilizing VITA 46.11 or IPMI. The commands are similar to register reads in from I<sup>2</sup>C memory and function in a parent/child configuration. Unlike VITA 46.11 which is a multi-parent protocol, commands defined in this section are parent-write and parent-read.

Table 5 shows the following transmission pattern for reading power supply rail temperatures with command 0x92 using the parent-write/parent-read transmission format. In all non-VITA 46.11 commands, the parent requests the data from the child, which is the power supply.

IPMB Byte Number	Hex Byte	Clock Pulses Generated By	Data Pulses Generated By	Comment	Real Value
1	40h	Requestor	Requestor	Initiation of Communication; transmit request to the power supply; Address byte of power supply with hardware address 0x20 and LSB read/write low	
2	92h	Requestor	Requestor	Command to read power supply temperatures	
3	6Eh	Requestor	Requestor	Zero checksum generated from IPMB byte 2 (or all bytes after Address Byte up to the checksum byte)	
4	41h	Requestor	Requestor	Read response from the power supply; Address byte of power supply with hardware address 0x20 and LSB read/write high	
5	92h	Requestor	Power Supply	Response byte 1 Echo of the command from the requestor	
6	01h	Requestor	Power Supply	Response byte 2	013Bh = 31.5°C
7	3Bh	Requestor	Power Supply	Response byte 3	
8	01h	Requestor	Power Supply	Response byte 4	0146h = 32.6°C
9	46h	Requestor	Power Supply	Response byte 5	
10	EBh	Requestor	Power Supply	Zero checksum of IPMB bytes 6-9	

**Table 5** — Communication example of command non-VITA 46.11 command 0x92

Checksum bytes are 2's complement checksum of bytes in the request excluding the address byte or between the previous checksum and next checksum excluding the address byte.

### 8-bit checksum algorithm:

1. Initialize checksum to 0.
2. For each applicable byte, checksum = (checksum + byte) modulo 256.
3. Then checksum = - checksum.

### Verification

When the checksum and the bytes are added together, modulo 256, the result should be 0.

Example of the checksum for the data returned by the power supply in Table 5.

$$\Leftrightarrow 256 - \left( \sum_{x=5}^9 IPMB\_Bytes\ x \right) \bmod 256 = EBh$$

$$\Leftrightarrow 256 - \left( (92h + 01h + 3Bh + 01h + 46h) \bmod 256 \right) = EBh$$

Verification:

$$\left( EBh + (92h + 01h + 3Bh + 01h + 46h) \right) \bmod 256 = 0$$

Table 6 shows how to set and read the Status Register Byte.

Checksum bytes are 2's complement checksum of bytes in the request excluding the address byte or between the previous checksum and next checksum excluding the address byte.

IPMB Byte Number	Hex Byte	Clock Pulses Generated By	Data Pulses Generated By	Comment
<b>Status Register READ</b>				
0	40h	Requestor	Requestor	IPMB address write
1	55h	Requestor	Requestor	Command
2	ABh	Requestor	Requestor	Zero checksum
3	41h	Requestor	Requestor	Read response
4	55h	Requestor	Power Supply	Echo command
5	02h	Requestor	Power Supply	Status register: hardware control, all outputs enabled
6	A9h	Requestor	Power Supply	Zero checksum
<b>Status Register WRITE</b>				
0	40h	Requestor	Requestor	IPMB address write
1	55h	Requestor	Requestor	Command
2	18h	Requestor	Requestor	Software control, all outputs enabled
3	93h	Requestor	Requestor	Zero checksum
4	41h	Requestor	Requestor	Read response
5	55h	Requestor	Power Supply	Echo command
6	1Ah	Requestor	Power Supply	Status register: software control, all outputs enabled
7	91h	Requestor	Power Supply	Zero checksum

**Table 6** — Communication example of status register byte

## Commands Recognized by Power Supply

0x21: Sensor Data (Read Only) <sup>[d]</sup>			
Byte Number	Contents	Format	Scaling
0	0x21	Byte	Echo of the command
1	Status Reg	Byte	See below, same as used by command 0x55
2, 3	PCBA Temperature °C	UINT16	16384 = 100°C
4, 5	+12V VSENSE	UINT16	16384 = 12.0V
6, 7	+3.3V VSENSE	UINT16	16384 = 3.3V
8, 9	+5V VSENSE	UINT16	16384 = 5.0V
10, 11	+3.3VAUX VSENSE	UINT16	16384 = 3.3V
12, 13	+12VAUX VSENSE	UINT16	16384 = 12.0V
14, 15	-12VAUX VSENSE	UINT16	16384 = -12.0V, absolute value
16, 17	+12V IOUT	UINT16	16384 = 40A
18, 19	+3.3V IOUT	UINT16	16384 = 20A
20, 21	+5V IOUT	UINT16	16384 = 30A
22, 23	+3.3VAUX IOUT	UINT16	16384 = 6A
24, 25	+12VAUX IOUT	UINT16	16384 = 1A
26, 27	-12VAUX IOUT	UINT16	16384 = -1A, absolute value
28, 29	INT REFERENCE	UINT16	16384 = 2.50V
30, 31	Input Voltage	UINT16	16384 = 28V
32 – 51	Part Number	CHAR[20]	no 0 term, padded with 0x20
52 – 55	Serial Number	UINT32	Unsigned 32-bit integer; last 9 digits of the serial number of the unit on the label
56, 57	Factory Use Only	UINT16	N/A: factory use only
58, 59	Hardware Rev	CHAR[2]	
60, 61	Firmware Rev	CHAR[2]	
62	Input Current	UINT8	255 = 60A
63	Zero Checksum	Byte	Sum(Bytes 0:63) mod 256 = 0

<sup>[d]</sup> Most-significant bit of each byte is transmitted first.  
Most-significant byte of UINT16 and UINT32 transmitted first.

## Non-VITA 46.11 Recognized by Power Supply

0x44: Firmware Date (Read Only) <sup>[e]</sup>			
• 22 byte response in ASCII form.			
Byte Number	Contents	Format	Typical Value/Comment
0	0x44	Byte	Echo of the command
1 – 20	Date	ASCII[20]	'NOV 28 14:32:54 2018'
21	Zero Checksum	Byte	Sum(Bytes 0:21) mod 256 = 0
0x45: Hardware Address (Read Only) <sup>[e]</sup>			
Byte Number	Contents	Format	Typical Value/Comment
0	0x45	Byte	
1	I <sup>2</sup> C Address	Byte	0x23, set by *GA1, *GA0
2	Zero Checksum	Byte	Sum(Bytes 0:2) mod 256 = 0
0x55: Status Command (Read/Write) <sup>[e]</sup>			
Byte Number	Contents	Format	Typical Value/Comment
0	0x55	Byte	
1	Status Byte	Byte	0x18 = All outputs ON
2	Zero Checksum	Byte	Sum(Bytes 0:2) mod 256 = 0
0x90: All Voltages in mV (Read Only) <sup>[e]</sup>			
Byte Number	Contents	Format	Scaling/Comment
0	0x90	Byte	Echo of the command
1, 2	+12V SENSE	UINT16	10mV/bit
3, 4	+3.3V SENSE	UINT16	10mV/bit
5, 6	+5V SENSE	UINT16	10mV/bit
7, 8	+3.3VAUX SENSE	UINT16	10mV/bit
9, 10	+12VAUX VSENSE	UINT16	10mV/bit
11, 12	-12VAUX VSENSE	UINT16	-10mV/bit
13, 14	Input Voltage	UINT16	10mV/bit
15	Zero Checksum	Byte	Sum(Bytes 0:15) mod 256 = 0

<sup>[e]</sup> Most-significant bit of each byte is transmitted first.  
Most-significant byte of UINT16 and UINT32 transmitted first.

## Non-VITA 46.11 Recognized by Power Supply (Cont.)

0x99: Main Outputs – Output and Input Current in mA (Read Only) <sup>[e]</sup>			
Byte Number	Contents	Format	Scaling/Comment
0	0x99	Byte	Echo of the command
1, 2	+12V IOUT	UINT16	10mA/bit
3, 4	+3.3V IOUT	UINT16	10mA/bit
5, 6	+5V IOUT	UINT16	10mA/bit
7, 8	Input Current	UINT16	10mA/bit
9	Zero Checksum	Byte	Sum(Bytes 0:9) mod 256 = 0
0x91: Auxiliary Outputs – Output Current in mA (Read Only) <sup>[e]</sup>			
Byte Number	Contents	Format	Scaling/Comment
0	0x91	Byte	Echo of the command
1, 2	+3.3VAUX IOUT	UINT16	1mA/bit
3, 4	+12VAUX IOUT	UINT16	1mA/bit
5, 6	-12VAUX IOUT	UINT16	-1mA/bit
7	Zero Checksum	Byte	Sum(Bytes 0:7) mod 256 = 0
0x92: PCBA Card Edge Temperatures in °C x 10 (Read Only) <sup>[e]</sup>			
Byte Number	Contents	Format	Scaling/Comment
0	0x92	Byte	Echo of the command
1, 2	3U P0 connector, P1 side Rail	INT16	Temperature x 10, eg. -123 = -12.3°C
3, 4	3U P0 connector, P6 side Rail	INT16	Same as above
5	Zero Checksum	Byte	Sum(Bytes 0:5) mod 256 = 0

**Status Register Bit Map used in command 0x55**

Bit 0 and 1 allow you to monitor what the power supply is reading from the input connector.

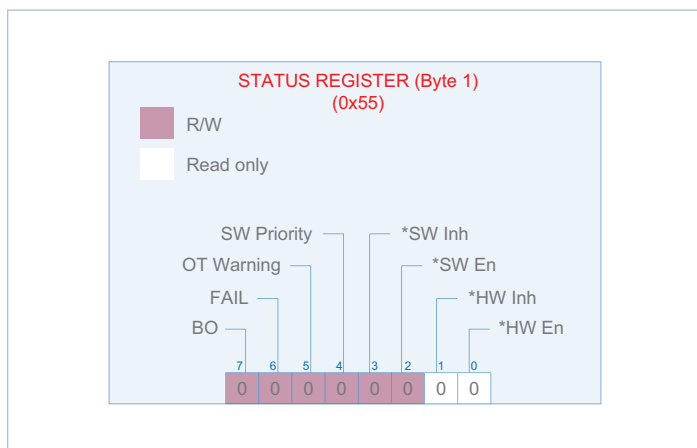

Bit	Name	Condition	Default
7	BO	Battle override; see description	0
6	FAIL	If set to 1 by System Manager, a fault condition will clear this bit.	0
5	OT Warning	If set to 1 by System Manager, an OT fault will clear this bit.	0
4	SW Priority	<b>Software Priority</b> 1 = STATUS REGISTER overrides hardware inputs for INHIBIT* and ENABLE* 0 = Hardware is in control	0
3	*SW Inh	<b>Software Inhibit</b> 0 = Inhibit active (same as hardware input state)	0
2	*SW En	<b>Software Enable</b> 0 = Enable active (same as hardware input state)	0
1	*HW Inh	Status of INHIBIT* pin (read only)	From backplane
0	*HW En	Status of ENABLE* pin (read only)	From backplane

Under some conditions, it is desirable to ignore potentially damaging conditions. For this purpose the power supply provides a battle override function in the system status register. If bit 7 in the status register is set, then any non-recoverable events that would normally shut down the supply will not do so.

Event messages are still sent, but the power supply will continue to operate until the conditions cease to exist or it fails.

In order to enable battle override mode, the command message must include the exact same data byte three times in a row within the message where normally only a single byte would be needed.

IPMB Byte Number	Hex Byte	Clock Pulses Generated By	Data Pulses Generated By	Comment
1	40h	Requestor	Requestor	Address byte of power supply with hardware address 0x20 and LSB read/write low.
2	55h	Requestor	Requestor	Command byte. Request 1
3	80h	Requestor	Requestor	Only set BO.
4	2Bh	Requestor	Requestor	Zero checksum generated from IPMB bytes 2 – 3 and Stop Bit.
5	40h	Requestor	Requestor	Address byte of power supply with hardware address 0x20 and LSB read/write low.
6	55h	Requestor	Requestor	Command byte. Consecutive request 2
7	80h	Requestor	Requestor	Only set BO. Byte identical to IPMB byte 3.
8	2Bh	Requestor	Requestor	Zero checksum generated from IPMB Bytes 6 – 7 and Stop Bit.
9	40h	Requestor	Requestor	Address byte of power supply with hardware address 0x20 and LSB read/write low.
10	55h	Requestor	Requestor	Command byte. Consecutive request 3
11	80h	Requestor	Requestor	Only set BO. Byte identical to IPMB byte 3.
12	2Bh	Requestor	Requestor	Zero checksum generated from IPMB bytes 10 – 11. Battle override enabled after byte 12 is processed by the power supply IPMC.
13	40h	Requestor	Requestor	Address byte of power supply with hardware address 0x20 and LSB read/write high.
14	55h	Requestor	Requestor	Command byte.
15	ABh	Requestor	Requestor	Zero checksum generated from IPMB byte 14 and Stop Bit.
16	41h	Requestor	Requestor	Address byte of power supply with hardware address 0x20 and LSB read/write high.
17	55h	Requestor	Power Supply	Echo Command byte.
18	82h	Requestor	Power Supply	Status register byte showing power supply is in battle override, enabled and not inhibited.
19	29h	Requestor	Power Supply	Zero checksum generated from IPMB bytes 17 – 18 and Stop Bit.

**Table 7** —  $\hat{P}C^{\text{TM}}$  communication example for battle override

## IPMI Interface

The data interface is compliant with the requirements of VITA 46.11, VITA 62 -2016 and the IPMI v2.0 specifications. This section shows product specific information such as a sensor list and their coefficients.

### Data Format

Four constants are used to calculate a real world value from the single byte variable returned in the response. The four constants are used in the equation Interpreting Received Values

$$y = (Mx + (B \cdot 10^{K1})) \cdot 10^{K2}$$

Where:

- y** the converted reading
- x** the raw sensor reading
- M** the signed integer multiplier
- B** the signed additive offset
- K1** signed exponent for constant B (sets decimal point for B)
- K2** signed result exponent (sets decimal point for y)

### Sensors and Constants

The list of sensors and coefficients can also be retrieved by the chassis manager by querying the "Sensor Data Record" (See VITA 46.11).

Sensor Number	Hex	Sensor Name	Type Code	Description	SI Units	M	B	K1	K2
2	02h	FRU Health	F2h	04h - Predictive Failure	Discrete				
3	03h	FRU Voltage	02h	05h - Limit Exceeded	Discrete				
4	04h	FRU Temperature	F3h	6Fh - Sensor Specific	Discrete				
7	07h	Input Voltage	02h	01h - Threshold	V	20	90	1	-2
8	08h	VS1, +12V Voltage	02h		V	20	90	2	-3
9	09h	VS2, +3.3V Voltage	02h		V	10	20	2	-3
10	0Ah	VS3, +5V Voltage	02h		V	10	35	2	-3
11	0Bh	AUX2, +3.3VAUX Voltage	02h		V	10	20	2	-3
12	0Ch	AUX3, +12VAUX Voltage	02h		V	20	90	2	-3
13	0Dh	AUX1, -12VAUX Voltage	02h		V	-20	-90	2	-3
14	0Eh	Input Current	03h		A	20	0	0	-2
15	0Fh	iS1, +12V Current	03h		A	20	0	0	-2
16	10h	iS2, +3.3V Current	03h		A	20	0	0	-2
17	11h	iS3, +5V Current	03h		A	20	0	0	-2
18	12h	Card Edge Temp towards P6	01h		K	1	20	1	0
19	13h	Card Edge Temp towards P1	01h		K	1	20	1	0
21	15h	Input Power Consumption	0Bh		W	30	0	0	-1
22	16h	VS1, +12V Power Consumption	0Bh		W	25	0	0	-1
23	17h	VS2, +3.3V Power Consumption	0Bh		W	4	0	0	-1
24	18h	VS3, +5V Power Consumption	0Bh		W	10	0	0	-1
25	19h	iAUX2, +3.3VAUX Current	03h		A	50	0	0	-3
26	1Ah	iAUX3, +12VAUX Current	03h		A	20	0	0	-3
27	1Bh	iAUX1, -12VAUX Current	03h		A	20	0	0	-3
28	1Ch	AUX Power Consumption	0Bh		W	8	0	0	-1
33	21h	Output Power Consumption	0Bh		W	30	0	0	-1

**Table 8** — Sensor list and coefficients

## Thresholds

Upper and lower limits of the sensors are shown in Table 5. Exceeding the nonrecoverable or critical limits will trigger a system event message and set the appropriate bits in the warning sensor registers (Sensors 2, 3 and 4). They reflect a degradation of the power supply towards its operational limits but are still within operating norms.

Exceeding nonrecoverable limits of the power supply will cause the power supply to shut down all outputs except the 3.3V internal supply which powers the microcontroller and bus interface. The system will try to recover from all nonrecoverable faults after 1s shut down of all outputs.

The high non-recoverable threshold of the input voltage is set to 255h (60V) since the unit is capable of operating through MIL-STD-1275E surges. The surge protection circuit inside the power supply will limit the input voltage to be inside the units allowable range during a surge. If a surge exceeding the maximum allowable limits persists, the unit will shut down for at least 25s and attempt auto-recovery.

Sensors		Critical Thresholds				Nonrecoverable Thresholds				Hysteresis
		LOW		High		LOW		High		
#	Name	Sensor Count	Actual Value	Sensor Count	Actual Value	Sensor Count	Actual Value	Sensor Count	Actual Value	Sensor Count
7	Input Voltage	40	17V	166	42.2V	14	11.8V	255	60V	5
8	VS1, +12V Voltage	126	11.52V	174	12.48V	114	11.28V	187	12.74V	5
9	VS2, +3.3V Voltage	124	3.24V	144	3.44V	117	3.17V	148	3.48V	5
10	VS3, +5V Voltage	135	4.85V	165	5.15V	130	4.8V	170	5.2V	5
11	AUX2, +3.3VAUX Voltage	124	3.24V	144	3.44V	115	3.15V	146	3.46V	5
12	AUX3, +12VAUX Voltage	124	11.48V	174	12.48V	114	11.28V	187	12.74V	5
13	AUX1, -12VAUX Voltage	174	-12.48V	126	-11.52V	187	-12.74V	114	-11.28V	5
14	Input Current			170	34A			240	48	20
15	iS1, +12V Current			180	36A			230	46	20
16	iS2, +3.3V Current			80	16A			120	24	10
17	iS3, +5V Current			130	26A			175	35	10
18	Card Edge Temp towards P6	38	238K	158	358K	32	232K	168	368K	10
19	Card Edge Temp towards P1	38	238K	158	358K	32	232K	168	368K	10
21	Input Power Consumption			227	681W			250	750W	6
22	VS1, +12V Power Consumption			192	480W			220	550W	6
23	VS2, +3.3V Power Consumption			165	66W			195	78W	6
24	VS3, +5V Power Consumption			130	130W			172	172W	6
25	iAUX2, +3.3VAUX Current			130	6.5A			165	8.25A	5
26	iAUX3, +12VAUX Current			45	0.9A			70	1.4A	5
27	iAUX1, -12VAUX Current			45	0.9A			70	1.4A	5
28	AUX Power Consumption			123	98.4W			140	112W	5
33	Output Power			192	576W			215	645W	4

**Table 9** — Sensor thresholds

Power Architecture

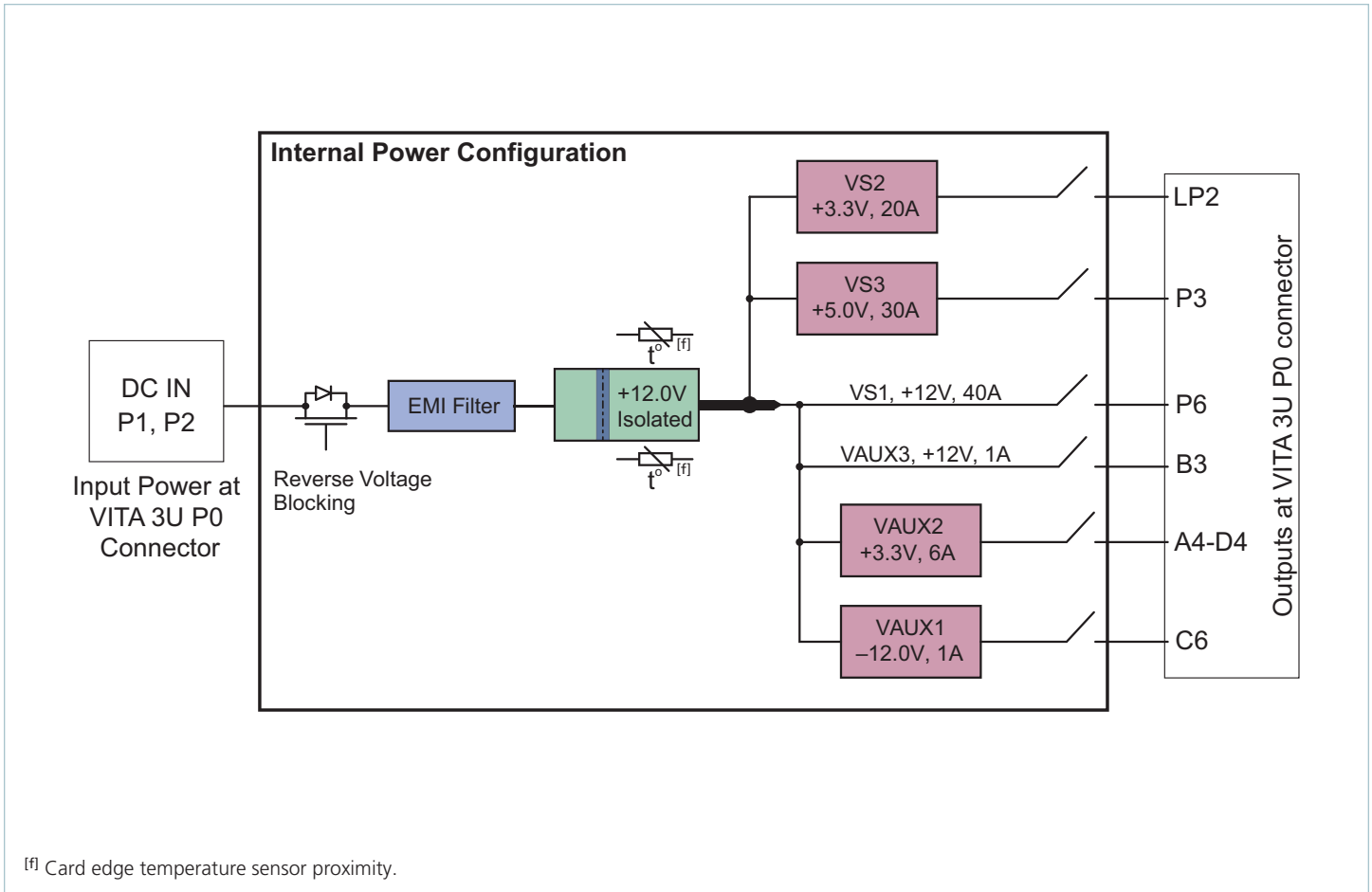

<sup>[f]</sup> Card edge temperature sensor proximity.



Mechanical Drawing

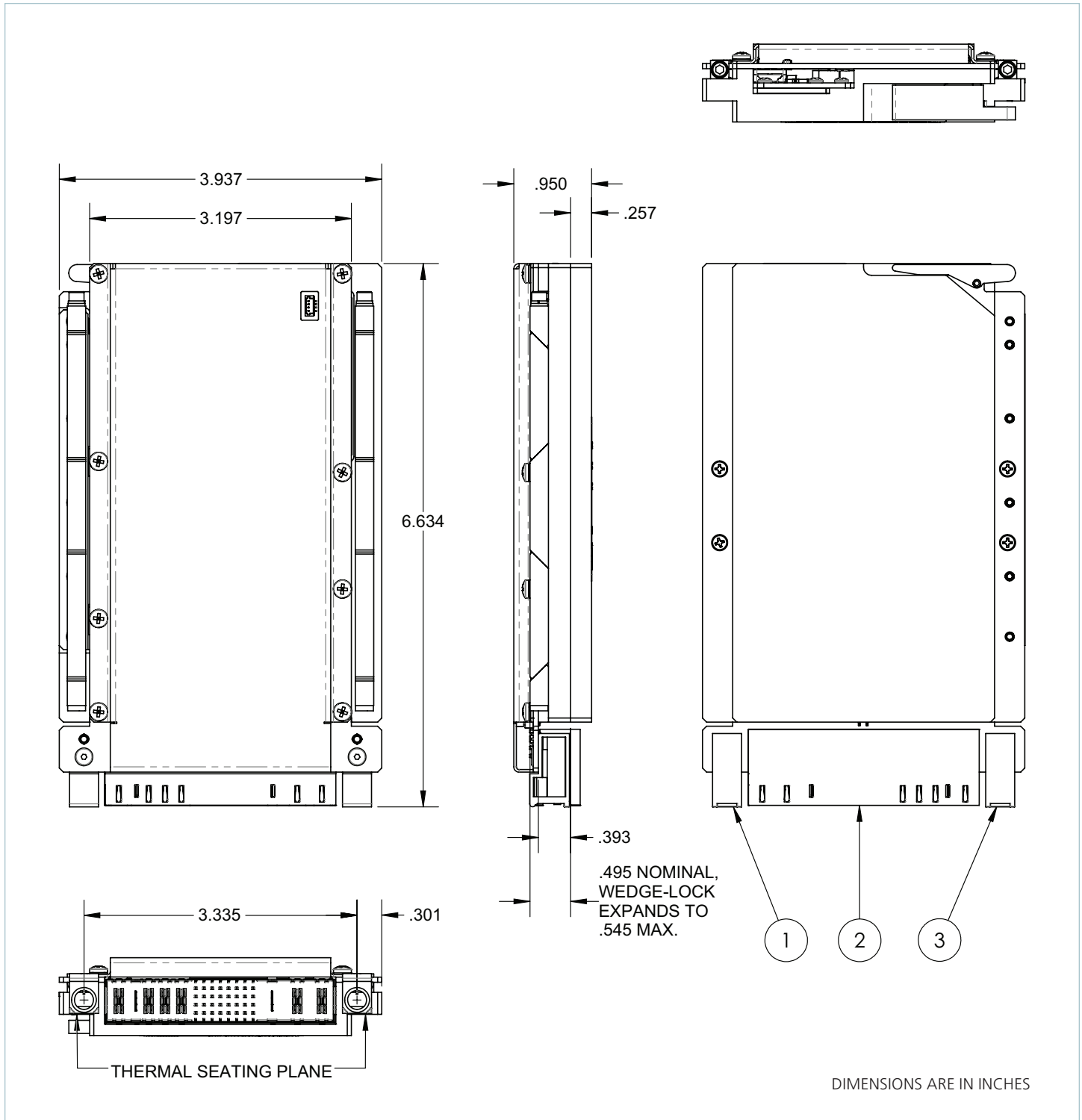

Connector Components

Item #	Description	Manufacturer	Manufacturer Part Number
1	VITA46 0 DEG Guide Socket	TE Connectivity	1-1469492-1
2	VITA62 Connector Plug	TE Connectivity	6450849-7
3	VITA46 0 DEG Guide Socket	TE Connectivity	1-1469492-1

## Revision History

Revision	Date	Description	Page Number(s)
1.0	04/14/20	Initial release	n/a
1.1	08/19/20	Added standalone operation section Updated I <sup>2</sup> C sensor commands Updated I <sup>2</sup> C information Updated IPMI information	21 24 25 – 29 30 – 31
1.2	11/23/20	Typo correction	24
1.3	08/26/21	Revised storage temperature minimum Corrected typos in table 3 Revised communication example, table 6 Corrected scaling for 0x21 Bytes 16, 17, 20, 21; corrected typo for 0x90 Byte 0 Revised status register map section Updated sensor thresholds for sensors 21, 24 – 28	4, 17 20 26 27 29 31

Note: Pages added in Rev 1.1.

Contact Us: <http://www.vicorpower.com/contact-us>

### Vicor Corporation

25 Frontage Road  
Andover, MA, USA 01810  
Tel: 800-735-6200  
Fax: 978-475-6715  
[www.vicorpower.com](http://www.vicorpower.com)

### email

Customer Service: [custserv@vicorpower.com](mailto:custserv@vicorpower.com)  
Technical Support: [apps@vicorpower.com](mailto:apps@vicorpower.com)

©2020 – 2021 Vicor Corporation. All rights reserved. The Vicor name is a registered trademark of Vicor Corporation.  
I<sup>2</sup>C™ is a trademark of NXP semiconductor.  
All other trademarks, product names, logos and brands are property of their respective owners.

## X-ON Electronics

Largest Supplier of Electrical and Electronic Components

*Click to view similar products for [Isolated DC/DC Converters](#) category:*

*Click to view products by [Vicor](#) manufacturer:*

Other Similar products are found below :

[ESM6D044440C05AAQ](#) [FMD15.24G](#) [PSL486-7LR](#) [Q48T30020-NBB0](#) [JAHW100Y1](#) [SPB05C-12](#) [SQ24S15033-PS0S](#) [18952](#) [19-130041](#)  
[CE-1003](#) [CE-1004](#) [GQ2541-7R](#) [RDS180245](#) [MAU228](#) [J80-0041NL](#) [DFC15U48D15](#) [XGS-0512](#) [XGS-1205](#) [XGS-1212](#) [XGS-2412](#) [XGS-2415](#) [XKS-1215](#) [06322](#) [NCT1000N040R050B](#) [SPB05B-15](#) [SPB05C-15](#) [L-DA20](#) [DCG40-5G](#) [QME48T40033-PGB0](#) [XKS-2415](#) [XKS-2412](#)  
[XKS-1212](#) [XKS-1205](#) [XKS-0515](#) [XKS-0505](#) [XGS-2405](#) [XGS-1215](#) [XGS-0515](#) [PS9Z-6RM4](#) [73-551-5038I](#) [AK1601-9RT](#) [VI-N61-CM](#) [VI-R5022-EXWW](#) [PSC128-7iR](#) [RPS8-350ATX-XE](#) [DAS1004812](#) [PQA30-D24-S24-DH](#) [VI-M5F-CQ](#) [VI-LN2-EW](#) [VI-PJW01-CZY](#)