



### High Efficiency, Sine Amplitude Converter™

#### Features & Benefits

- 48V<sub>DC</sub> to 48V<sub>DC</sub> 6.3A current multiplier
  - Operating from standard 48V or 24V PRM™ Regulators
- High efficiency (>96%) reduces system power consumption
- High density (21.8A/in<sup>3</sup>)
- “Full Chip” VI Chip® package enables surface mount, low impedance interconnect to system board
- Contains built-in protection features against:
  - Overvoltage Lockout
  - Overcurrent
  - Short Circuit
  - Overtemperature
- Provides enable / disable control, internal temperature monitoring
- ZVS / ZCS resonant Sine Amplitude Converter topology
- Less than 50°C temperature rise at full load in typical applications

#### Typical Applications

- High-End Computing Systems
- Automated Test Equipment
- High-Density Power Supplies
- Communications Systems

#### Typical Application

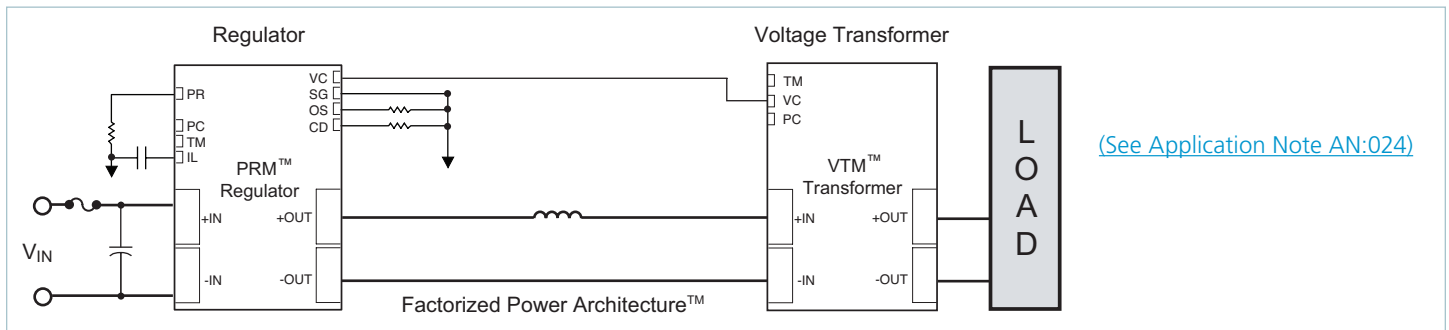

Product Ratings	
$V_{IN} = 26 - 55V$	$I_{OUT} = 6.3A$ (Nominal)
$V_{OUT} = 26 - 55V$ (No Load)	$K = 1$

#### Product Description

The VI Chip® current multiplier is a high efficiency (>96%) Sine Amplitude Converter™ (SAC) operating from a 26 to 55V<sub>DC</sub> primary bus to deliver an isolated output. The Sine Amplitude Converter offers a low AC impedance beyond the bandwidth of most downstream regulators; therefore capacitance normally at the load can be located at the input to the Sine Amplitude Converter. Since the K factor of the VTM48EF480T006A00 is 1, the capacitance value can be reduced by a factor of 1, resulting in savings of board area, materials and total system cost.

The VTM48EF480T006A00 is provided in a VI Chip package compatible with standard pick-and-place and surface mount assembly processes. The co-molded VI Chip package provides enhanced thermal management due to a large thermal interface area and superior thermal conductivity. The high conversion efficiency of the VTM48EF480T006A00 increases overall system efficiency and lowers operating costs compared to conventional approaches.

The VTM48EF480T006A00 enables the utilization of Factorized Power Architecture™ which provides efficiency and size benefits by lowering conversion and distribution losses and promoting high density point-of-load conversion.

#### Part Numbering

Product Number	Package Style (x)	Product Grade (y)
VTM48Ex480y006A00	F = J-Lead	T = -40 to 125°C
	T = Through hole	M = -55 to 125°C

For Storage and Operating Temperatures see General Characteristics Section

## Absolute Maximum Ratings

The absolute maximum ratings below are stress ratings only. Operation at or beyond these maximum ratings can cause permanent damage to the device.

Parameter	Comments	Min	Max	Unit
+IN to -IN		-1.0	60	V <sub>DC</sub>
PC to -IN		-0.3	20	V <sub>DC</sub>
TM to -IN		-0.3	7	V <sub>DC</sub>
VC to -IN		-0.3	20	V <sub>DC</sub>
+IN / -IN to +OUT / -OUT (hipot)			2250	V <sub>DC</sub>
+OUT to -OUT		-0.5	60	V <sub>DC</sub>

## Electrical Specifications

Specifications apply over all line and load conditions unless otherwise noted; **boldface** specifications apply over the temperature range of -40°C < T<sub>J</sub> < 125°C (T-Grade). All other specifications are at T<sub>J</sub> = 25°C unless otherwise noted.

Attribute	Symbol	Conditions / Notes	Min	Typ	Max	Unit
<b>Powertrain</b>						
Input Voltage Range	V <sub>IN</sub>	No external VC applied	<b>26</b>		<b>55</b>	V <sub>DC</sub>
		VC applied	<b>0</b>		<b>55</b>	
V <sub>IN</sub> Slew Rate	dV <sub>IN</sub> / dt				<b>1</b>	V / μs
V <sub>IN</sub> UV Turn Off	V <sub>IN_UV</sub>	Module latched shutdown, No external VC applied, I <sub>OUT</sub> = 6.3A		24	<b>26</b>	V
No Load Power Dissipation	P <sub>NL</sub>	V <sub>IN</sub> = 48V	<b>2.3</b>		<b>10.0</b>	W
		V <sub>IN</sub> = 26 – 55V			<b>11</b>	
		V <sub>IN</sub> = 48V, T <sub>C</sub> = 25°C		3.4	4.5	
		V <sub>IN</sub> = 26 – 55V, T <sub>C</sub> = 25°C			7	
Inrush Current Peak	I <sub>INRP</sub>	VC enable, V <sub>IN</sub> = 48V, C <sub>OUT</sub> = 100μF, R <sub>LOAD</sub> = 7443mΩ		16.5	<b>24</b>	A
DC Input Current	I <sub>IN_DC</sub>				<b>6.4</b>	A
Transfer Ratio	K	K = V <sub>OUT</sub> / V <sub>IN</sub> , I <sub>OUT</sub> = 0A		1		V / V
Output Voltage	V <sub>OUT</sub>	V <sub>OUT</sub> = V <sub>IN</sub> • K – I <sub>OUT</sub> • R <sub>OUT</sub>				V
Output Current (Average)	I <sub>OUT_AVG</sub>				<b>6.3</b>	A
Output Current (Peak)	I <sub>OUT_PK</sub>	t <sub>PEAK</sub> < 10ms, I <sub>OUT_AVG</sub> ≤ 6.3A			<b>7.9</b>	A
Output Power (Average)	P <sub>OUT_AVG</sub>	I <sub>OUT_AVG</sub> ≤ 6.3A			<b>300</b>	W
Efficiency (Ambient)	η <sub>AMB</sub>	V <sub>IN</sub> = 48V, I <sub>OUT</sub> = 6.3A	95.0	96.2		%
		V <sub>IN</sub> = 26 – 55V, I <sub>OUT</sub> = 6.3A	93.3			
		V <sub>IN</sub> = 48V, I <sub>OUT</sub> = 3.15A	95.5	96.4		
Efficiency (Hot)	η <sub>HOT</sub>	V <sub>IN</sub> = 48V, T <sub>C</sub> = 100°C, I <sub>OUT</sub> = 6.3A	94.4	95.6		%
Efficiency (Over Load Range)	η <sub>20%</sub>	1.26A < I <sub>OUT</sub> < 6.3A	<b>80.0</b>			%

## Electrical Specifications (Cont.)

Specifications apply over all line and load conditions unless otherwise noted; **boldface** specifications apply over the temperature range of  $-40^{\circ}\text{C} < T_j < 125^{\circ}\text{C}$  (T-Grade). All other specifications are at  $T_j = 25^{\circ}\text{C}$  unless otherwise noted.

Attribute	Symbol	Conditions / Notes	Min	Typ	Max	Unit
<b>Powertrain (Cont.)</b>						
Output Resistance (Cold)	$R_{\text{OUT\_COLD}}$	$T_C = -40^{\circ}\text{C}$ , $I_{\text{OUT}} = 6.3\text{A}$	98.0	133.0	170.0	m $\Omega$
Output Resistance (Ambient)	$R_{\text{OUT\_AMB}}$	$T_C = 25^{\circ}\text{C}$ , $I_{\text{OUT}} = 6.3\text{A}$	120	176.0	250.0	m $\Omega$
Output Resistance (Hot)	$R_{\text{OUT\_HOT}}$	$T_C = 100^{\circ}\text{C}$ , $I_{\text{OUT}} = 6.3\text{A}$	180.0	230.0	280.0	m $\Omega$
Switching Frequency	$F_{\text{SW}}$		<b>1.64</b>	1.67	<b>1.70</b>	MHz
Output Ripple Frequency	$F_{\text{SW\_RP}}$		<b>3.28</b>	3.34	<b>3.40</b>	MHz
Output Voltage Ripple	$V_{\text{OUT\_PP}}$	$C_{\text{OUT}} = 0\text{F}$ , $I_{\text{OUT}} = 6.3\text{A}$ , $V_{\text{IN}} = 48\text{V}$ , 20MHz BW,		360	<b>500</b>	mV
Output Inductance (Parasitic)	$L_{\text{OUT\_PAR}}$	Frequency up to 30MHz, Simulated J-lead model		600		pH
Output Capacitance (Internal)	$C_{\text{OUT\_INT}}$	Effective Value at $48V_{\text{OUT}}$		3.5		$\mu\text{F}$
<b>Protection</b>						
Overvoltage Lockout	$V_{\text{IN\_OVLO+}}$	Module latched shutdown	<b>55.1</b>	58.5	<b>60.0</b>	V
Overvoltage Lockout Response Time Constant	$t_{\text{OVLO}}$	Effective internal RC filter		8		$\mu\text{s}$
Output Overcurrent Trip	$I_{\text{OCP}}$		<b>6.4</b>	10	<b>15</b>	A
Short Circuit Protection Trip Current	$I_{\text{SCP}}$		16			A
Output Overcurrent Response Time Constant	$t_{\text{OCP}}$	Effective internal RC filter (Integrative)		3.8		ms
Short Circuit Protection Response Time	$t_{\text{SCP}}$	From detection to cessation of switching (Instantaneous)		1		$\mu\text{s}$
Thermal Shutdown Set Point	$T_{\text{J\_OTP}}$		125	130	135	$^{\circ}\text{C}$
Reverse Inrush Current Protection		Reverse Inrush protection is enabled for this product				

## Signal Characteristics

Specifications apply over all line and load conditions unless otherwise noted; **boldface** specifications apply over the temperature range of  $-40^{\circ}\text{C} \leq T_j < 125^{\circ}\text{C}$  (T-Grade). All other specifications are at  $T_j = 25^{\circ}\text{C}$  unless otherwise noted.

VTM Control: VC									
<ul style="list-style-type: none"> <li>Used to wake up powertrain circuit.</li> <li>A minimum of 11.5V must be applied indefinitely for <math>V_{IN} &lt; 26\text{V}</math> to ensure normal operation.</li> <li>VC slew rate must be within range for a successful start.</li> <li>PRM™ VC must be used as valid wake-up signal source.</li> <li>Internal Resistance used in “Adaptive Loop” compensation.</li> </ul>									
Signal Type	State	Attribute	Symbol	Conditions / Notes	Min	Typ	Max	Unit	
Analog Input	Steady	External VC Voltage	$V_{VC\_EXT}$	Required for start up and operation below 26V.	11.5		<b>16.5</b>	V	
		VC Current Draw	$I_{VC}$	VC = 11.5V, $V_{IN} = 0\text{V}$		150	<b>200</b>	mA	
				VC = 11.5V, $V_{IN} > 26\text{V}$		0			
				VC = 16.5V, $V_{IN} > 26\text{V}$		0			
				Fault mode. VC > 11.5V		60			
		VC Internal Diode Rating	$D_{VC\_INT}$			100		V	
	VC Internal Resistor	$R_{VC\_INT}$			0.51		k $\Omega$		
	VC Internal Resistor Temperature Coefficient	$T_{VC\_COEFF}$					3900	ppm/ $^{\circ}\text{C}$	
	Start Up	VC Start-Up Pulse	$V_{VC\_SP}$	$t_{PEAK} < 18\text{ms}$				20	V
		VC Slew Rate	$dVC/dt$	Required for proper start up	<b>0.05</b>		<b>0.25</b>	V / $\mu\text{s}$	
		VC Inrush Current	$I_{INR\_VC}$	VC = 16.5V, $dVC/dt = 0.25\text{V}/\mu\text{s}$			<b>2</b>	A	
Transitional	VC to $V_{OUT}$ Turn-On Delay	$t_{ON}$	$V_{IN}$ pre-applied, PC floating, VC enable, $C_{PC} = 0\mu\text{F}$				<b>500</b>	$\mu\text{s}$	
	VC to PC Delay	$t_{VC\_PC}$	VC = 11.5V to PC high, $V_{IN} = 0\text{V}$ , $dVC/dt = 0.25\text{V}/\mu\text{s}$		75	125	$\mu\text{s}$		
	Internal VC Capacitance	$C_{VC\_INT}$	VC = 0V			6.9	$\mu\text{F}$		

Primary Control: PC								
<ul style="list-style-type: none"> <li>The PC pin enables and disables the VTM module. When held below 2V, the VTM module will be disabled.</li> <li>PC pin outputs 5V during normal operation. PC pin is equal to 2.5V during fault mode given <math>V_{IN} &gt; 26\text{V}</math> or <math>VC &gt; 11.5\text{V}</math>.</li> <li>After successful start up and under no fault condition, PC can be used as a 5V regulated voltage source with a 2mA maximum current.</li> <li>Module will shutdown when pulled low with an impedance less than 400<math>\Omega</math>.</li> <li>In an array of VTM modules, connect PC pin to synchronize start up.</li> <li>PC pin cannot sink current and will not disable other modules during fault mode.</li> </ul>								
Signal Type	State	Attribute	Symbol	Conditions / Notes	Min	Typ	Max	Unit
Analog Output	Steady	PC Voltage	$V_{PC}$		<b>4.7</b>	5.0	<b>5.3</b>	V
		PC Source Current	$I_{PC\_OP}$				2	mA
		PC Resistance (Internal)	$R_{PC\_INT}$	Internal pull-down resistor	<b>50</b>	150	<b>400</b>	k $\Omega$
	Start Up	PC Source Current	$I_{PC\_EN}$		<b>50</b>	100	<b>300</b>	$\mu\text{A}$
		PC Capacitance (Internal)	$C_{PC\_INT}$				<b>0</b>	pF
		PC Resistance (External)	$R_{PC\_S}$		<b>60</b>			k $\Omega$
Digital Input / Output	Enable	PC Voltage	$V_{PC\_EN}$		<b>2</b>	2.5	<b>3</b>	V
	Disable	PC Voltage (Disable)	$V_{PC\_DIS}$				<b>2</b>	V
		PC Pull-Down Current	$I_{PC\_PD}$		<b>5.1</b>			mA
	Transitional	PC Disable Time	$t_{PC\_DIS\_t}$				5	$\mu\text{s}$
PC Fault Response Time		$t_{FR\_PC}$	From fault to PC = 2V			100	$\mu\text{s}$	

## Signal Characteristics (Cont.)

Specifications apply over all line and load conditions unless otherwise noted; **boldface** specifications apply over the temperature range of  $-40^{\circ}\text{C} \leq T_j < 125^{\circ}\text{C}$  (T-Grade). All other specifications are at  $T_j = 25^{\circ}\text{C}$  unless otherwise noted.

Temperature Monitor: TM								
<ul style="list-style-type: none"> <li>The TM pin monitors the internal temperature of the VTM controller IC within an accuracy of <math>\pm 5^{\circ}\text{C}</math>.</li> <li>Can be used as a "Power Good" flag to verify that the VTM module is operating.</li> <li>The TM pin has a room-temperature set point of 3V and approximate gain of 10mV/<math>^{\circ}\text{C}</math>.</li> <li>Output drives Temperature Shutdown comparator.</li> </ul>								
Signal Type	State	Attribute	Symbol	Conditions / Notes	Min	Typ	Max	Unit
Analog Output	Steady	TM Voltage	$V_{\text{TM\_AMB}}$	$T_j$ controller = $27^{\circ}\text{C}$	2.95	3.00	3.05	V
		TM Source Current	$I_{\text{TM}}$				<b>100</b>	$\mu\text{A}$
		TM Gain	$A_{\text{TM}}$			10		mV/ $^{\circ}\text{C}$
		TM Voltage Ripple	$V_{\text{TM\_PP}}$	$C_{\text{TM}} = 0\text{F}, V_{\text{IN}} = 48\text{V}, I_{\text{OUT}} = 6.3\text{A}$		120	<b>200</b>	mV
Digital Output (Fault Flag)	Disable	TM Voltage	$V_{\text{TM\_DIS}}$			0		V
	Transitional	TM Resistance (Internal)	$R_{\text{TM\_INT}}$	Internal pull-down resistor	<b>25</b>	40	<b>50</b>	k $\Omega$
		TM Capacitance (External)	$C_{\text{TM\_EXT}}$				<b>50</b>	pF
		TM Fault Response Time	$t_{\text{FR\_TM}}$	From fault to TM = 1.5V		10		$\mu\text{s}$

## Timing Diagram

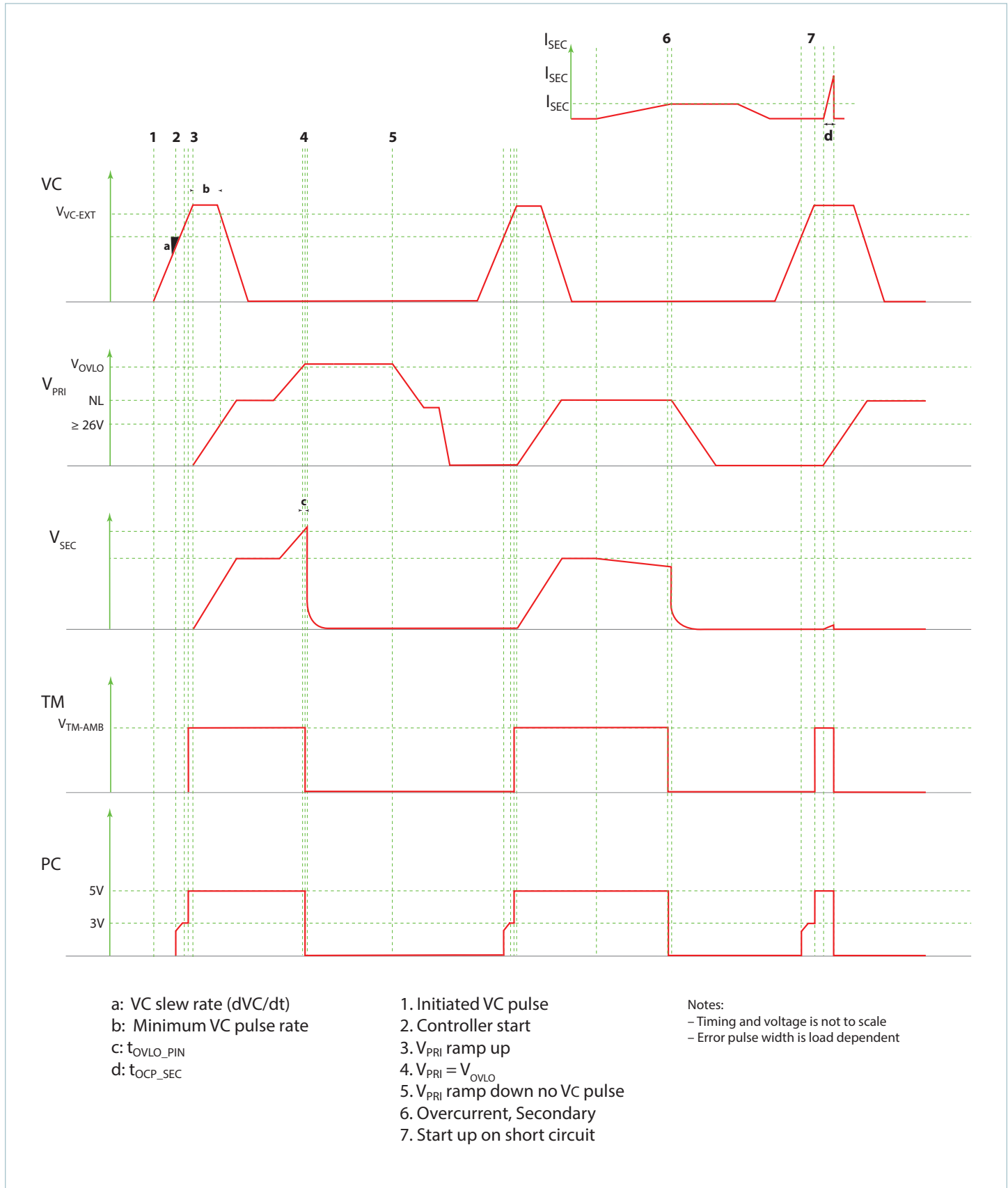

## Application Characteristics

The following values, typical of an application environment, are collected at  $T_C = 25^\circ\text{C}$  unless otherwise noted. See associated figures for general trend data.

Attribute	Symbol	Conditions / Notes	Typ	Unit
<b>Powertrain</b>				
No Load Power Dissipation	$P_{NL}$	$V_{IN} = 48\text{V}$ , PC enabled	3.2	W
Efficiency (Ambient)	$\eta_{AMB}$	$V_{IN} = 48\text{V}$ , $I_{OUT} = 6.3\text{A}$	96.0	%
Efficiency (Hot)	$\eta_{HOT}$	$V_{IN} = 48\text{V}$ , $I_{OUT} = 6.3\text{A}$ , $T_C = 100^\circ\text{C}$	95.6	%
Output Resistance (Cold)	$R_{OUT\_COLD}$	$V_{IN} = 48\text{V}$ , $I_{OUT} = 6.3\text{A}$ , $T_C = -40^\circ\text{C}$	172.6	m $\Omega$
Output Resistance (Ambient)	$R_{OUT\_AMB}$	$V_{IN} = 48\text{V}$ , $I_{OUT} = 6.3\text{A}$	241.1	m $\Omega$
Output Resistance (Hot)	$R_{OUT\_HOT}$	$V_{IN} = 48\text{V}$ , $I_{OUT} = 6.3\text{A}$ , $T_C = 100^\circ\text{C}$	282.0	m $\Omega$
Output Voltage Ripple	$V_{OUT\_PP}$	$C_{OUT} = 0\text{F}$ , $I_{OUT} = 6.3\text{A}$ , $V_{IN} = 48\text{V}$ , 20MHz BW	257	mV
$V_{OUT}$ Transient (Positive)	$V_{OUT\_TRAN+}$	$I_{OUT\_STEP} = 0 - 6.3\text{A}$ , $V_{IN} = 48\text{V}$ , $I_{SLEW} = 19\text{A}/\mu\text{s}$	2300	mV
$V_{OUT}$ Transient (Negative)	$V_{OUT\_TRAN-}$	$I_{OUT\_STEP} = 6.3 - 0\text{A}$ , $V_{IN} = 48\text{V}$ , $I_{SLEW} = 85\text{A}/\mu\text{s}$	2300	mV

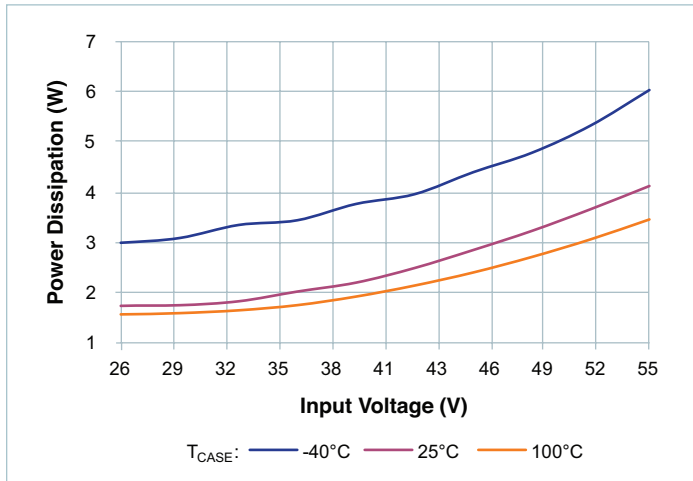

Figure 1 — No load power dissipation vs.  $V_{IN}$

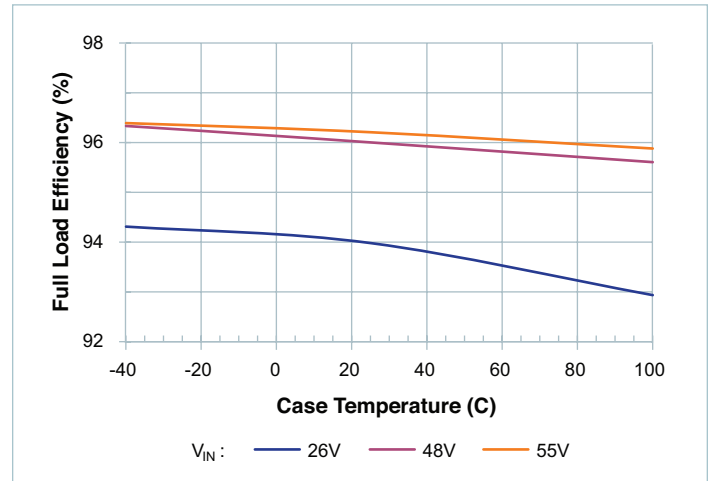

Figure 2 — Full load efficiency vs. temperature

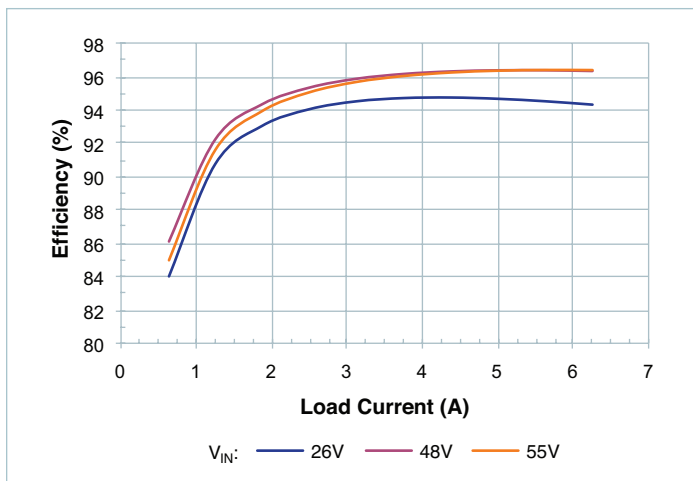

Figure 3 — Efficiency at  $-40^\circ\text{C}$

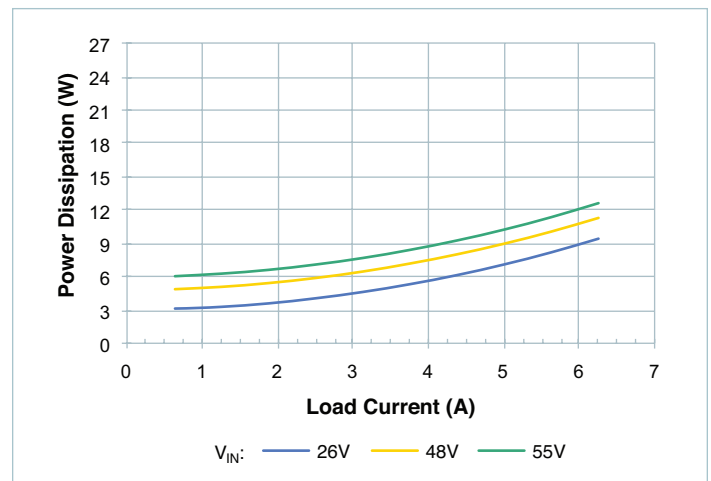

Figure 4 — Power dissipation at  $-40^\circ\text{C}$

## Application Characteristics

The following values, typical of an application environment, are collected at  $T_C = 25^\circ\text{C}$  unless otherwise noted. See associated figures for general trend data.

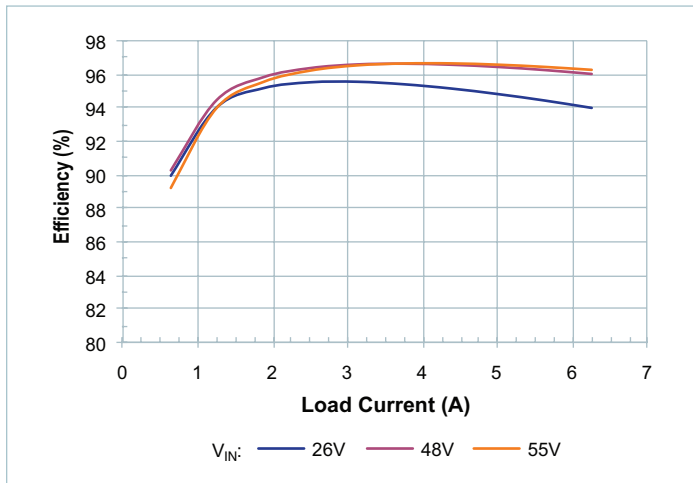

Figure 5 — Efficiency at 25°C

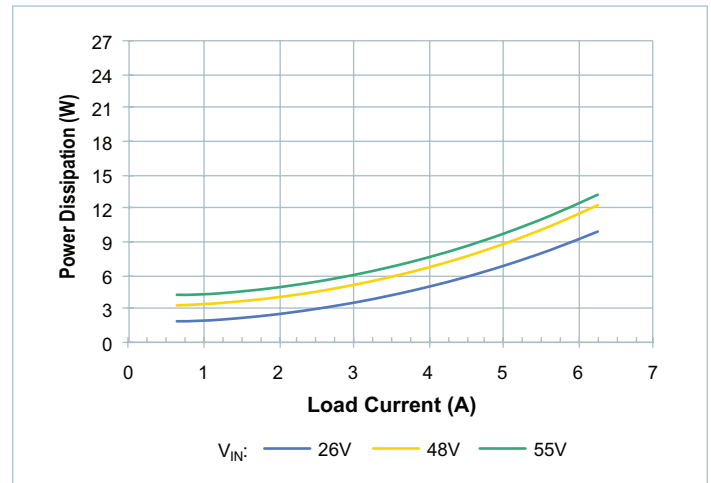

Figure 6 — Power dissipation at 25°C

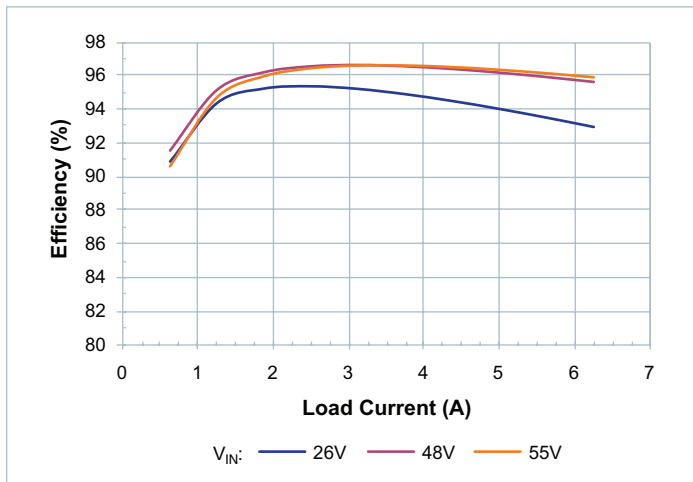

Figure 7 — Efficiency at 100°C

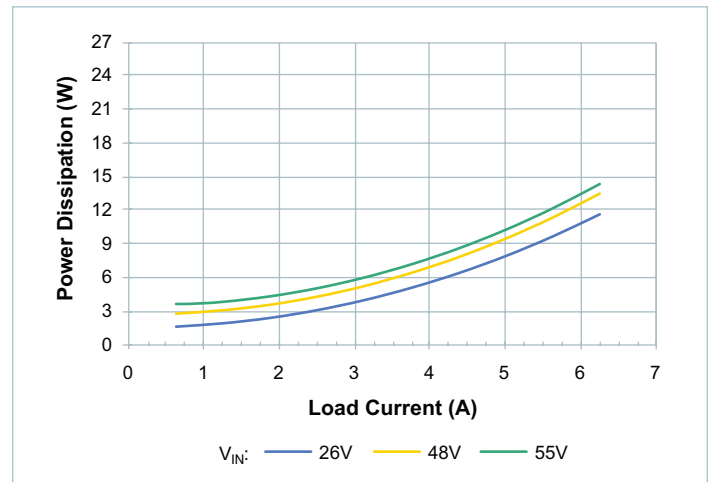

Figure 8 — Power dissipation at 100°C

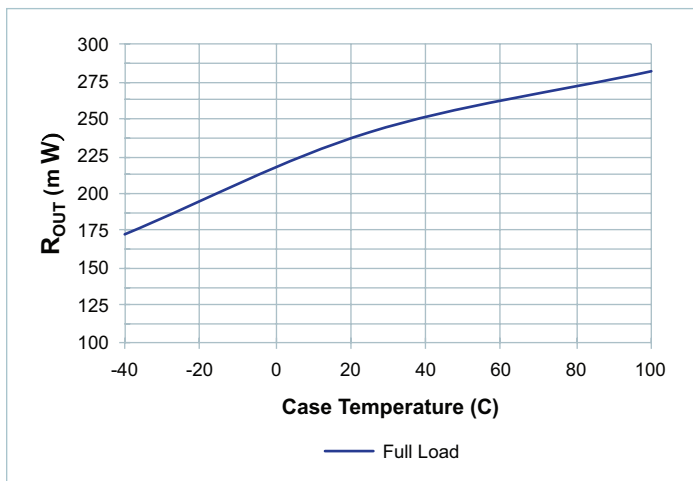

Figure 9 —  $R_{OUT}$  vs. temperature

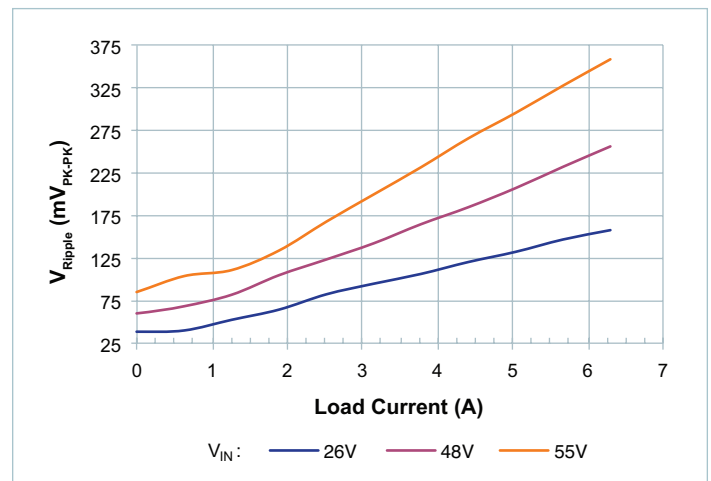

Figure 10 —  $V_{RIPPLE}$  vs.  $I_{OUT}$ ; No external  $C_{OUT}$ . Board mounted module, scope setting: 20MHz analog BW



## Application Characteristics

The following values, typical of an application environment, are collected at  $T_C = 25^\circ\text{C}$  unless otherwise noted. See associated figures for general trend data.

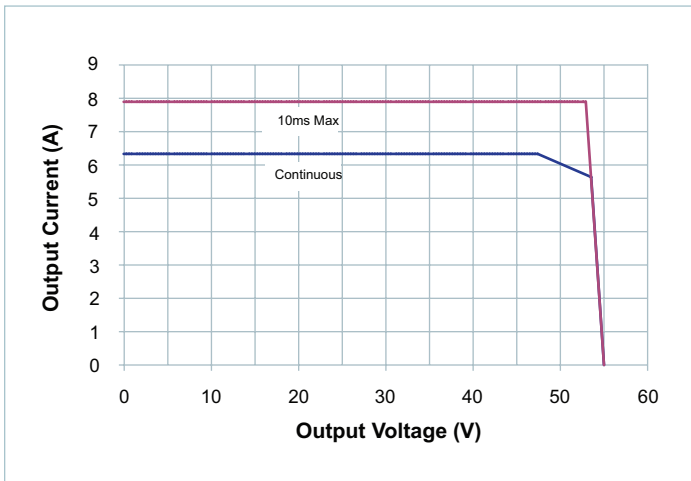

Figure 11 — Safe operating area

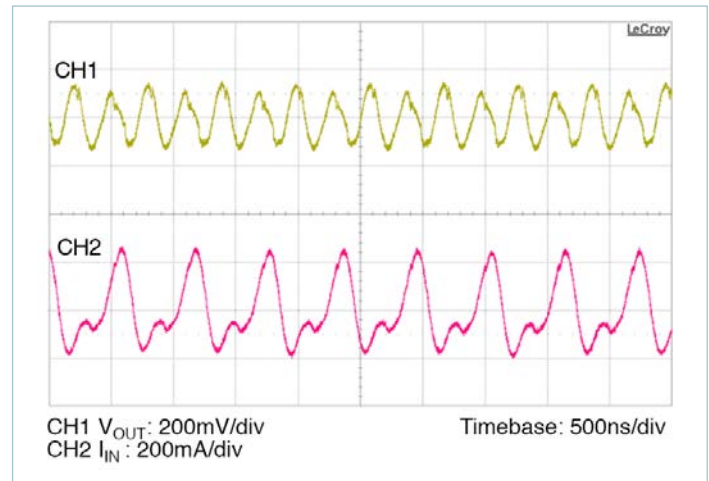

Figure 12 — Full load ripple,  $100\mu\text{F}$   $C_{IN}$ ; No external  $C_{OUT}$ . Board mounted module, scope setting: 20MHz analog BW

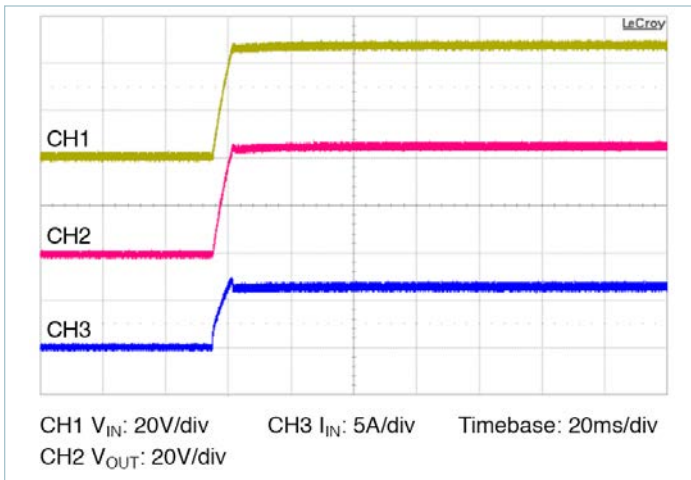

Figure 13 — Start up from application of  $V_{IN}$ ; VC pre-applied  $C_{OUT} = 100\mu\text{F}$

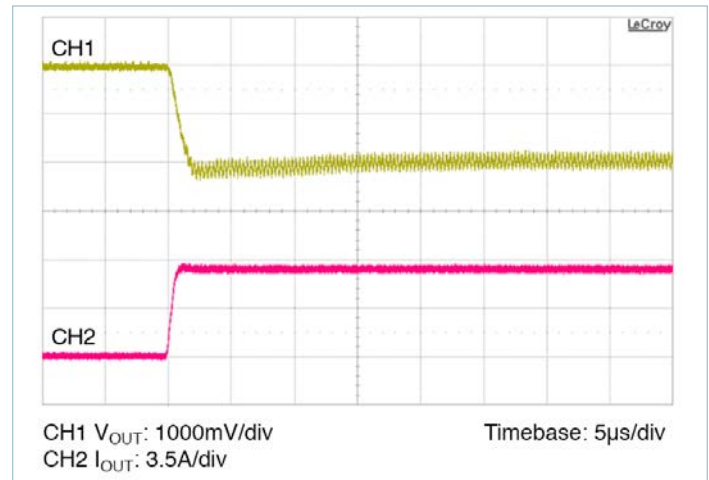

Figure 14 — 0A – Full load transient response:  $C_{IN} = 100\mu\text{F}$ , no external  $C_{OUT}$

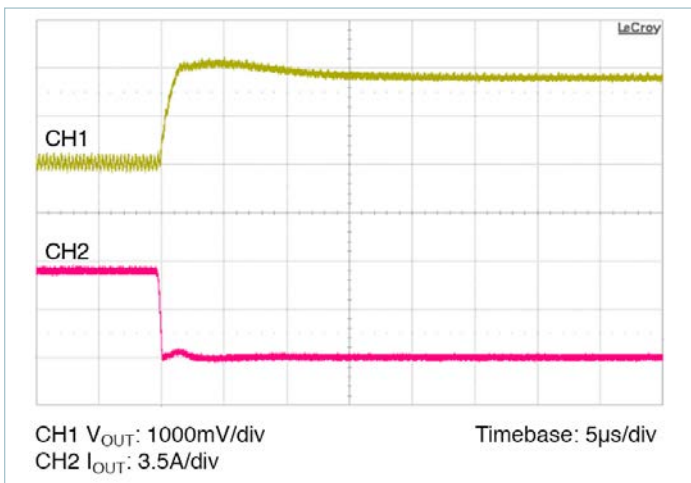

Figure 15 — Full load - 0A transient response:  $C_{IN} = 100\mu\text{F}$ , no external  $C_{OUT}$

## General Characteristics

Specifications apply over all line and load conditions unless otherwise noted; **boldface** specifications apply over the temperature range of  $-40^{\circ}\text{C} < T_j < 125^{\circ}\text{C}$  (T-Grade). All Other specifications are at  $T_j = 25^{\circ}\text{C}$  unless otherwise noted.

Attribute	Symbol	Conditions / Notes	Min	Typ	Max	Unit
<b>Mechanical</b>						
Length	L		32.25 [1.270]	32.5 [1.280]	32.75 [1.289]	mm [in]
Width	W		21.75 [0.856]	22.0 [0.866]	22.25 [0.876]	mm [in]
Height	H		6.48 [0.255]	6.73 [0.265]	6.98 [0.275]	mm [in]
Volume	Vol	No heat sink		4.81 [0.294]		cm <sup>3</sup> [in <sup>3</sup> ]
Weight	W			15.0 [0.53]		g [oz]
Lead Finish		Nickel	0.51		2.03	μm
		Palladium	0.02		0.15	
		Gold	0.003		0.051	
<b>Thermal</b>						
Operating Temperature	T <sub>J</sub>	VTM48EF480T006A00 (T-Grade)	-40		125	°C
		VTM48EF480M006A00 (M-Grade)	-55		125	
		VTM48ET480T006A00 (T-Grade)	-40		125	
		VTM48ET480M006A00 (M-Grade)	-55		125	
Thermal Resistance	θ <sub>JC</sub>	Isothermal heat sink and isothermal internal PCB		1		°C / W
Thermal Capacity				5		Ws / °C
<b>Assembly</b>						
Peak Compressive Force Applied to Case (Z-Axis)		Supported by J-Lead only			6	lbs
					5.41	lbs / in <sup>2</sup>
Storage Temperature	T <sub>ST</sub>	VTM48EF480T006A00 (T-Grade)	-40		125	°C
		VTM48EF480M006A00 (M-Grade)	-65		125	
		VTM48ET480T006A00 (T-Grade)	-40		125	
		VTM48ET480M006A00 (M-Grade)	-65		125	
ESD Withstand	ESD <sub>HBM</sub>	Human Body Model, JEDEC JESD 22-A114-F	1000			V <sub>DC</sub>
	ESD <sub>CDM</sub>	Charge Device Model, JEDEC JESD 22-C101-D	400			
<b>Soldering</b>						
Peak Temperature During Reflow		RoHS			245	°C
		Non-RoHS			225	
Peak Time Above Liquidus		Requires AN:009 compliance	60		90	s
Peak Heating Rate During Reflow		Requires AN:009 compliance	1	1.5	3	°C / s
Peak Cooling Rate Post Reflow		Requires AN:009 compliance	1	1.5	6	°C / s
<b>Safety</b>						
Isolation Voltage (Hipot)	V <sub>HIPOUT</sub>		<b>2250</b>			V <sub>DC</sub>
Isolation Capacitance	C <sub>IN_OUT</sub>	Unpowered unit	<b>2500</b>	3200	<b>3800</b>	pF
Isolation Resistance	R <sub>IN_OUT</sub>		<b>10</b>			MΩ
MTBF		MIL-HDBK-217 Plus Parts Count; 25°C Ground Benign, Stationary, Indoors / Computer Profile		3.8		MHrs
		Telcordia Issue 2 - Method I Case 1; Ground Benign, Controlled		5.6		MHrs
Agency Approvals / Standards		cTÜVus				
		CE Marked for Low Voltage Directive and RoHS Recast Directive, as applicable				

## Using the Control Signals VC, PC, TM

The **VTM Control (VC)** pin is an input pin which powers the internal VCC circuitry when within the specified voltage range of 11.5 – 16.5V. This voltage is required for VTM current multiplier start up and must be applied as long as the input is below 26V. In order to ensure a proper start, the slew rate of the applied voltage must be within the specified range.

Some additional notes on the using the VC pin:

- The VTM module will be powered by an upstream PRM™ regulator which provides a 10ms VC pulse during start up. The VC pins of the PRM regulator and VTM current multiplier should be tied together.
- The fault response of the VTM module is latching. A positive edge on VC is required in order to restart the unit.

**Primary Control (PC)** pin can be used to accomplish the following functions:

- **Delayed start:** Upon the application of VC, the PC pin will source a constant 100µA current to the internal RC network. Adding an external capacitor will allow further delay in reaching the 2.5V threshold for module start.
- **Auxiliary voltage source:** Once enabled in regular operational conditions (no fault), each VTM PC provides a regulated 5V, 2mA voltage source.
- **Output disable:** PC pin can be actively pulled down in order to disable the module. Pull-down impedance shall be lower than 400Ω.
- **Fault detection flag:** The PC 5V voltage source is internally turned off as soon as a fault is detected. It is important to notice that PC doesn't have current sink capability. Therefore, in an array, PC line will not be capable of disabling neighboring modules if a fault is detected.

**Temperature Monitor (TM)** pin provides a voltage proportional to the absolute temperature of the converter control IC.

It can be used to accomplish the following functions:

- **Monitor the control IC temperature:** The temperature in Kelvin is equal to the voltage on the TM pin scaled by 100. (i.e., 3.0V = 300K = 27°C). If a heat sink is applied, TM can be used to thermally protect the system.
- **Fault detection flag:** The TM voltage source is internally turned off as soon as a fault is detected. For system monitoring purposes (microcontroller interface) faults are detected on falling edges of TM signal.

## Start-Up Behavior

Depending on the sequencing of the VC with respect to the input voltage, the behavior during start up will vary as follows:

- **Normal operation (VC applied prior to  $V_{IN}$ ):** In this case the controller is active prior to ramping the input. When the input voltage is applied, the VTM module output voltage will track the input (See Figure 13). The inrush current is determined by the input voltage rate of rise and output capacitance. If the VC voltage is removed prior to the input reaching 26V, the VTM may shut down.

## Thermal Considerations

VI Chip® products are multi-chip modules whose temperature distribution varies greatly for each part number as well as with the input / output conditions, thermal management and environmental conditions. Maintaining the top of the VTM48EF480T006A00 case to less than 100°C will keep all junctions within the VI Chip module below 125°C for most applications.

The percent of total heat dissipated through the top surface versus through the J-lead is entirely dependent on the particular mechanical and thermal environment. The heat dissipated through the top surface is typically 60%. The heat dissipated through the J-lead onto the PCB board surface is typically 40%. Use 100% top surface dissipation when designing for a conservative cooling solution.

It is not recommended to use a VI Chip module for an extended period of time at full load without proper heat sinking.

### Sine Amplitude Converter™ Point-of-Load Conversion

The Sine Amplitude Converter (SAC) uses a high-frequency resonant tank to move energy from input to output. (The resonant tank is formed by Cr and leakage inductance Lr in the power transformer windings.) The resonant LC tank, operated at high frequency, is amplitude modulated as a function of input voltage and output current. A small amount of capacitance embedded

in the input and output stages of the module is sufficient for full functionality and is key to achieving power density.

The VTM48EF480T006A00 SAC can be simplified into the following model:

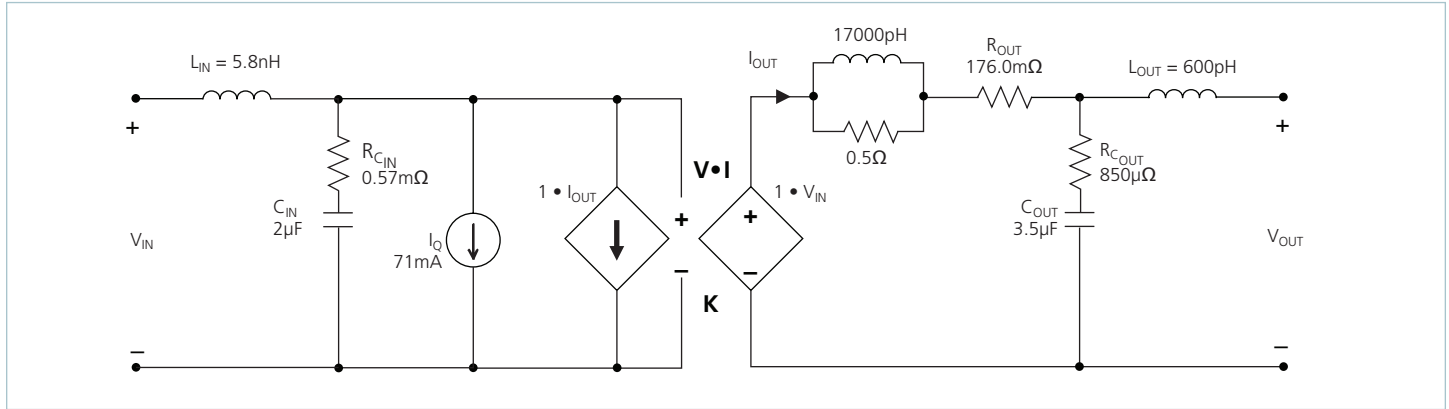

Figure 16 — VI Chip® module AC model

At no load:

$$V_{OUT} = V_{IN} \cdot K \tag{1}$$

K represents the “turns ratio” of the SAC.  
Rearranging Equation 1:

$$K = \frac{V_{OUT}}{V_{IN}} \tag{2}$$

In the presence of load, V<sub>OUT</sub> is represented by:

$$V_{OUT} = V_{IN} \cdot K - I_{OUT} \cdot R_{OUT} \tag{3}$$

and I<sub>OUT</sub> is represented by:

$$I_{OUT} = \frac{I_{IN} - I_Q}{K} \tag{4}$$

R<sub>OUT</sub> represents the impedance of the SAC, and is a function of the R<sub>DS(ON)</sub> of the input and output MOSFETs and the winding resistance of the power transformer. I<sub>Q</sub> represents the quiescent current of the SAC control and gate drive circuitry.

The use of DC voltage transformation provides additional interesting attributes. Assuming that R<sub>OUT</sub> = 0Ω and I<sub>Q</sub> = 0A, Equation 3 now becomes Equation 1 and is essentially load independent, resistor R is now placed in series with V<sub>IN</sub> as shown in Figure 17.

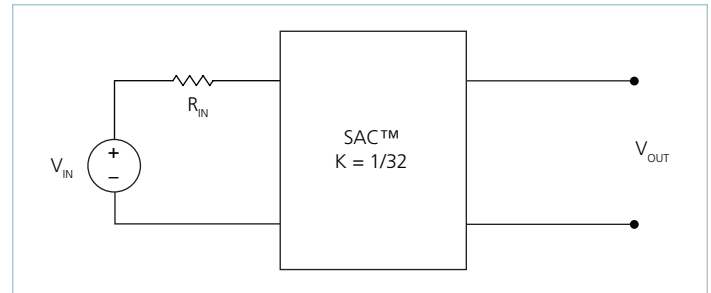

Figure 17 — K = 1/32 Sine Amplitude Converter™ with series input resistor

The relationship between V<sub>IN</sub> and V<sub>OUT</sub> becomes:

$$V_{OUT} = (V_{IN} - I_{IN} \cdot R) \cdot K \tag{5}$$

Substituting the simplified version of Equation 4 (I<sub>Q</sub> is assumed = 0A) into Equation 5 yields:

$$V_{OUT} = V_{IN} \cdot K - I_{OUT} \cdot R \cdot K^2 \tag{6}$$

This is similar in form to Equation 3, where  $R_{OUT}$  is used to represent the characteristic impedance of the SAC™. However, in this case a real R on the input side of the SAC is effectively scaled by  $K^2$  with respect to the output.

Assuming that  $R = 1\Omega$ , the effective R as seen from the secondary side is  $0.98m\Omega$ , with  $K = 1/32$  as shown in Figure 17.

A similar exercise should be performed with the addition of a capacitor or shunt impedance at the input to the SAC. A switch in series with  $V_{IN}$  is added to the circuit. This is depicted in Figure 18.

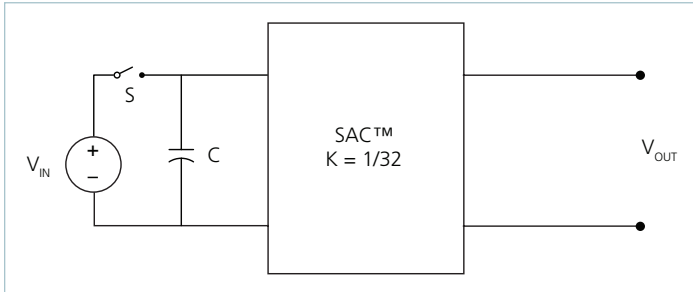

**Figure 18** — Sine Amplitude Converter™ with input capacitor

A change in  $V_{IN}$  with the switch closed would result in a change in capacitor current according to the following equation:

$$I_C(t) = C \frac{dV_{IN}}{dt} \quad (7)$$

Assume that with the capacitor charged to  $V_{IN}$ , the switch is opened and the capacitor is discharged through the idealized SAC. In this case,

$$I_C = I_{OUT} \cdot K \quad (8)$$

Substituting Equations 1 and 8 into Equation 7 reveals:

$$I_{OUT} = \frac{C}{K^2} \cdot \frac{dV_{OUT}}{dt} \quad (9)$$

The equation in terms of the output has yielded a  $K^2$  scaling factor for C, specified in the denominator of the equation. A K factor less than unity results in an effectively larger capacitance on the output when expressed in terms of the input. With a  $K = 1/32$  as shown in Figure 18,  $C = 1\mu F$  would appear as  $C = 1024\mu F$  when viewed from the output.

Low impedance is a key requirement for powering a high-current, low-voltage load efficiently. A switching regulation stage should have minimal impedance while simultaneously providing appropriate filtering for any switched current. The use of a SAC between the regulation stage and the point-of-load provides a dual benefit of scaling down series impedance leading back to the source and scaling up shunt capacitance or energy storage as a function of its K factor squared. However, the benefits are not useful if the series impedance of the SAC is too high. The impedance of the SAC must be low, i.e., well beyond the crossover frequency of the system.

A solution for keeping the impedance of the SAC low involves switching at a high frequency. This enables small magnetic components because magnetizing currents remain low. Small magnetics mean small path lengths for turns. Use of low-loss core material at high frequencies also reduces core losses.

The two main terms of power loss in the VTM module are:

- No load power dissipation ( $P_{NL}$ ): defined as the power used to power up the module with an enabled powertrain at no load.
- Resistive loss ( $R_{OUT}$ ): refers to the power loss across the VTM modeled as pure resistive impedance.

$$P_{DISSIPATED} = P_{NL} + P_{ROUT} \quad (10)$$

Therefore,

$$P_{OUT} = P_{IN} - P_{DISSIPATED} = P_{IN} - P_{NL} - P_{ROUT} \quad (11)$$

The above relations can be combined to calculate the overall module efficiency:

$$\eta = \frac{P_{OUT}}{P_{IN}} = \frac{P_{IN} - P_{NL} - P_{ROUT}}{P_{IN}} \quad (12)$$

$$\begin{aligned} &= \frac{V_{IN} \cdot I_{IN} - P_{NL} - (I_{OUT})^2 \cdot R_{OUT}}{V_{IN} \cdot I_{IN}} \\ &= 1 - \left( \frac{P_{NL} + (I_{OUT})^2 \cdot R_{OUT}}{V_{IN} \cdot I_{IN}} \right) \end{aligned}$$

## Input and Output Filter Design

A major advantage of a SAC system versus a conventional PWM converter is that the former does not require large functional filters. The resonant LC tank, operated at extreme high frequency, is amplitude modulated as a function of input voltage and output current and efficiently transfers charge through the isolation transformer. A small amount of capacitance embedded in the input and output stages of the module is sufficient for full functionality and is key to achieving high power density.

This paradigm shift requires system design to carefully evaluate external filters in order to:

- **Guarantee low source impedance:**

To take full advantage of the VTM module dynamic response, the impedance presented to its input terminals must be low from DC to approximately 5MHz. Input capacitance may be added to improve transient performance or compensate for high source impedance.

- **Further reduce input and/or output voltage ripple without sacrificing dynamic response:**

Given the wide bandwidth of the VTM module, the source response is generally the limiting factor in the overall system response. Anomalies in the response of the source will appear at the output of the VTM module multiplied by its K factor.

- **Protect the module from overvoltage transients imposed by the system that would exceed maximum ratings and cause failures:**

The VI Chip® module input/output voltage ranges must not be exceeded. An internal overvoltage lockout function prevents operation outside of the normal operating input range. Even during this condition, the powertrain is exposed to the applied voltage and power MOSFETs must withstand it.

## Capacitive Filtering Considerations for a Sine Amplitude Converter™

It is important to consider the impact of adding input and output capacitance to a Sine Amplitude Converter on the system as a whole. Both the capacitance value and the effective impedance of the capacitor must be considered.

A Sine Amplitude Converter has a DC  $R_{OUT}$  value which has already been discussed on Page 12. The AC  $R_{OUT}$  of the SAC contains several terms:

- Resonant tank impedance
- Input lead inductance and internal capacitance
- Output lead inductance and internal capacitance

The values of these terms are shown in the behavioral model on Page 12. It is important to note on which side of the transformer these impedances appear and how they reflect across the transformer given the K factor.

The overall AC impedance varies from model to model. For most models it is dominated by DC  $R_{OUT}$  value from DC to beyond 500kHz. The behavioral model on Page 12 should be used to approximate the AC impedance of the specific model.

Any capacitors placed at the output of the VTM module reflect back to the input of the module by the square of the K factor (Equation 9) with the impedance of the module appearing in series. It is very important to keep this in mind when using a PRM™ regulator to power the VTM module. Most PRM modules have a limit on the maximum amount of capacitance that can be applied to the output. This capacitance includes both the PRM output capacitance and the VTM module output capacitance reflected back to the input. In PRM module remote-sense applications, it is important to consider the reflected value of VTM module output capacitance when designing and compensating the PRM module control loop.

Capacitance placed at the input of the VTM module appear to the load reflected by the K factor with the impedance of the VTM module in series. In step-down ratios, the effective capacitance is increased by the K factor. The effective ESR of the capacitor is decreased by the square of the K factor, but the impedance of the module appears in series. Still, in most step-down VTM modules an electrolytic capacitor placed at the input of the module will have a lower effective impedance compared to an electrolytic capacitor placed at the output. This is important to consider when placing capacitors at the output of the module. Even though the capacitor may be placed at the output, the majority of the AC current will be sourced from the lower impedance, which in most cases will be the module. This should be studied carefully in any system design using a module. In most cases, it should be clear that electrolytic output capacitors are not necessary to design a stable, well-bypassed system.

## Current Sharing

The SAC™ topology bases its performance on efficient transfer of energy through a transformer without the need of closed loop control. For this reason, the transfer characteristic can be approximated by an ideal transformer with some resistive drop and positive temperature coefficient.

This type of characteristic is close to the impedance characteristic of a DC power distribution system, both in behavior (AC dynamic) and absolute value (DC dynamic).

When connected in an array with the same K factor, the VTM module will inherently share the load current (typically 5%) with parallel units according to the equivalent impedance divider that the system implements from the power source to the point of load.

Some general recommendations to achieve matched array impedances:

- Dedicate common copper planes within the PCB to deliver and return the current to the modules.
- Provide the PCB layout as symmetric as possible.
- Apply same input / output filters (if present) to each unit.

For further details see:

[AN:016 Using BCM® Bus Converters in High Power Arrays.](#)

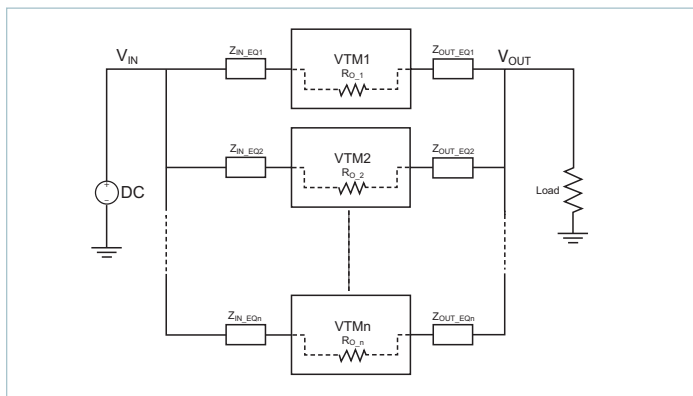

Figure 19 — VTM module array

## Fuse Selection

In order to provide flexibility in configuring power systems VI Chip® products are not internally fused. Input line fusing of VI Chip products is recommended at system level to provide thermal protection in case of catastrophic failure.

The fuse shall be selected by closely matching system requirements with the following characteristics:

- Current rating  
(usually greater than maximum current of VTM module)
- Maximum voltage rating  
(usually greater than the maximum possible input voltage)
- Ambient temperature
- Nominal melting  $I^2t$

## Reverse Operation

The VTM48EF480T006A00 is capable of reverse operation. If a voltage is present at the output which satisfies the condition  $V_{OUT} > V_{IN} \cdot K$  at the time the VC voltage is applied, or after the unit has started, then energy will be transferred from secondary to primary. The input-to-output ratio will be maintained. The VTM48EF480T006A00 will continue to operate in reverse as long as the input and output are within the specified limits. The VTM48EF480T006A00 has not been qualified for continuous operation (>10ms) in the reverse direction.

J-Lead Package Mechanical Drawing

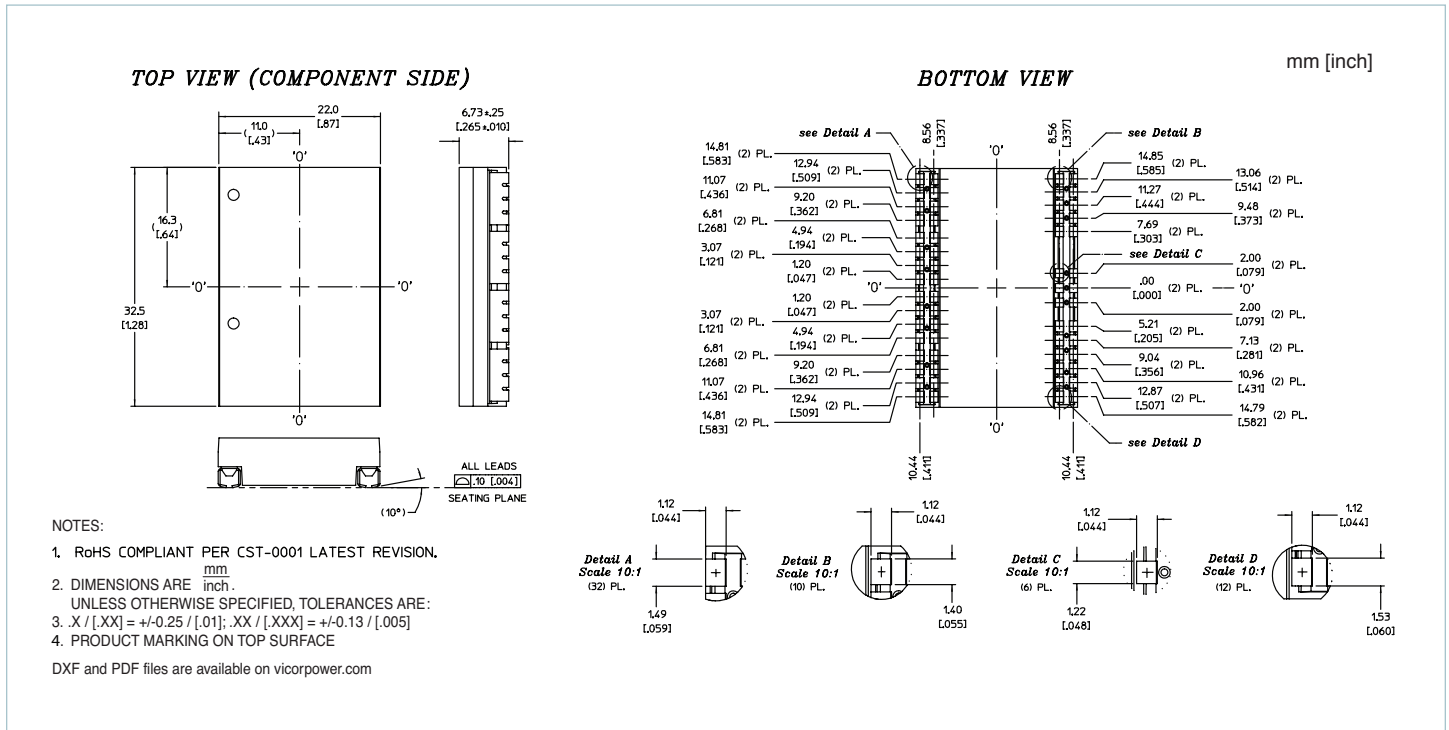

J-Lead Package Recommended Land Pattern

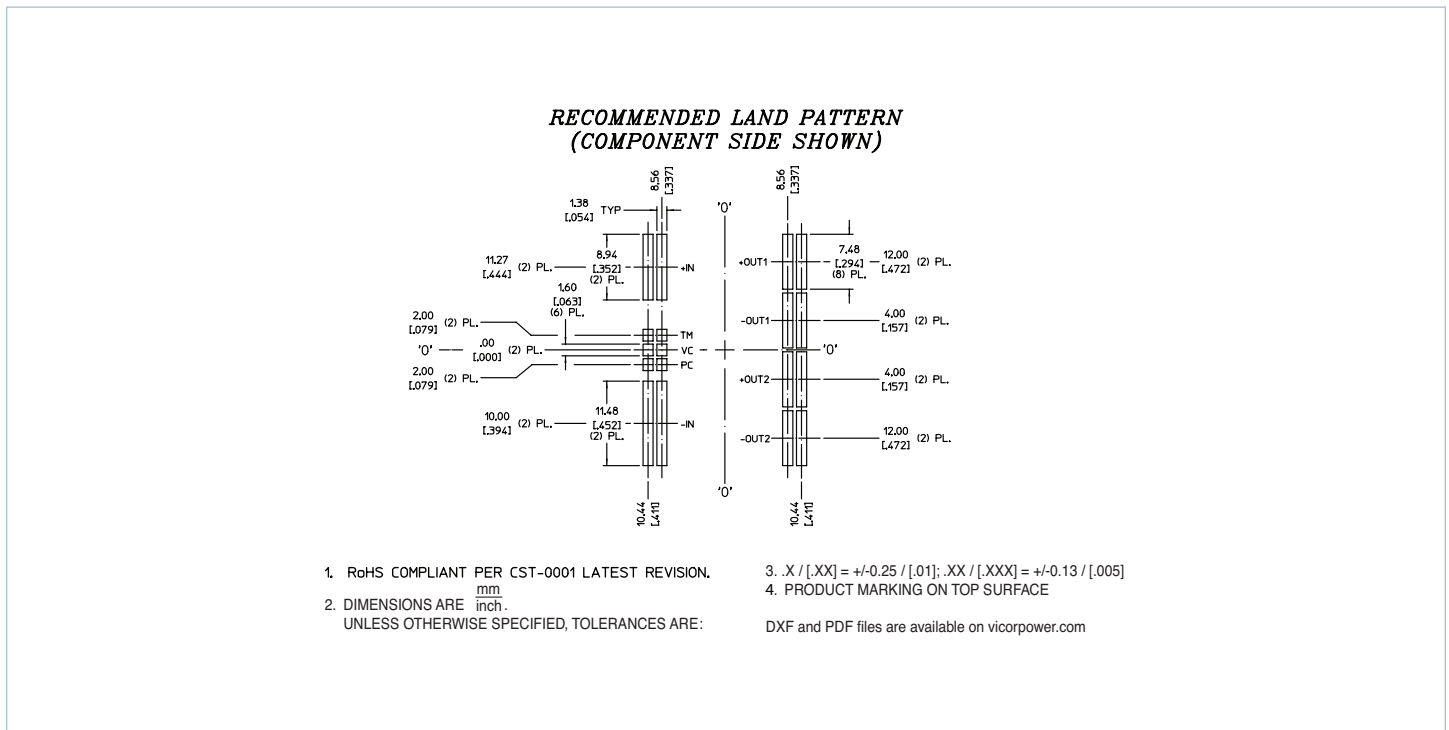



Through-Hole Package Mechanical Drawing

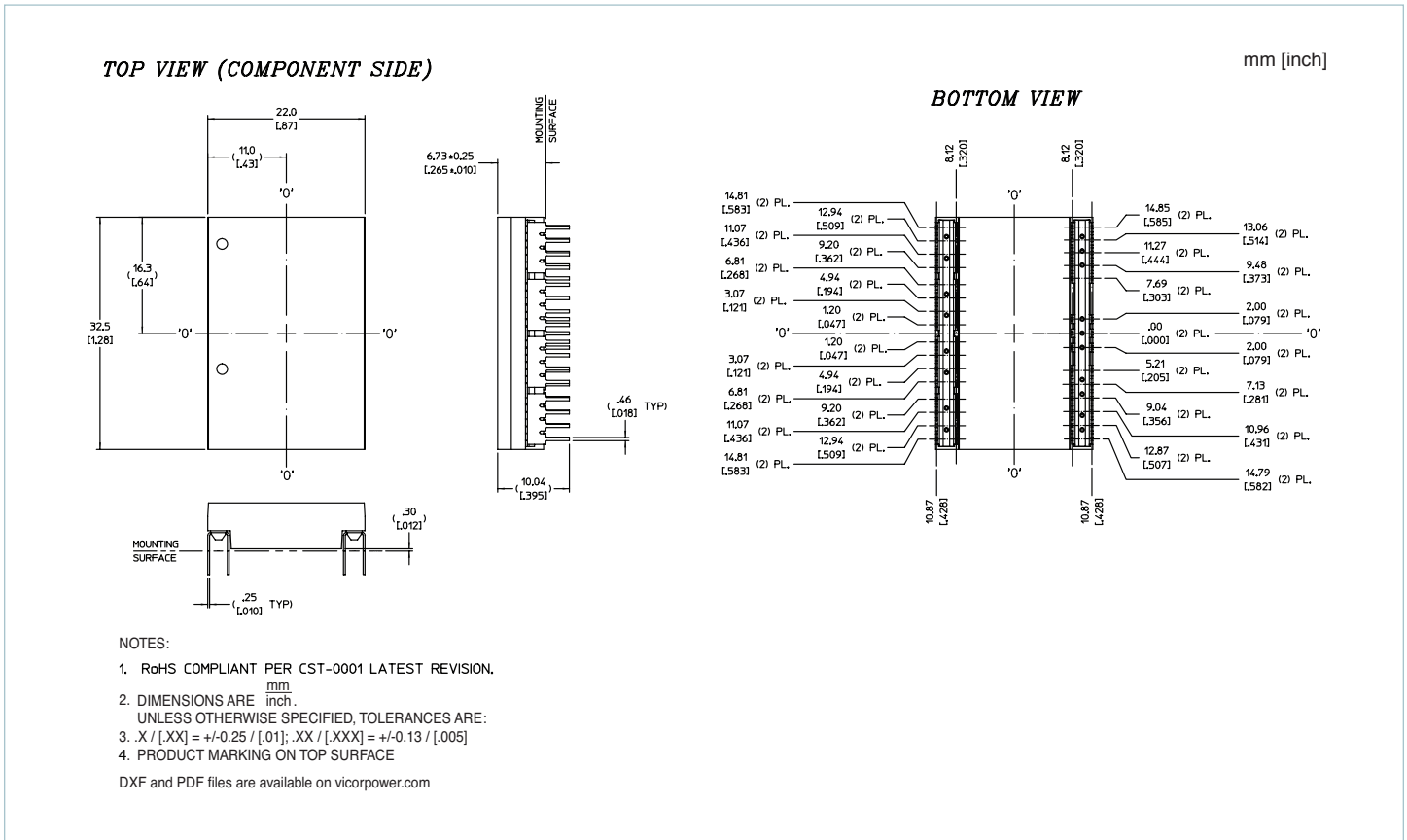

Through-Hole Package Recommended Land Pattern

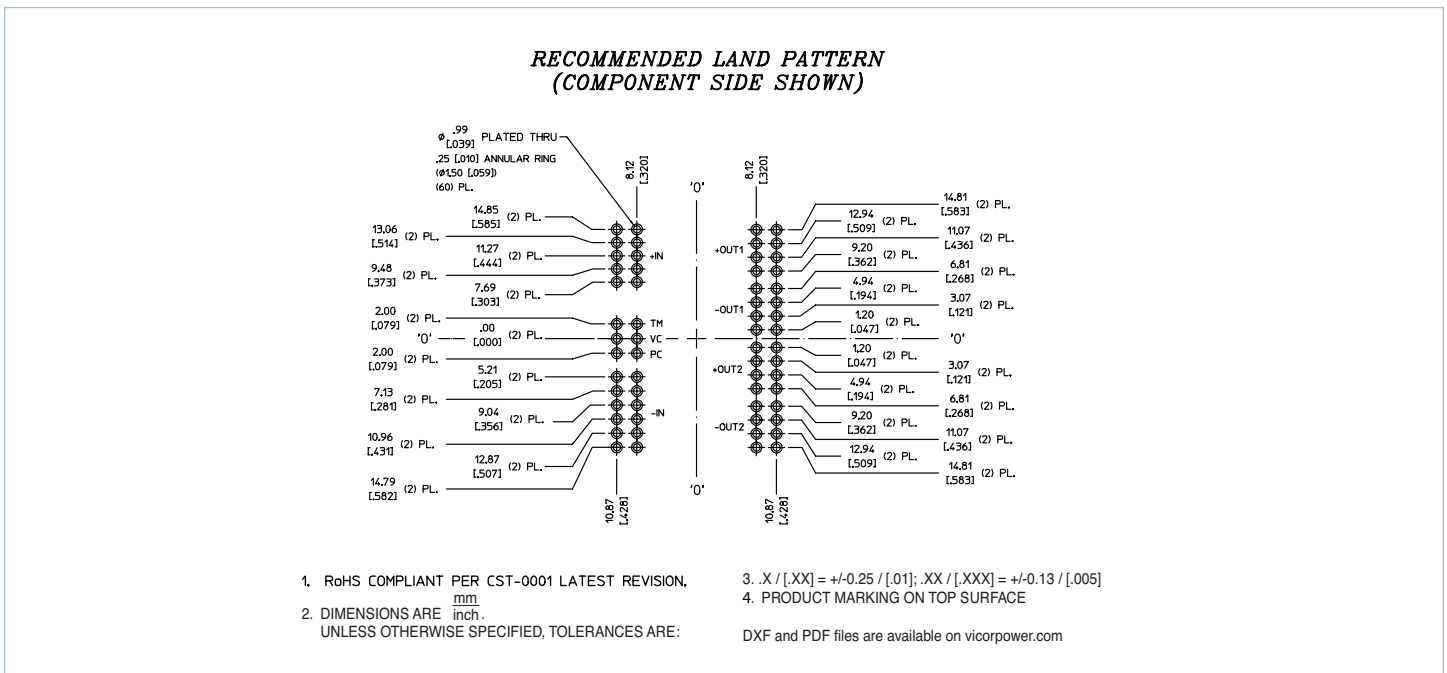

## Recommended Heat Sink Push Pin Location

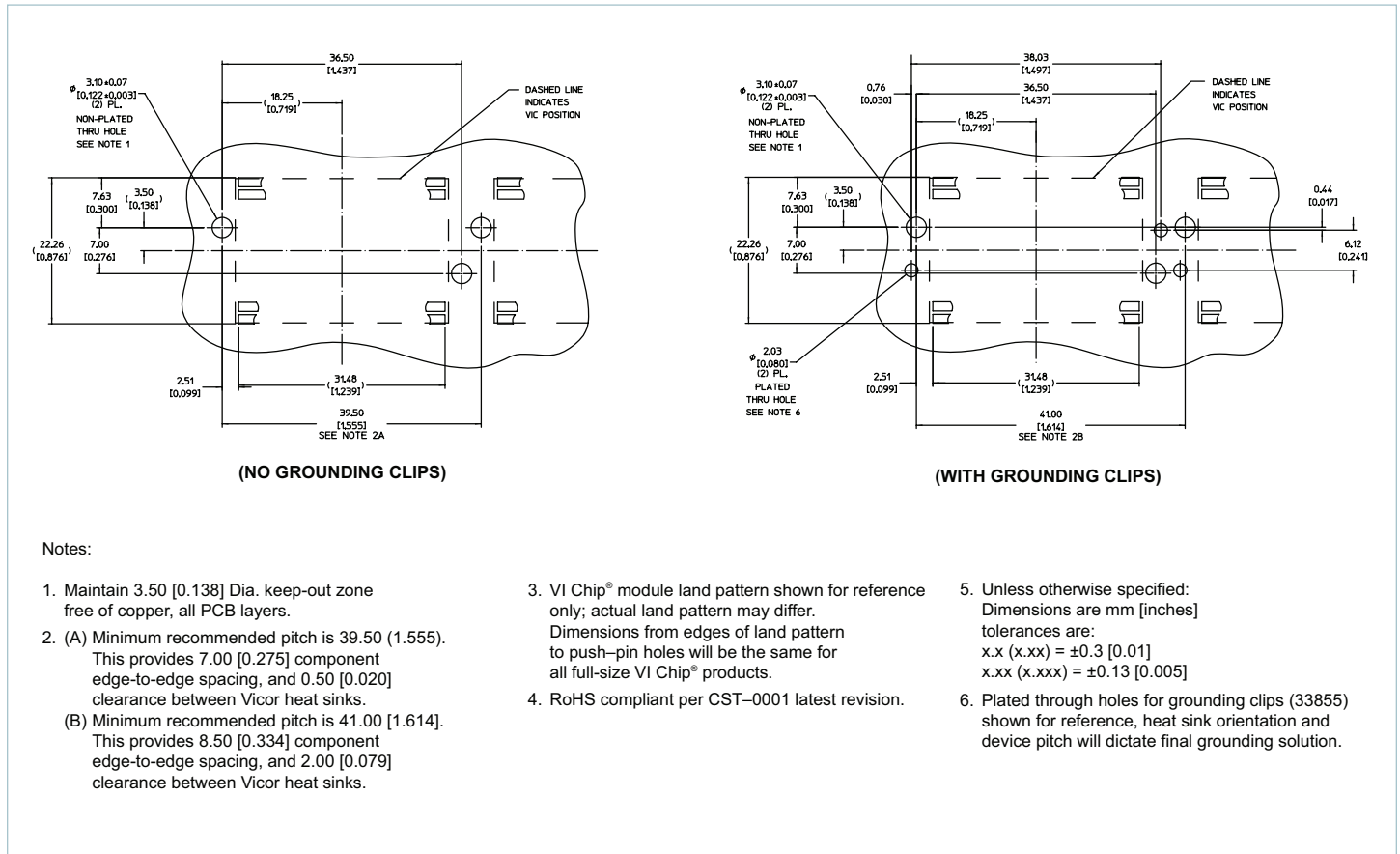

## VTM Module Pin Configuration

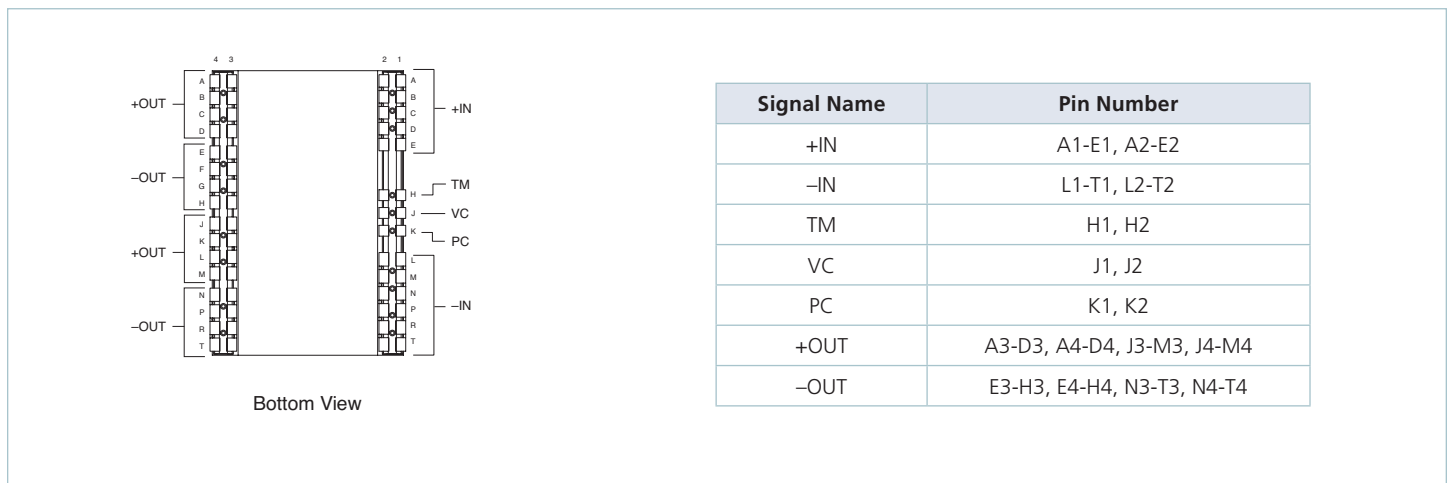

## Revision History

Revision	Date	Description	Page Number(s)
1.8	01/05/21	Provided additional information to soldering guidelines	10

**Vicor's comprehensive line of power solutions includes high density AC-DC and DC-DC modules and accessory components, fully configurable AC-DC and DC-DC power supplies, and complete custom power systems.**

Information furnished by Vicor is believed to be accurate and reliable. However, no responsibility is assumed by Vicor for its use. Vicor makes no representations or warranties with respect to the accuracy or completeness of the contents of this publication. Vicor reserves the right to make changes to any products, specifications, and product descriptions at any time without notice. Information published by Vicor has been checked and is believed to be accurate at the time it was printed; however, Vicor assumes no responsibility for inaccuracies. Testing and other quality controls are used to the extent Vicor deems necessary to support Vicor's product warranty. Except where mandated by government requirements, testing of all parameters of each product is not necessarily performed.

**Specifications are subject to change without notice.**

Visit <http://www.vicorpower.com/dc-dc-converters-board-mount/vtm> for the latest product information.

### **Vicor's Standard Terms and Conditions and Product Warranty**

All sales are subject to Vicor's Standard Terms and Conditions of Sale, and Product Warranty which are available on Vicor's webpage (<http://www.vicorpower.com/termsconditionswarranty>) or upon request.

### **Life Support Policy**

VICOR'S PRODUCTS ARE NOT AUTHORIZED FOR USE AS CRITICAL COMPONENTS IN LIFE SUPPORT DEVICES OR SYSTEMS WITHOUT THE EXPRESS PRIOR WRITTEN APPROVAL OF THE CHIEF EXECUTIVE OFFICER AND GENERAL COUNSEL OF VICOR CORPORATION. As used herein, life support devices or systems are devices which (a) are intended for surgical implant into the body, or (b) support or sustain life and whose failure to perform when properly used in accordance with instructions for use provided in the labeling can be reasonably expected to result in a significant injury to the user. A critical component is any component in a life support device or system whose failure to perform can be reasonably expected to cause the failure of the life support device or system or to affect its safety or effectiveness. Per Vicor Terms and Conditions of Sale, the user of Vicor products and components in life support applications assumes all risks of such use and indemnifies Vicor against all liability and damages.

### **Intellectual Property Notice**

Vicor and its subsidiaries own Intellectual Property (including issued U.S. and Foreign Patents and pending patent applications) relating to the products described in this data sheet. No license, whether express, implied, or arising by estoppel or otherwise, to any intellectual property rights is granted by this document. Interested parties should contact Vicor's Intellectual Property Department.

The products described on this data sheet are protected by the following U.S. Patents Numbers:

5,945,130; 6,403,009; 6,710,257; 6,911,848; 6,930,893; 6,934,166; 6,940,013; 6,969,909; 7,038,917; 7,145,786; 7,166,898; 7,187,263; 7,202,646; 7,361,844; D496,906; D505,114; D506,438; D509,472; and for use under 6,975,098 and 6,984,965.

Contact Us: <http://www.vicorpower.com/contact-us>

#### **Vicor Corporation**

25 Frontage Road  
Andover, MA, USA 01810  
Tel: 800-735-6200  
Fax: 978-475-6715  
[www.vicorpower.com](http://www.vicorpower.com)

#### **email**

Customer Service: [custserv@vicorpower.com](mailto:custserv@vicorpower.com)  
Technical Support: [apps@vicorpower.com](mailto:apps@vicorpower.com)

## X-ON Electronics

Largest Supplier of Electrical and Electronic Components

*Click to view similar products for [Isolated DC/DC Converters](#) category:*

*Click to view products by [Vicor](#) manufacturer:*

Other Similar products are found below :

[ESM6D044440C05AAQ](#) [FMD15.24G](#) [PSL486-7LR](#) [Q48T30020-NBB0](#) [JAHW100Y1](#) [SPB05C-12](#) [SQ24S15033-PS0S](#) [18952](#) [19-130041](#)  
[CE-1003](#) [CE-1004](#) [GQ2541-7R](#) [RDS180245](#) [MAU228](#) [J80-0041NL](#) [DFC15U48D15](#) [XGS-0512](#) [XGS-1205](#) [XGS-1212](#) [XGS-2412](#) [XGS-](#)  
[2415](#) [XKS-1215](#) [06322](#) [NCT1000N040R050B](#) [SPB05B-15](#) [SPB05C-15](#) [L-DA20](#) [DCG40-5G](#) [QME48T40033-PGB0](#) [XKS-2415](#) [XKS-2412](#)  
[XKS-1212](#) [XKS-1205](#) [XKS-0515](#) [XKS-0505](#) [XGS-2405](#) [XGS-1215](#) [XGS-0515](#) [PS9Z-6RM4](#) [73-551-5038I](#) [AK1601-9RT](#) [VI-N61-CM](#) [VI-](#)  
[R5022-EXWW](#) [PSC128-7iR](#) [RPS8-350ATX-XE](#) [DAS1004812](#) [PQA30-D24-S24-DH](#) [VI-M5F-CQ](#) [VI-LN2-EW](#) [VI-PJW01-CZY](#)