



High Efficiency, Bi-directional, Sine Amplitude Converter™

Features & Benefits

- 48V_{DC} to 4V_{DC} 50A bi-directional current multiplier
- Can power a load connected to either the primary or secondary side
- High efficiency (>94%) reduces system power consumption
- High density (170A/in³)
- “Full Chip” VI Chip® package enables surface mount, low impedance interconnect to system board
- Contains built-in protection features against:
 - Overvoltage Lockout
 - Overcurrent
 - Short Circuit
 - Overtemperature
- Provides enable/disable control, internal temperature monitoring
- ZVS/ZCS resonant Sine Amplitude Converter topology
- Less than 50°C temperature rise at full load in typical applications

Typical Applications

- High End Computing Systems
- Automated Test Equipment
- High Density Power Supplies
- Communications Systems

Typical Application

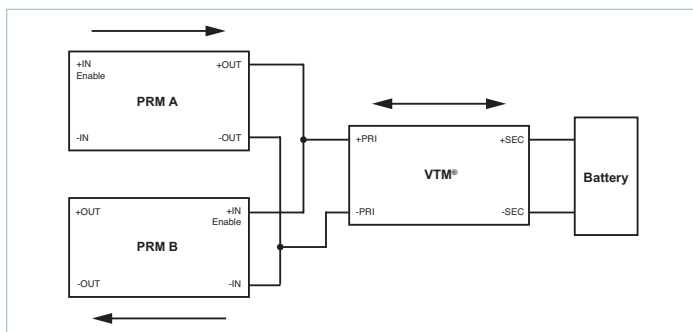

Description

The VI Chip® bi-directional current multiplier is a Sine Amplitude Converter™ (SAC™) operating from a 26 to 55V_{DC} primary source or a 2.2 to 4.6V_{DC} secondary source to power a load. The bi-directional Sine Amplitude Converter isolates and transforms voltage at a secondary:primary ratio of 1/12. The SAC offers a low AC impedance beyond the bandwidth of most downstream regulators; therefore for a step-down conversion; capacitance normally at the load can be located at the source to the Sine Amplitude Converter to enable a reduction in size of capacitors. Since the K factor of the VTM48EF040T050B0R is 1/12, the capacitance value on the primary side can be reduced by a factor of 144 in an application where the source is located on the primary side, resulting in savings of board area, materials and total system cost.

The VTM48EF040T050B0R is provided in a VI Chip package compatible with standard pick-and-place and surface mount assembly processes. The co-molded VI Chip package provides enhanced thermal management due to a large thermal interface area and superior thermal conductivity. The high conversion efficiency of the VTM48EF040T050B0R increases overall system efficiency and lowers operating costs compared to conventional approaches.

The VTM48EF040T050B0R enables the utilization of Factorized Power Architecture™ which provides efficiency and size benefits by lowering conversion and distribution losses and promoting high density point of load conversion.

Product Ratings	
V _{PRI} = 26 – 55V	I _{SEC} = 50A (NOM)
V _{SEC} = 2.2 – 4.6V (NO LOAD)	K = 1/12

Part Numbering

Product Number	Package Style	Product Grade
VTM48Ex040y050B0R	F = J-Lead	T = -40° to 125°C
	T = Through hole	M = -55° to 125°C

For Storage and Operating Temperatures see General Characteristics Section

Absolute Maximum Ratings

The absolute maximum ratings below are stress ratings only. Operation at or beyond these maximum ratings can cause permanent damage to the device.

Parameter	Comments	Min	Max	Unit
+PRI to -PRI		-1.0	60	V _{DC}
PC to -PRI		-0.3	20	V _{DC}
TM to -PRI		-0.3	7	V _{DC}
VC to -PRI		-0.3	20	V _{DC}
+PRI / -PRI to +SEC / -SEC (hipot)			2250	V _{DC}
+SEC to -SEC		-0.5	40	V _{DC}

Primary Source Electrical Specifications

Specifications apply over all line and load conditions when power is sourced from the primary side, unless otherwise noted; **Boldface** specifications apply over the temperature range of $-40^{\circ}\text{C} < T_J < 125^{\circ}\text{C}$ (T-Grade); All other specifications are at $T_J = 25^{\circ}\text{C}$ unless otherwise noted.

Attribute	Symbol	Conditions / Notes	Min	Typ	Max	Unit
Primary voltage range	V _{PRI}	No external VC applied	26		55	V _{DC}
		VC applied	0		55	
V _{PRI} slew rate	dV _{PRI} /dt				1	V/μs
V _{PRI} UV turn off	V _{PRI_UV}	Module latched shutdown, No external VC applied, I _{OUT} = 50A		24	26	V
No Load power dissipation	P _{NL}	V _{PRI} = 48V	1.5		10	W
		V _{PRI} = 26V to 55V			12	
		V _{PRI} = 48V, T _C = 25°C		4.7	6.3	
		V _{PRI} = 26V to 55V, T _C = 25°C			8	
Inrush current peak	I _{INRP}	VC enable, V _{PRI} = 48V, C _{SEC} = 9100μF, R _{LOAD} = 78mΩ		10	20	A
DC input current	I _{PRI_DC}				4.5	A
Transfer ratio	K	$K = V_{SEC} / V_{PRI}$, I _{SEC} = 0A		1/12		V / V
Secondary voltage	V _{SEC}	$V_{SEC} = V_{PRI} \cdot K - I_{SEC} \cdot R_{SEC}$, See Page 13				V
Secondary current (average)	I _{SEC_AVG}				54	A
Secondary current (peak)	I _{SEC_PK}	t _{PEAK} < 10ms, I _{OUT_AVG} ≤ 50A			75	A
Secondary power (average)	P _{OUT_AVG}	I _{SEC_AVG} ≤ 50A			248	W
Efficiency (ambient)	η _{AMB}	V _{PRI} = 48V, I _{SEC} = 50A	93.1	94.0		%
		V _{PRI} = 26V to 55V, I _{SEC} = 50A	90.2			
		V _{PRI} = 48V, I _{SEC} = 25A	92.4	93.5		

Primary Source Electrical Specifications (Cont.)

Specifications apply over all line and load conditions when power is sourced from the primary side, unless otherwise noted; **Boldface** specifications apply over the temperature range of $-40^{\circ}\text{C} < T_J < 125^{\circ}\text{C}$ (T-Grade); All other specifications are at $T_J = 25^{\circ}\text{C}$ unless otherwise noted.

Attribute	Symbol	Conditions / Notes	Min	Typ	Max	Unit
Efficiency (hot)	η_{HOT}	$V_{\text{IN}} = 48\text{V}$, $T_C = 100^{\circ}\text{C}$, $I_{\text{SEC}} = 50\text{A}$	93.0	94.0		%
Efficiency (over load range)	$\eta_{20\%}$	$10\text{A} < I_{\text{SEC}} < 50\text{A}$	80.0			%
Secondary resistance (cold)	$R_{\text{SEC_COLD}}$	$T_C = -40^{\circ}\text{C}$, $I_{\text{SEC}} = 50\text{A}$	1.5	2.0	2.6	m Ω
Secondary resistance (ambient)	$R_{\text{SEC_AMB}}$	$T_C = 25^{\circ}\text{C}$, $I_{\text{SEC}} = 50\text{A}$	1.8	2.5	3.0	m Ω
Secondary resistance (hot)	$R_{\text{SEC_HOT}}$	$T_C = 100^{\circ}\text{C}$, $I_{\text{SEC}} = 50\text{A}$	2.0	2.7	3.3	m Ω
Switching frequency	F_{SW}		1.36	1.43	1.50	MHz
Secondary ripple frequency	$F_{\text{SW_RP}}$		2.72	2.86	3.00	MHz
Secondary voltage ripple	$V_{\text{SEC_PP}}$	$C_{\text{OUT}} = 0\text{F}$, $I_{\text{SEC}} = 50\text{A}$, $V_{\text{PRI}} = 48\text{V}$, 20MHz BW		216	350	mV
Secondary inductance (parasitic)	$L_{\text{SEC_PAR}}$	Frequency up to 30MHz, Simulated J-lead model		600		pH
Secondary capacitance (internal)	$C_{\text{SEC_INT}}$	Effective Value at $4V_{\text{SEC}}$		200		μF
Secondary capacitance (external)	$C_{\text{SEC_EXT}}$	VTM Standalone Operation. V_{PRI} pre-applied, VC enable			9100	μF
Protection						
Primary Overvoltage lockout	$V_{\text{PRI_OVLO+}}$	Module latched shutdown	55.1	58.5	60.0	V
Primary Overvoltage lockout response time constant	t_{OVLO}	Effective internal RC filter		8		μs
Secondary overcurrent trip	$I_{\text{OCP_SEC}}$		53	78	100	A
Secondary Short circuit protection trip current	$I_{\text{SCP_SEC}}$		100			A
Secondary overcurrent response time constant	$t_{\text{OCP_SEC}}$	Effective internal RC filter (Integrative)		6.2		ms
Secondary Short circuit protection response time	$t_{\text{SCP_SEC}}$	From detection to cessation of switching (Instantaneous)		1		μs
Thermal shutdown setpoint	$T_{\text{J_OTP}}$		125	130	135	$^{\circ}\text{C}$
Reverse inrush current protection		Reverse Inrush protection is enabled for this product				

Secondary Source Electrical Specifications

Specifications apply over all line and load conditions when power is sourced from the secondary side, unless otherwise noted; **Boldface** specifications apply over the temperature range of $-40^{\circ}\text{C} < T_J < 125^{\circ}\text{C}$ (T-Grade); All other specifications are at $T_J = 25^{\circ}\text{C}$ unless otherwise noted.

Attribute	Symbol	Conditions / Notes	Min	Typ	Max	Unit
Secondary voltage range	V_{SEC}	No external VC applied	2.17		4.58	V_{DC}
		VC applied	0		5	
V_{SEC} slew rate	dV_{SEC}/dt				1	$V/\mu\text{s}$
V_{SEC} UV turn off	$V_{\text{SEC_UV}}$	Module latched shutdown, No external VC applied, $I_{\text{PRI}} = 4.2\text{A}$		2.0	2.2	V
No Load power dissipation	$P_{\text{NL_SEC}}$	$V_{\text{SEC}} = 4\text{V}$	1.5		10.0	W
		$V_{\text{SEC}} = 2.17\text{V}$ to 4.58V			12.0	
		$V_{\text{SEC}} = 4\text{V}$, $T_C = 25^{\circ}\text{C}$		4.7	6.3	
		$V_{\text{SEC}} = 2.17\text{V}$ to 4.58V , $T_C = 25^{\circ}\text{C}$			8.0	
Inrush current peak	$I_{\text{IN_SEC_P}}$	VC enable, $V_{\text{SEC}} = 4\text{V}$, $C_{\text{PRI}} = 63\mu\text{F}$, $R_{\text{LOAD}} = 11\Omega$		120	240	A
DC secondary current	$I_{\text{SEC_DC}}$				54.0	A
Primary voltage	V_{PRI}	$V_{\text{PRI}} = V_{\text{SEC}} / K - I_{\text{PRI}} \cdot R_{\text{PRI}}$, See Page 13				V
Primary current (average)	$I_{\text{PRI_AVG}}$				4.2	A
Primary current (peak)	$I_{\text{PRI_PK}}$	$t_{\text{PEAK}} < 10\text{ms}$, $I_{\text{PRI_AVG}} \leq 4.2\text{A}$			6.3	A
Primary power (average)	$P_{\text{PRI_AVG}}$	$I_{\text{PRI_AVG}} \leq 4.2\text{A}$			230	W
Efficiency (ambient)	η_{AMB}	$V_{\text{SEC}} = 4\text{V}$, $I_{\text{PRI}} = 4.2\text{A}$	93.1	94.0		%
		$V_{\text{SEC}} = 2.17\text{V}$ to 4.58V , $I_{\text{PRI}} = 4.2\text{A}$	90.2			
		$V_{\text{SEC}} = 4\text{V}$, $I_{\text{PRI}} = 2.1\text{A}$	92.4	93.5		
Efficiency (hot)	η_{HOT}	$V_{\text{SEC}} = 4\text{V}$, $T_C = 100^{\circ}\text{C}$, $I_{\text{PRI}} = 4.2\text{A}$	93.0	94.0		%
Efficiency (over load range)	$\eta_{20\%}$	$0.8\text{A} < I_{\text{PRI}} < 4.2\text{A}$	80.0			%
Primary resistance (cold)	$R_{\text{PRI_COLD}}$	$T_C = -40^{\circ}\text{C}$, $I_{\text{PRI}} = 4.2\text{A}$	380	420	460	$\text{m}\Omega$
Primary resistance (ambient)	$R_{\text{PRI_AMB}}$	$T_C = 25^{\circ}\text{C}$, $I_{\text{PRI}} = 4.2\text{A}$	430	473	545	$\text{m}\Omega$
Primary resistance (hot)	$R_{\text{PRI_HOT}}$	$T_C = 100^{\circ}\text{C}$, $I_{\text{PRI}} = 4.2\text{A}$	480	521	560	$\text{m}\Omega$
Primary voltage ripple	$V_{\text{PRI_PP}}$	$C_{\text{PRI}} = 0\text{F}$, $I_{\text{PRI}} = 4.2\text{A}$, $V_{\text{SEC}} = 4\text{V}$, 2.2MHz BW			600	mV
Primary capacitance (external)	$C_{\text{PRI_EXT}}$	VTM Standalone Operation. V_{SEC} pre-applied, VC enable			63	μF
Protection						
Secondary OVLO	$V_{\text{SEC_OVLO+}}$	Module latched shutdown	4.6	4.9	5.0	V
Secondary Overvoltage lockout response time constant	$t_{\text{OVLO_SEC}}$	Effective internal RC filter		8		μs
Primary overcurrent trip	$I_{\text{OCP_PRI}}$		4	6	8	A
Primary Short circuit protection trip current	$I_{\text{SCP_PRI}}$		8			A
Primary overcurrent response time constant	$t_{\text{OCP_PRI}}$	Effective internal RC filter (Integrative)		6.2		ms
Primary Short circuit protection response time	$t_{\text{SCP_PRI}}$	From detection to cessation of switching (Instantaneous)		1		μs

Signal Characteristics

Specifications apply over all line and load conditions when power is sourced from the primary side, unless otherwise noted; **Boldface** specifications apply over the temperature range of $-40^{\circ}\text{C} < T_J < 125^{\circ}\text{C}$ (T-Grade); All other specifications are at $T_J = 25^{\circ}\text{C}$ unless otherwise noted.

VTM CONTROL : VC									
<ul style="list-style-type: none"> • Referenced to -PRI. • Used to wake up powertrain circuit. • A minimum of 11.5V must be applied indefinitely for $V_{PRI} < 26\text{V}$ to ensure normal operation. • VC slew rate must be within range for a succesful start. • PRM™ VC can be used as valid wake-up signal source. • Internal Resistance used in "Adaptive Loop" compensation. • VC voltage may be continuously applied. 									
SIGNAL TYPE	STATE	ATTRIBUTE	SYMBOL	CONDITIONS / NOTES	MIN	TYP	MAX	UNIT	
ANALOG INPUT	Steady	External VC voltage	V_{VC_EXT}	Required for start up, and operation below 26V.	11.5		16.5	V	
		VC current draw	I_{VC}	VC = 11.5V, $V_{PRI} = 0\text{V}$		66	150	mA	
				VC = 11.5V, $V_{PRI} > 26\text{V}$		15			
				VC = 16.5V, $V_{PRI} > 26\text{V}$		83			
				Fault mode. VC > 11.5V		75			
		VC internal diode rating	D_{VC_INT}			100			V
	VC internal resistor	R_{VC_INT}			1			k Ω	
	VC internal resistor temperature coefficient	T_{VC_COEFF}					900	ppm/ $^{\circ}\text{C}$	
	Start Up	VC start up pulse	V_{VC_SP}	$t_{PEAK} < 18\text{ms}$				20	V
		VC slew rate	dVC/dt	Required for proper start up	0.02		0.25		V/ μs
		VC inrush current	I_{INR_VC}	VC = 16.5V, dVC/dt = 0.25V/ μs			1		A
	Transitional	VC to V_{SEC} turn-on delay	t_{ON}	V_{PRI} pre-applied, PC floating, VC enable, $C_{PC} = 0\mu\text{F}$				500	μs
VC to PC delay		t_{VC_PC}	VC = 11.5V to PC high, $V_{PRI} = 0\text{V}$, dVC/dt = 0.25V/ μs		75	125		μs	
Internal VC capacitance		C_{VC_INT}	VC = 0V		3.2			μF	

Signal Characteristics (Cont.)

Specifications apply over all line and load conditions when power is sourced from the primary side, unless otherwise noted; **Boldface** specifications apply over the temperature range of $-40^{\circ}\text{C} < T_J < 125^{\circ}\text{C}$ (T-Grade); All other specifications are at $T_J = 25^{\circ}\text{C}$ unless otherwise noted.

PRIMARY CONTROL : PC								
<ul style="list-style-type: none"> Referenced to -PRI. The PC pin enables and disables the VTM. When held below 2V, the VTM will be disabled. PC pin outputs 5V during normal operation. PC pin is equal to 2.5V during fault mode given $V_{PRI} > 26\text{V}$ or $V_C > 11.5\text{V}$. After successful start up and under no fault condition, PC can be used as a 5 V regulated voltage source with a 2mA maximum current. Module will shutdown when pulled low with an impedance less than 400Ω. In an array of VTMs, connect PC pin to synchronize start up. PC pin cannot sink current and will not disable other modules during fault mode. 								
SIGNAL TYPE	STATE	ATTRIBUTE	SYMBOL	CONDITIONS / NOTES	MIN	TYP	MAX	UNIT
ANALOG OUTPUT	Steady	PC voltage	V_{PC}		4.7	5.0	5.3	V
		PC source current	I_{PC_OP}				2	mA
		PC resistance (internal)	R_{PC_OP}	Internal pull down resistor	50	150	400	k Ω
	Start Up	PC source current	I_{PC_EN}		50	100	300	μA
		PC capacitance (internal)	C_{PC_INT}				1000	pF
		PC resistance (external)	R_{PC_S}		60			k Ω
DIGITAL INPUT/ OUTPUT	Enable	PC voltage	V_{PC_EN}		2	2.5	3	V
	Disable	PC voltage (disable)	V_{PC_DIS}				2	V
		PC pull down current	I_{PC_PD}		5.1			mA
	Transitional	PC disable time	$t_{PC_DIS_T}$			5		μs
		PC fault response time	t_{FR_PC}	From fault to PC = 2V		100		μs

Temperature Monitor : TM								
<ul style="list-style-type: none"> Referenced to -PRI. The TM pin monitors the internal temperature of the VTM controller IC within an accuracy of $\pm 5^{\circ}\text{C}$. Can be used as a "Power Good" flag to verify that the VTM is operating. The TM pin has a room temperature setpoint of 3V and approximate gain of 10mV/$^{\circ}\text{C}$. Output drives Temperature Shutdown comparator. 								
SIGNAL TYPE	STATE	ATTRIBUTE	SYMBOL	CONDITIONS / NOTES	MIN	TYP	MAX	UNIT
ANALOG OUTPUT	Steady	TM voltage	V_{TM_AMB}	T_J controller = 27 $^{\circ}\text{C}$	2.95	3.00	3.05	V
		TM source current	I_{TM}				100	μA
		TM gain	A_{TM}			10		mV/ $^{\circ}\text{C}$
		TM voltage ripple	V_{TM_PP}	$C_{TM} = 0\text{F}$, $V_{PRI} = 48\text{V}$, $I_{SEC} = 50\text{A}$		120	200	mV
DIGITAL OUTPUT (FAULT FLAG)	Disable	TM voltage	V_{TM_DIS}			0		V
	Transitional	TM resistance (internal)	R_{TM_INT}	Internal pull down resistor	25	40	50	k Ω
		TM capacitance (external)	C_{TM_EXT}				50	pF
		TM fault response time	t_{FR_TM}	From fault to TM = 1.5V		10		μs

Timing Diagram (Power sourced from the primary side)

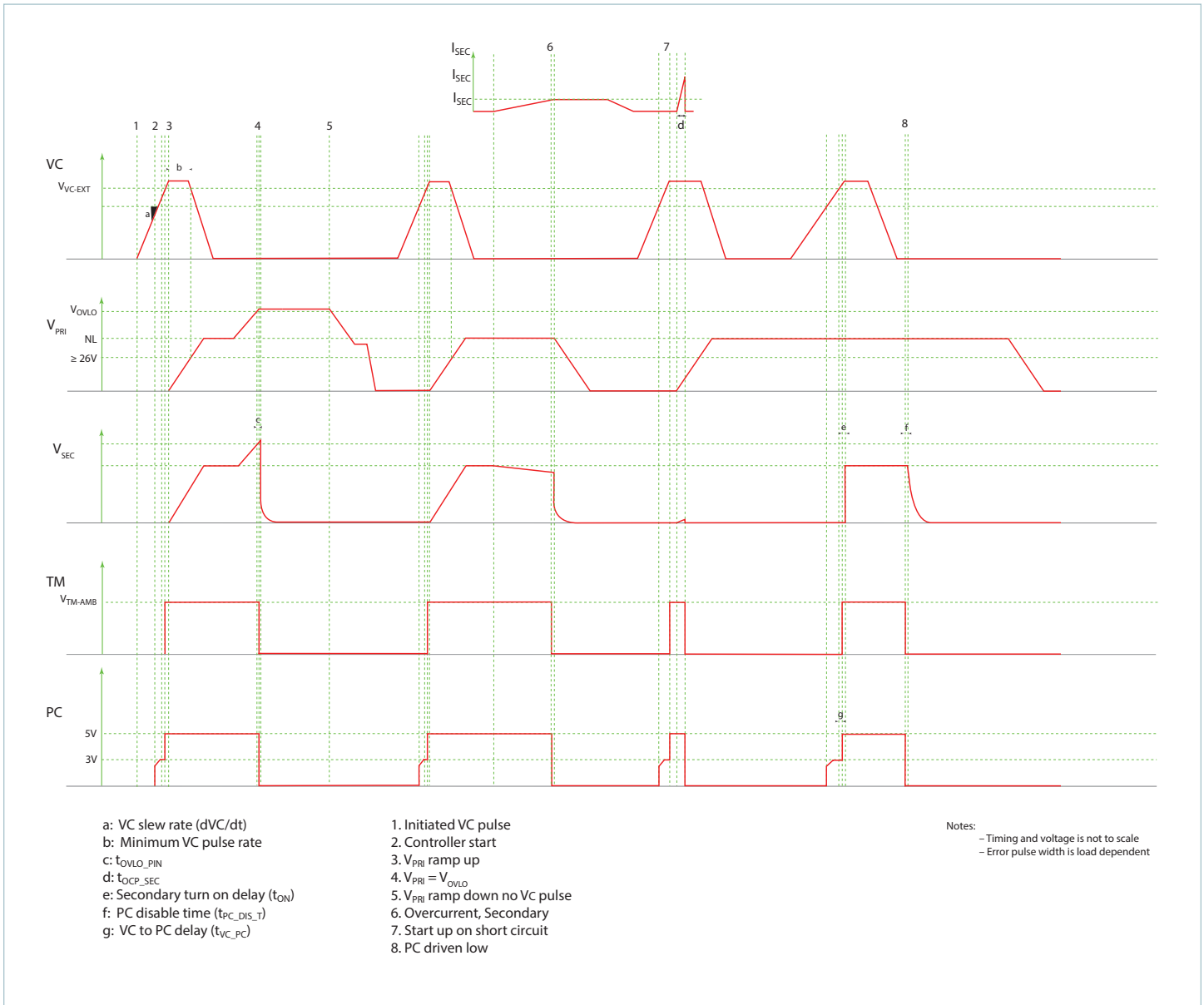

Application Characteristics

The following values, typical of an application environment, are collected at $T_C = 25^\circ\text{C}$ with power sourced from the primary side unless otherwise noted. See associated figures for general trend data.

ATTRIBUTE	SYMBOL	CONDITIONS / NOTES	TYP	UNIT
No load power dissipation	P_{NL}	$V_{PRI} = 48\text{V}$, PC enabled	4.7	W
Efficiency (ambient)	η_{AMB}	$V_{PRI} = 48\text{V}$, $I_{SEC} = 50\text{A}$	94.3	%
Efficiency (hot)	η_{HOT}	$V_{PRI} = 48\text{V}$, $I_{SEC} = 50\text{A}$, $T_C = 100^\circ\text{C}$	94.2	%
Secondary resistance (cold)	R_{SEC_COLD}	$V_{PRI} = 48\text{V}$, $I_{SEC} = 50\text{A}$, $T_C = -40^\circ\text{C}$	2.4	$\text{m}\Omega$
Secondary resistance (ambient)	R_{SEC_AMB}	$V_{PRI} = 48\text{V}$, $I_{SEC} = 50\text{A}$	2.8	$\text{m}\Omega$
Secondary resistance (hot)	R_{SEC_HOT}	$V_{PRI} = 48\text{V}$, $I_{SEC} = 50\text{A}$, $T_C = 100^\circ\text{C}$	3.2	$\text{m}\Omega$
Secondary voltage ripple	V_{SEC_PP}	$C_{SEC} = 0\text{F}$, $I_{SEC} = 50\text{A}$, $V_{PRI} = 48\text{V}$, 20MHz BW	320	mV
V_{OUT} transient (positive)	V_{SEC_TRAN+}	$I_{SEC_STEP} = 0\text{A}$ to 50A , $V_{PRI} = 48\text{V}$, $I_{SLEW} = 17\text{A}/\mu\text{s}$	750	mV
V_{OUT} transient (negative)	V_{SEC_TRAN-}	$I_{SEC_STEP} = 50\text{A}$ to 0A , $V_{PRI} = 48\text{V}$, $I_{SLEW} = 0\text{A}/\mu\text{s}$	750	mV

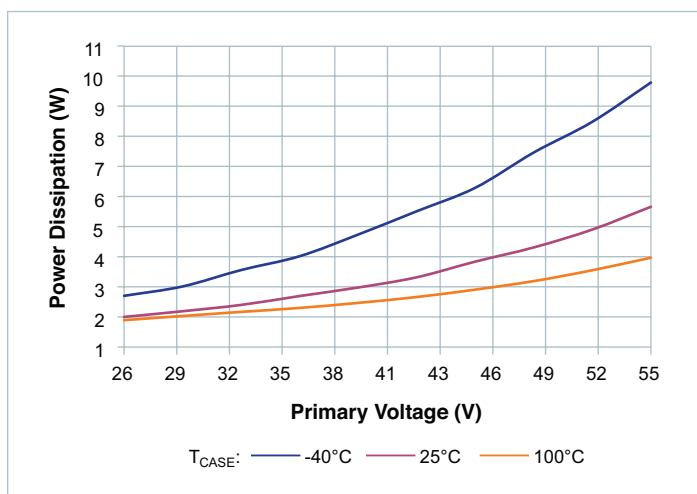

Figure 1 — No load power dissipation vs. V_{PRI}

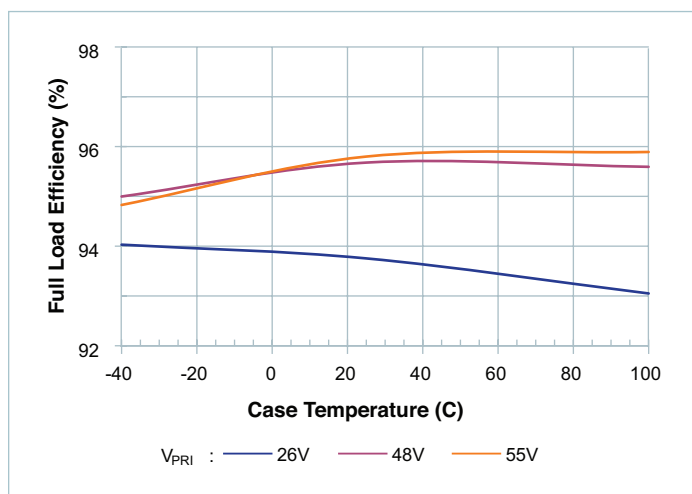

Figure 2 — Full secondary load efficiency vs. temperature

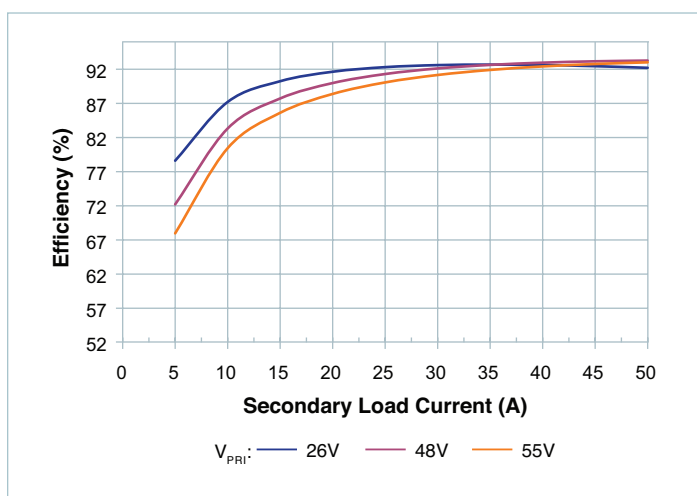

Figure 3 — Efficiency at -40°C

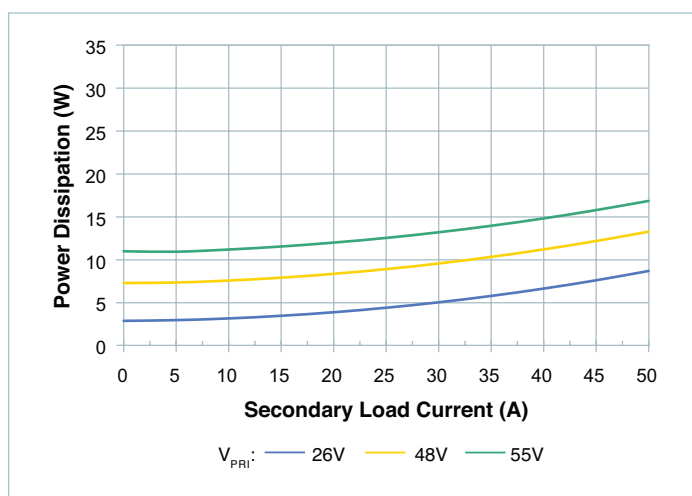

Figure 4 — Power dissipation at -40°C

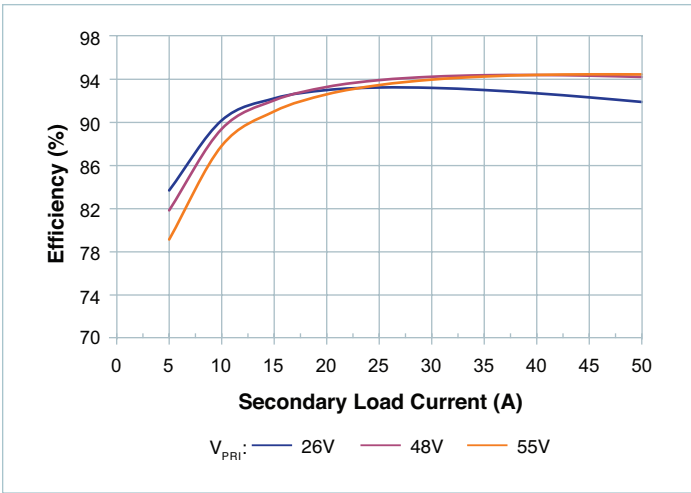

Figure 5 — Efficiency at 25°C

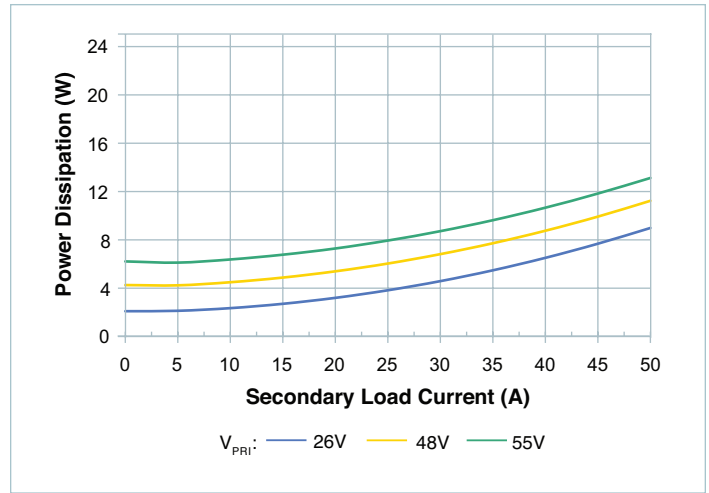

Figure 6 — Power dissipation at 25°C

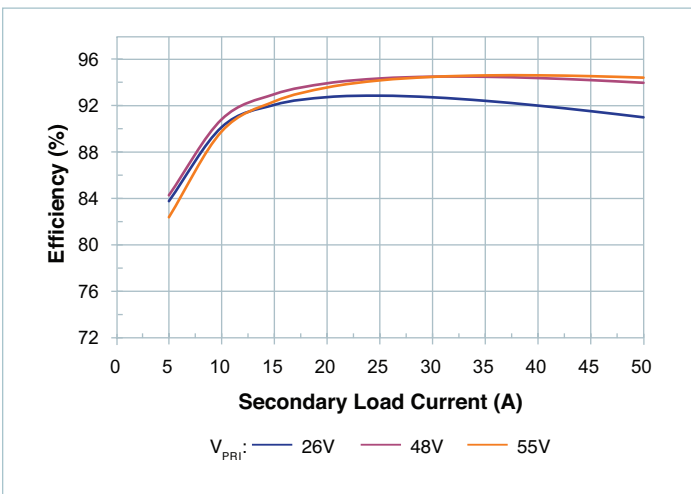

Figure 7 — Efficiency at 100°C

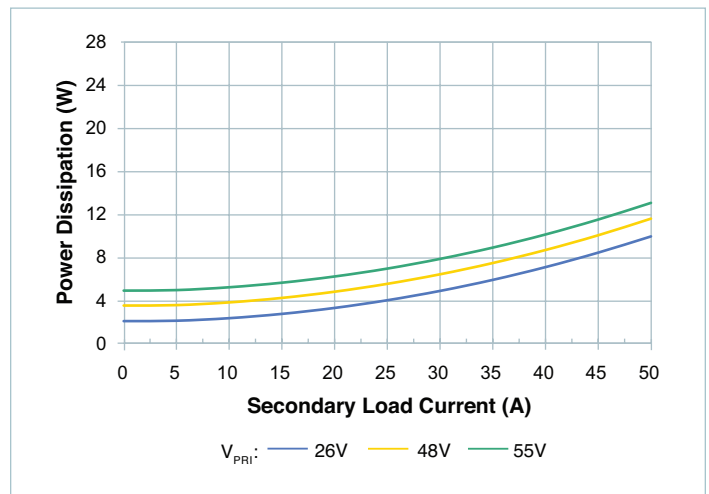

Figure 8 — Power dissipation at 100°C

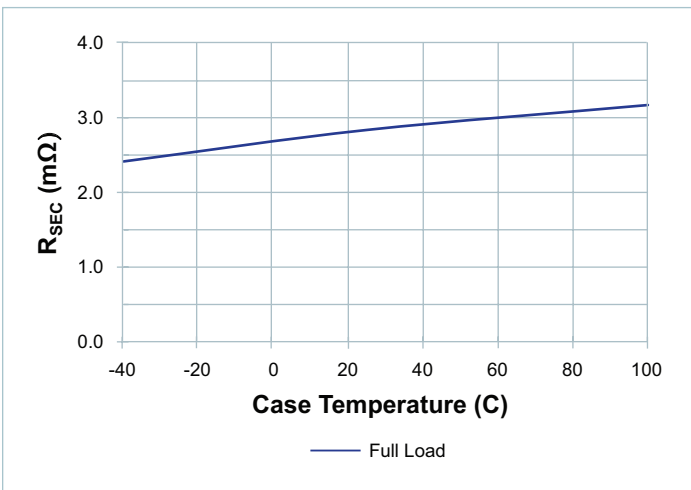

Figure 9 — R_{SEC} vs. temperature

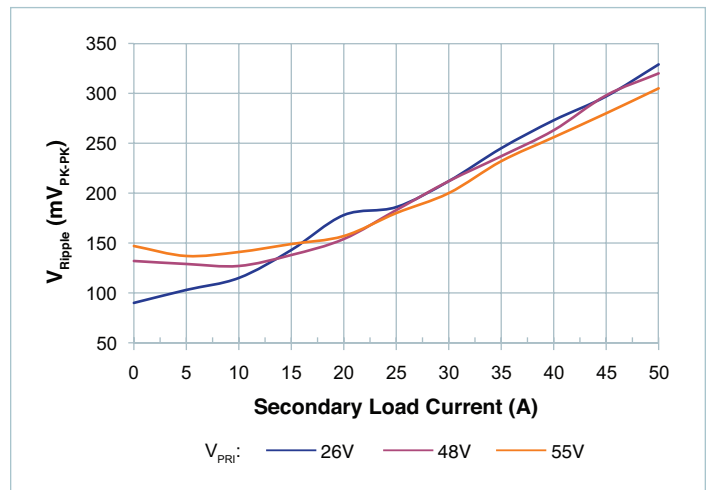

Figure 10 — V_{ripple} vs. I_{SEC}; No external C_{SEC}. Board mounted module, scope setting: 20MHz analog BW

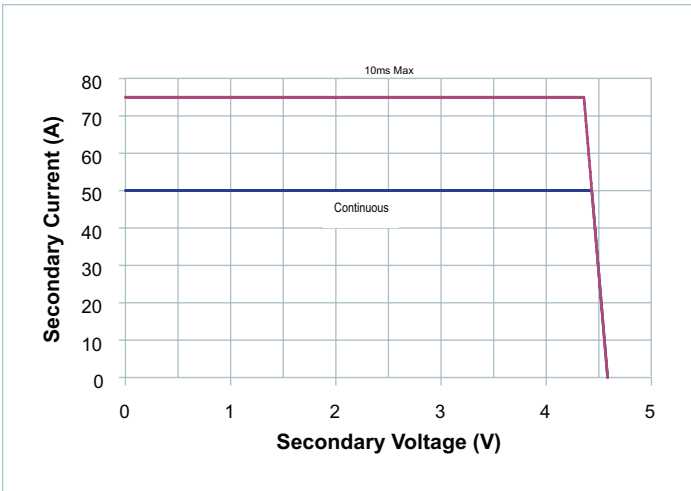

Figure 11 — Safe operating area

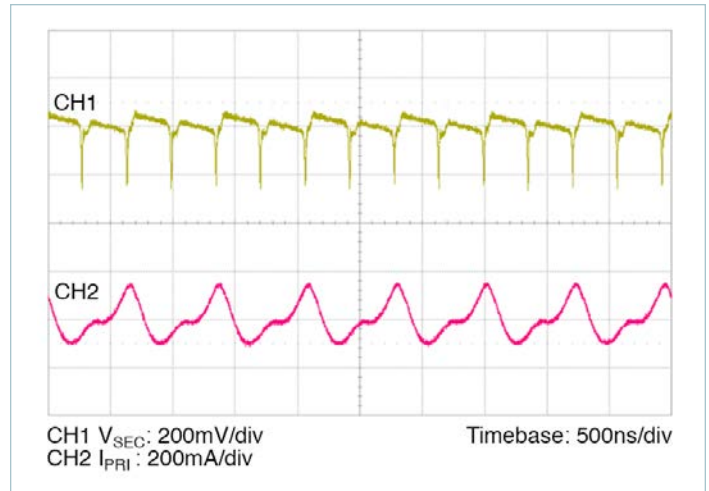

Figure 12 — Full load ripple, 100 μ F C_{PRI} ; No external C_{SEC} . Board mounted module, scope setting: 20MHz analog BW

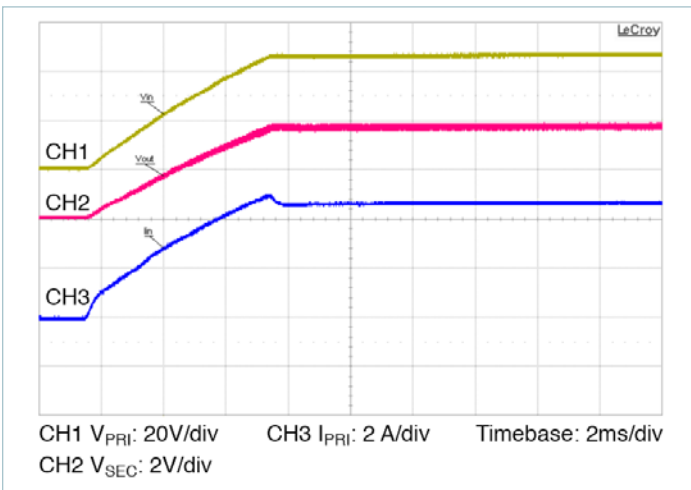

Figure 13 — Start up from application of V_{PRI} ; V_C pre-applied $C_{SEC} = 9100\mu F$

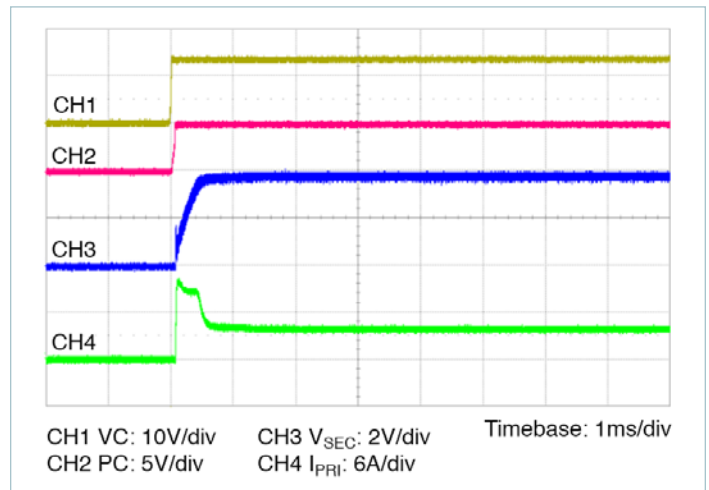

Figure 14 — Start up from application of V_C ; V_{PRI} pre-applied $C_{SEC} = 9100\mu F$

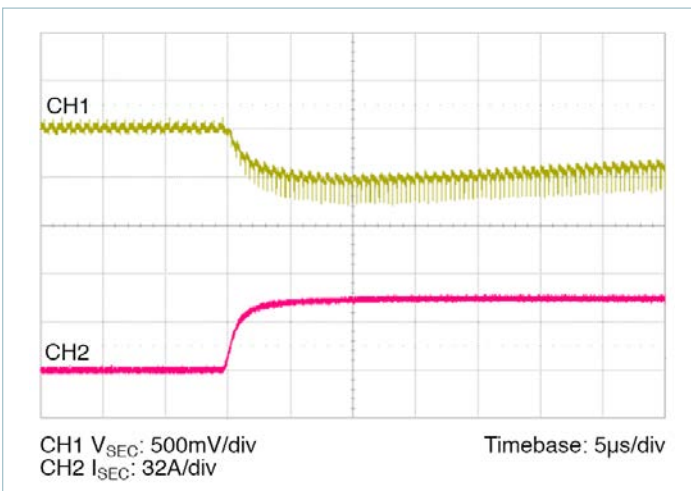

Figure 15 — 0A – Full load transient response: $C_{PRI} = 100\mu F$, no external C_{SEC}

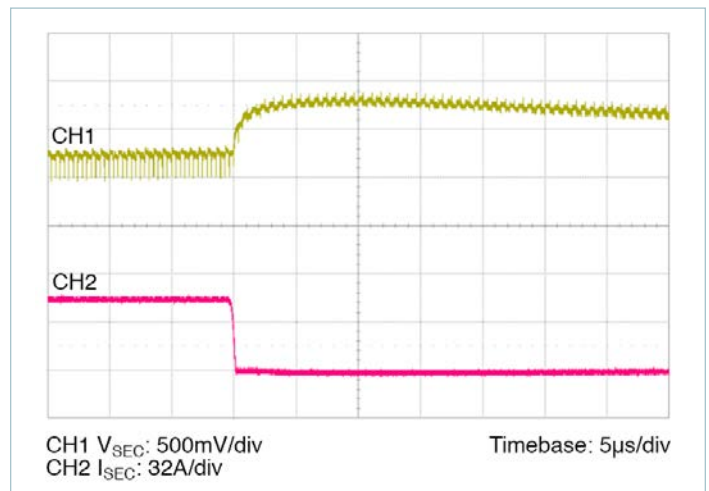

Figure 16 — Full load – 0A transient response: $C_{PRI} = 100\mu F$, no external C_{SEC}

General Characteristics

Specifications apply over all line and load conditions with power sourced from primary side unless otherwise noted; **Boldface** specifications apply over the temperature range of $-40^{\circ}\text{C} < T_j < 125^{\circ}\text{C}$ (T-Grade); All Other specifications are at $T_j = 25^{\circ}\text{C}$ unless otherwise noted.

Attribute	Symbol	Conditions / Notes	Min	Typ	Max	Unit
Mechanical						
Length	L		32.25 / [1.270]	32.5 / [1.280]	32.75 / [1.289]	mm/[in]
Width	W		21.75 / [0.856]	22.0 / [0.866]	22.25 / [0.876]	mm/[in]
Height	H		6.48 / [0.255]	6.73 / [0.265]	6.98 / [0.275]	mm/[in]
Volume	Vol	No heat sink		4.81 / [0.294]		cm ³ /[in ³]
Weight	W			15.0 / [0.53]		g/[oz]
Lead Finish		Nickel	0.51		2.03	μm
		Palladium	0.02		0.15	
		Gold	0.003		0.051	
Thermal						
Operating temperature	T _J	VTM48EF040T050B0R (T-Grade)	-40		125	°C
		VTM48EF040M050B0R (M-Grade)	-55		125	
		VTM48ET040T050B0R (T-Grade)	-40		125	
		VTM48ET040M050B0R (M-Grade)	-55		125	
Thermal resistance	θ _{JC}	Isothermal heat sink and isothermal internal PCB		1		°C/W
Thermal capacity				5		Ws/°C
Assembly						
Peak compressive force applied to case (Z-axis)		Supported by J-lead only			6	lbs
					5.41	lbs/in ²
Storage temperature	T _{ST}	VTM48EF040T050B0R (T-Grade)	-40		125	°C
		VTM48EF040M050B0R (M-Grade)	-65		125	
		VTM48ET040T050B0R (T-Grade)	-40		125	
		VTM48ET040M050B0R (M-Grade)	-65		125	
ESD withstand	ESD _{HBM}	Human Body Model, "JEDEC JESD 22-A114-F"	1000			V _{DC}
	ESD _{CDM}	Charge Device Model, "JEDEC JESD 22-C101-D"	400			
Soldering						
Peak temperature during reflow		MSL 4 (Datecode 1528 and later)			245	°C
Peak time above 217°C				60	90	s
Peak heating rate during reflow				1.5	3	°C/s
Peak cooling rate post reflow				1.5	6	°C/s

General Characteristics (Cont.)

Specifications apply over all line and load conditions with power sourced from primary side unless otherwise noted; **Boldface** specifications apply over the temperature range of $-40^{\circ}\text{C} < T_j < 125^{\circ}\text{C}$ (T-Grade); All Other specifications are at $T_j = 25^{\circ}\text{C}$ unless otherwise noted.

Attribute	Symbol	Conditions / Notes	Min	Typ	Max	Unit
Safety						
Isolation voltage (hipot)	V_{HIPOT}		2250			V_{DC}
Isolation capacitance	$C_{\text{PRI_SEC}}$	Unpowered unit	2500	3200	3800	pF
Isolation resistance	$R_{\text{PRI_SEC}}$		10			M Ω
MTBF		MIL-HDBK-217 Plus Parts Count; 25°C Ground Benign, Stationary, Indoors / Computer Profile		3.8		MHrs
		Telcordia Issue 2 - Method I Case 1; Ground Benign, Controlled		5.7		MHrs
Agency approvals / standards		cTUVus				
		cURus				
		CE Marked for Low Voltage Directive and ROHS Recast Directive, as applicable				

Using the Control Signals VC, PC, TM, IM

The **VTM Control (VC)** pin is a primary referenced pin which powers the internal VCC circuitry when within the specified voltage range of 11.5V to 16.5V. This voltage is required for VTM current multiplier start up and must be applied as long as the primary is below 26V. In order to ensure a proper start, the slew rate of the applied voltage must be within the specified range.

Some additional notes on the using the VC pin:

- In most applications, the VTM module primary side will be powered by an upstream PRM™ regulator which provides a 10ms VC pulse during start up. In these applications the VC pins of the PRM regulator and VTM current multiplier should be tied together.
- In bi-directional applications, the primary of the VTM may also be providing power to a PRM input. In these applications, a proper VC voltage within the specified range must be applied any time the primary voltage of the VTM is below 26V.
- The VC voltage can be applied indefinitely allowing for continuous operation down to 0V_{PR1}.
- The fault response of the VTM module is latching. A positive edge on VC is required in order to restart the unit. If VC is continuously applied the PC pin may be toggled to restart the VTM module.

Primary Control (PC) is a primary referenced pin that can be used to accomplish the following functions:

- Delayed start: Upon the application of VC, the PC pin will source a constant 100µA current to the internal RC network. Adding an external capacitor will allow further delay in reaching the 2.5V threshold for module start.
- Auxiliary voltage source: Once enabled in regular operational conditions (no fault), each VTM PC provides a regulated 5V, 2mA voltage source.
- Disable: PC pin can be actively pulled down in order to disable the module. Pull down impedance shall be lower than 400Ω.
- Fault detection flag: The PC 5V voltage source is internally turned off as soon as a fault is detected. It is important to notice that PC doesn't have current sink capability. Therefore, in an array, PC line will not be capable of disabling neighboring modules if a fault is detected.
- Fault reset: PC may be toggled to restart the unit if VC is continuously applied.

Temperature Monitor (TM) is a primary referenced pin that provides a voltage proportional to the absolute temperature of the converter control IC.

It can be used to accomplish the following functions:

- Monitor the control IC temperature: The temperature in Kelvin is equal to the voltage on the TM pin scaled by 100. (i.e. 3.0V = 300K = 27°C). If a heat sink is applied, TM can be used to thermally protect the system.

- Fault detection flag: The TM voltage source is internally turned off as soon as a fault is detected. For system monitoring purposes (microcontroller interface) faults are detected on falling edges of TM signal.

Start Up Behavior

Depending on the sequencing of the VC voltage with respect to the same voltage, whether the source is on the primary or secondary, the behavior during start up will vary as follows:

- Normal operation (VC applied prior to the source voltage): In this case, the controller is active prior to the source ramping. When the source voltage is applied, the VTM module load voltage will track the source (See Figure 13). The inrush current is determined by the source voltage rate of rise and load capacitance. If the VC voltage is removed prior to the primary voltage reaching 26V, the VTM may shut down.
- Stand-alone operation (VC applied after V_{PR1}): In this case the VTM secondary will begin to rise upon the application of the VC voltage (See Figure 14). The Adaptive Soft Start Circuit may vary the secondary voltage rate of rise in order to limit the inrush current to its maximum level. When starting into high capacitance, or a short, the secondary current will be limited for a maximum of 1200µs. After this period, the Adaptive Soft Start Circuit will time out and the VTM module may shut down. No restart will be attempted until VC is re-applied or PC is toggled. The maximum secondary capacitance is limited to 9100µF in this mode of operation to ensure a successful start.

Thermal Considerations

VI Chip® products are multi-chip modules whose temperature distribution varies greatly for each part number as well as with the line/load conditions, thermal management and environmental conditions. Maintaining the top of the VTM48EF040T050B0R case to less than 100°C will keep all junctions within the VI Chip module below 125°C for most applications.

The percent of total heat dissipated through the top surface versus through the J-lead is entirely dependent on the particular mechanical and thermal environment. The heat dissipated through the top surface is typically 60%. The heat dissipated through the J-lead onto the PCB board surface is typically 40%. Use 100% top surface dissipation when designing for a conservative cooling solution.

It is not recommended to use a VI Chip module for an extended period of time at full load without proper heat sinking.

Sine Amplitude Converter™ Point of Load Conversion

The Sine Amplitude Converter (SAC) uses a high frequency resonant tank to move energy from primary to secondary or vice-versa, depending on where the source is located. The resonant tank is formed by Cr and leakage inductance Lr in the power transformer windings. The resonant LC tank, operated at high frequency, is amplitude modulated as a function of primary voltage and secondary current. A small amount of capacitance embedded

in the primary and secondary stages of the module is sufficient for full functionality and is key to achieving power density.

The VTM48EF040T050B0R SAC can be simplified into the following model:

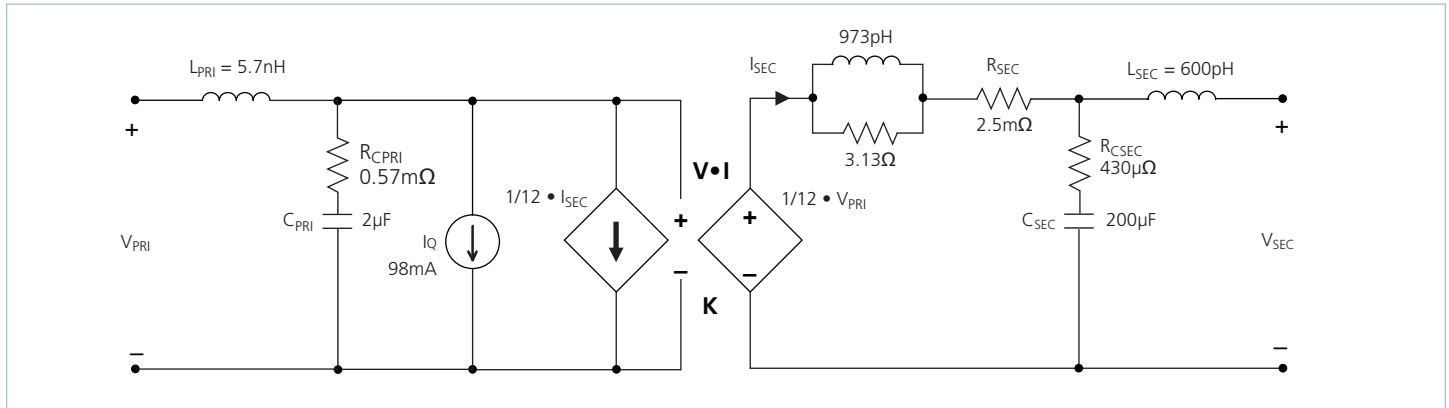

Figure 17 — VI Chip® module AC model

At no load:

$$V_{SEC} = V_{PRI} \cdot K \tag{1}$$

K represents the “turns ratio” of the SAC.

Rearranging Eq (1):

$$K = \frac{V_{SEC}}{V_{PRI}} \tag{2}$$

In the presence of load, V_{SEC} is represented by:

$$V_{SEC} = V_{PRI} \cdot K - I_{SEC} \cdot R_{SEC} \tag{3}$$

and I_{SEC} is represented by:

$$I_{SEC} = \frac{I_{PRI} - I_Q}{K} \tag{4}$$

R_{SEC} represents the impedance of the SAC, and is a function of the R_{DSON} of the primary and secondary MOSFETs and the winding resistance of the power transformer. I_Q represents the quiescent current of the SAC control and gate drive circuitry. For applications where the source is located on the secondary side, equations 1 to 4 can be re-arranged to represent V_{PRI} and I_{PRI} as a function of V_{SEC} and I_{SEC} .

The use of DC voltage transformation provides additional interesting attributes. Assuming that $R_{SEC} = 0\Omega$ and $I_Q = 0A$, Eq. (3) now becomes Eq. (1) and is essentially load independent, resistor R is now placed in series with V_{PRI} as shown in Figure 18.

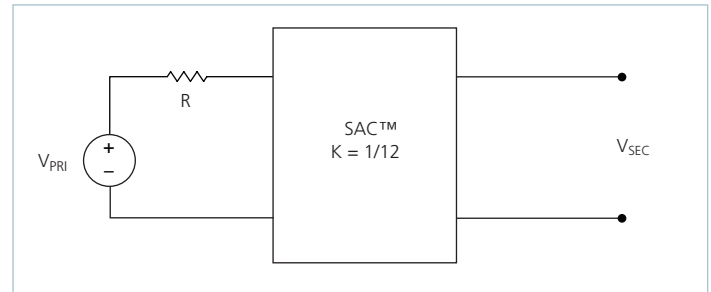

Figure 18 — K = 1/12 Sine Amplitude Converter™ with series primary resistor

The relationship between V_{PRI} and V_{SEC} becomes:

$$V_{SEC} = (V_{PRI} - I_{PRI} \cdot R_{SEC}) \cdot K \tag{5}$$

Substituting the simplified version of Eq. (4) (I_Q is assumed = 0A) into Eq. (5) yields:

$$V_{SEC} = V_{PRI} \cdot K - I_{SEC} \cdot R_{SEC} \cdot K^2 \tag{6}$$

This is similar in form to Eq. (3), where R_{SEC} is used to represent the characteristic impedance of the SAC™. However, in this case a real R on the primary side of the SAC is effectively scaled by K^2 with respect to the secondary.

Assuming that $R = 1\Omega$, the effective R as seen from the secondary side is $6.9m\Omega$, with $K = 1/12$ as shown in Figure 18.

A similar exercise should be performed with the addition of a capacitor or shunt impedance at the primary to the SAC. A switch in series with V_{IN} is added to the circuit. This is depicted in Figure 19.

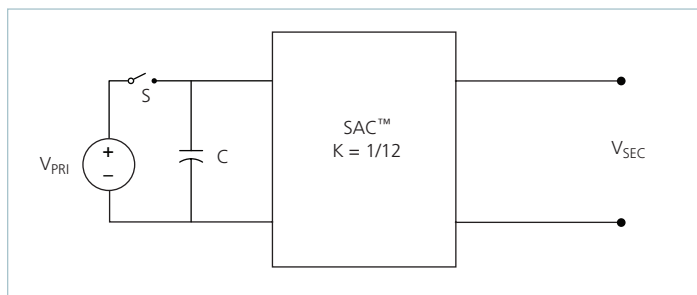

Figure 19 — Sine Amplitude Converter™ with primary capacitor

A change in V_{PRI} with the switch closed would result in a change in capacitor current according to the following equation:

$$I_C(t) = C \frac{dV_{PRI}}{dt} \quad (7)$$

Assume that with the capacitor charged to V_{PRI} , the switch is opened and the capacitor is discharged through the idealized SAC. In this case,

$$I_C = I_{SEC} \cdot K \quad (8)$$

Substituting Eq. (1) and (8) into Eq. (7) reveals:

$$I_{SEC} = \frac{C}{K^2} \cdot \frac{dV_{SEC}}{dt} \quad (9)$$

The equation in terms of the secondary has yielded a K^2 scaling factor for C, specified in the denominator of the equation. A K factor less than unity, results in an effectively larger capacitance on the secondary when expressed in terms of the primary. With a $K = 1/12$ as shown in Figure 19, $C = 1\mu F$ would appear as $C = 144\mu F$ when viewed from the secondary. Note that in situations where the source voltage is located on the secondary side, the effect is reversed and effective value of capacitance located on the secondary side is divided by a factor of $1/K^2$ when reflected to the primary.

Low impedance is a key requirement for powering a high-current, low voltage load efficiently. A switching regulation stage should have minimal impedance while simultaneously providing appropriate filtering for any switched current. The use of a SAC between the regulation stage and the point of load provides a dual benefit of scaling down series impedance leading back to the source and scaling up shunt capacitance or energy storage as a function of its K factor squared. However, the benefits are not useful if the series impedance of the SAC is too high. The impedance of the SAC must be low, i.e. well beyond the crossover frequency of the system.

A solution for keeping the impedance of the SAC low involves switching at a high frequency. This enables small magnetic components because magnetizing currents remain low. Small magnetics mean small path lengths for turns. Use of low loss core material at high frequencies also reduces core losses.

The two main terms of power loss in the VTM module are:

- No load power dissipation (P_{NL}): defined as the power used to power up the module with an enabled powertrain at no load.
- Resistive loss (R_{SEC}): refers to the power loss across the VTM modeled as pure resistive impedance.

$$P_{DISSIPATED} = P_{NL} + P_{R_{SEC}} \quad (10)$$

Therefore,

$$P_{SEC} = P_{PRI} - P_{DISSIPATED} = P_{PRI} - P_{NL} - P_{R_{SEC}} \quad (11)$$

The above relations can be combined to estimate the overall module efficiency:

$$\begin{aligned} \eta &= \frac{P_{SEC}}{P_{PRI}} = \frac{P_{PRI} - P_{NL} - P_{R_{SEC}}}{P_{PRI}} \quad (12) \\ &= \frac{V_{PRI} \cdot I_{PRI} - P_{NL} - (I_{SEC})^2 \cdot R_{SEC}}{V_{PRI} \cdot I_{PRI}} \\ &= 1 - \left(\frac{P_{NL} + (I_{SEC})^2 \cdot R_{SEC}}{V_{PRI} \cdot I_{PRI}} \right) \end{aligned}$$

Primary and Secondary Filter Design

A major advantage of a SAC™ system versus a conventional PWM converter is that the former does not require large functional filters. The resonant LC tank, operated at extreme high frequency, is amplitude modulated as a function of primary voltage and secondary current and efficiently transfers charge through the isolation transformer. A small amount of capacitance embedded in the primary and secondary stages of the module is sufficient for full functionality and is key to achieving high power density.

This paradigm shift requires system design to carefully evaluate external filters in order to:

- **Guarantee low source impedance.**

To take full advantage of the VTM module dynamic response, the impedance presented to its input terminals must be low from DC to approximately 5MHz. Input capacitance may be added to improve transient performance or compensate for high source impedance.

- **Further reduce input and/or output voltage ripple without sacrificing dynamic response.**

Given the wide bandwidth of the VTM module, the source response is generally the limiting factor in the overall system response. Anomalies in the response of the source will appear at the output of the VTM module multiplied by its K factor.

- **Protect the module from overvoltage transients imposed by the system that would exceed maximum ratings and cause failures.**

The VI Chip® module input/output voltage ranges must not be exceeded. An internal overvoltage lockout function prevents operation outside of the normal operating input range. Even during this condition, the powertrain is exposed to the applied voltage and power MOSFETs must withstand it.

Capacitive Filtering Considerations for a Sine Amplitude Converter™

It is important to consider the impact of adding input and output capacitance to a Sine Amplitude Converter on the system as a whole. Both the capacitance value and the effective impedance of the capacitor must be considered.

A Sine Amplitude Converter has a DC R_{OUT} value which has already been discussed in Page 13. The AC R_{OUT} of the SAC contains several terms:

- Resonant tank impedance
- Input lead inductance and internal capacitance
- Output lead inductance and internal capacitance

The values of these terms are shown in the behavioral model in Page 13. It is important to note on which side of the transformer these impedances appear and how they reflect across the transformer given the K factor.

The overall AC impedance varies from model to model. For most models it is dominated by DC R_{OUT} value from DC to beyond 500KHz. The behavioral model in Page 13 should be used to approximate the AC impedance of the specific model.

Any capacitors placed at the output of the VTM module reflect back to the input of the module by the square of the K factor (Eq. 9) with the impedance of the module appearing in series. It is very important to keep this in mind when using a PRM™ regulator to power the VTM module. Most PRM modules have a limit on the maximum amount of capacitance that can be applied to the output. This capacitance includes both the PRM output capacitance and the VTM module output capacitance reflected back to the input. In PRM module remote sense applications, it is important to consider the reflected value of VTM module output capacitance when designing and compensating the PRM module control loop.

Capacitance placed at the input of the VTM module appear to the load reflected by the K factor with the impedance of the VTM module in series. In step-down ratios, the effective capacitance is increased by the K factor. The effective ESR of the capacitor is decreased by the square of the K factor, but the impedance of the module appears in series. Still, in most step-down VTM modules an electrolytic capacitor placed at the input of the module will have a lower effective impedance compared to an electrolytic capacitor placed at the output. This is important to consider when placing capacitors at the output of the module. Even though the capacitor may be placed at the output, the majority of the AC current will be sourced from the lower impedance, which in most cases will be the module. This should be studied carefully in any system design using a module. In most cases, it should be clear that electrolytic output capacitors are not necessary to design a stable, well-bypassed system.

Current Sharing

The SAC™ topology bases its performance on efficient transfer of energy through a transformer without the need of closed loop control. For this reason, the transfer characteristic can be approximated by an ideal transformer with some resistive drop and positive temperature coefficient.

This type of characteristic is close to the impedance characteristic of a DC power distribution system, both in behavior (AC dynamic) and absolute value (DC dynamic).

When connected in an array with the same K factor, the VTM module will inherently share the load current (typically 5%) with parallel units according to the equivalent impedance divider that the system implements from the power source to the point of load.

Some general recommendations to achieve matched array impedances:

- Dedicate common copper planes within the PCB to deliver and return the current to the modules.
- Provide the PCB layout as symmetric as possible.
- Apply same input / output filters (if present) to each unit.

For further details see:

[AN:016 Using BCM® Bus Converters in High Power Arrays.](#)

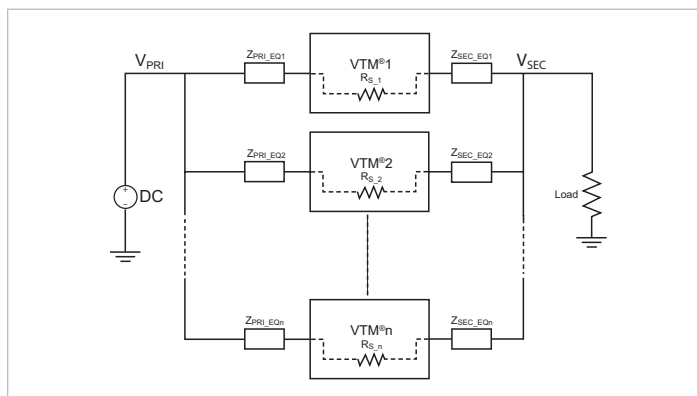

Figure 20 — VTM module array

Fuse Selection

In order to provide flexibility in configuring power systems VI Chip® products are not internally fused. Input line fusing of VI Chip products is recommended at system level to provide thermal protection in case of catastrophic failure.

The fuse shall be selected by closely matching system requirements with the following characteristics:

- Current rating
(usually greater than maximum current of VTM module)
- Maximum voltage rating
(usually greater than the maximum possible input voltage)
- Ambient temperature
- Nominal melting I^2t

Bi-Directional Operation

The VTM48EF040T050B0R is capable of bi-directional operation. If a voltage is present at the secondary which satisfies the condition $V_{SEC} > V_{PRI} \cdot K$ at the time the VC voltage is applied, or after the unit has started, then energy will be transferred from secondary to primary. The primary to secondary ratio will be maintained. The VTM48EF040T050B0R will continue to operate bi-directional as long as the primary and secondary are within the specified limits.

J-Lead Package Mechanical Drawing

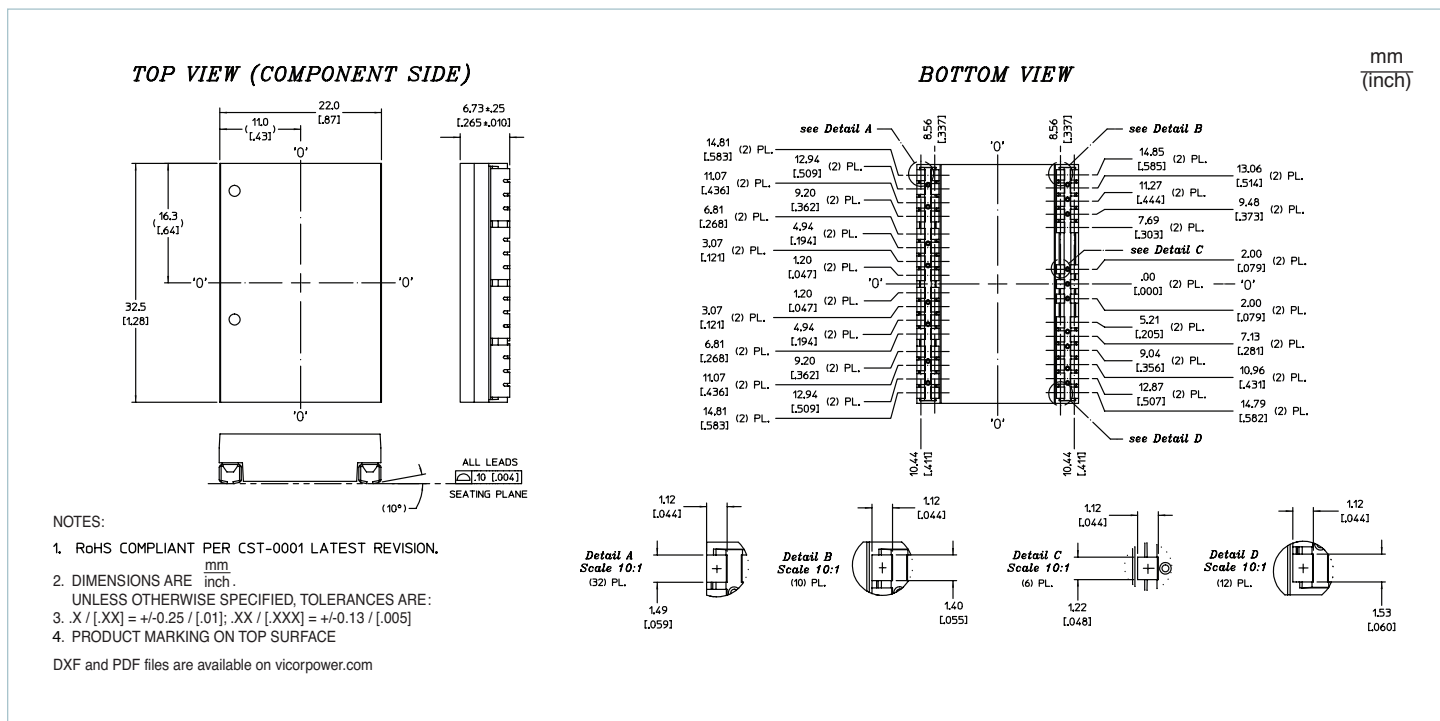

J-Lead Package Recommended Land Pattern

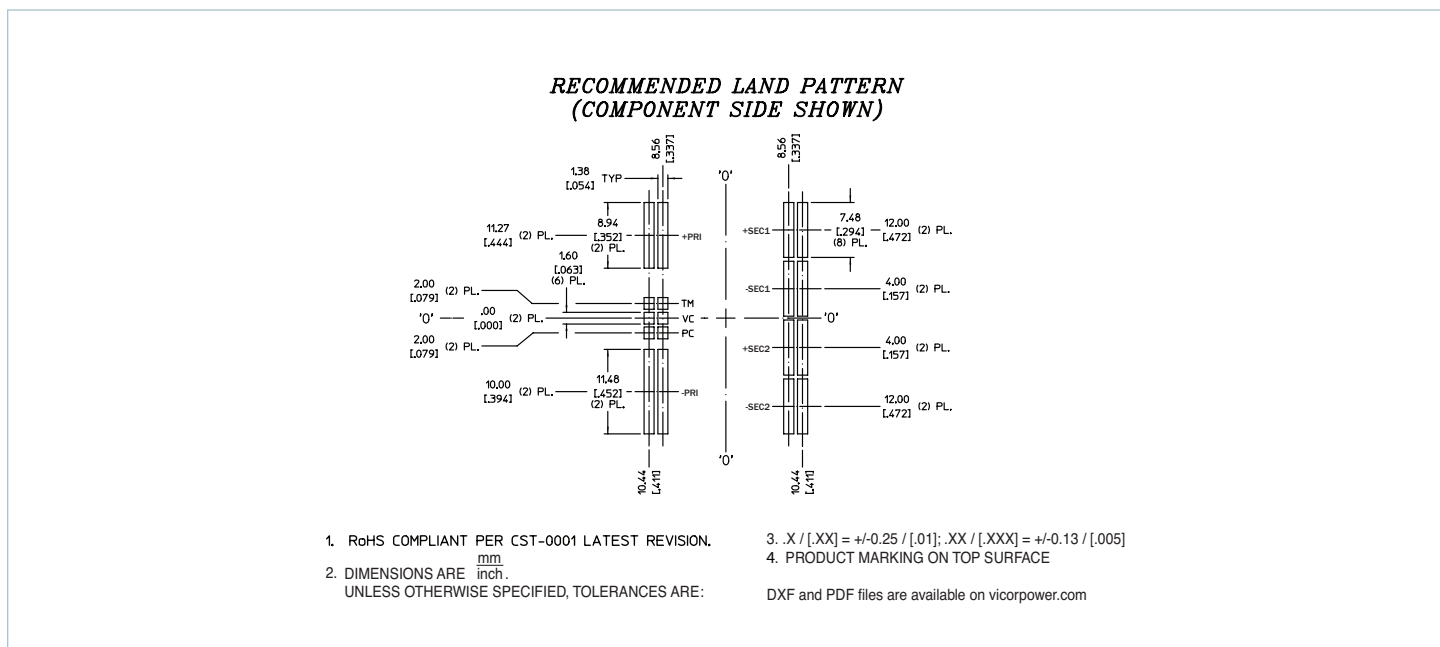

Through-Hole Package Mechanical Drawing

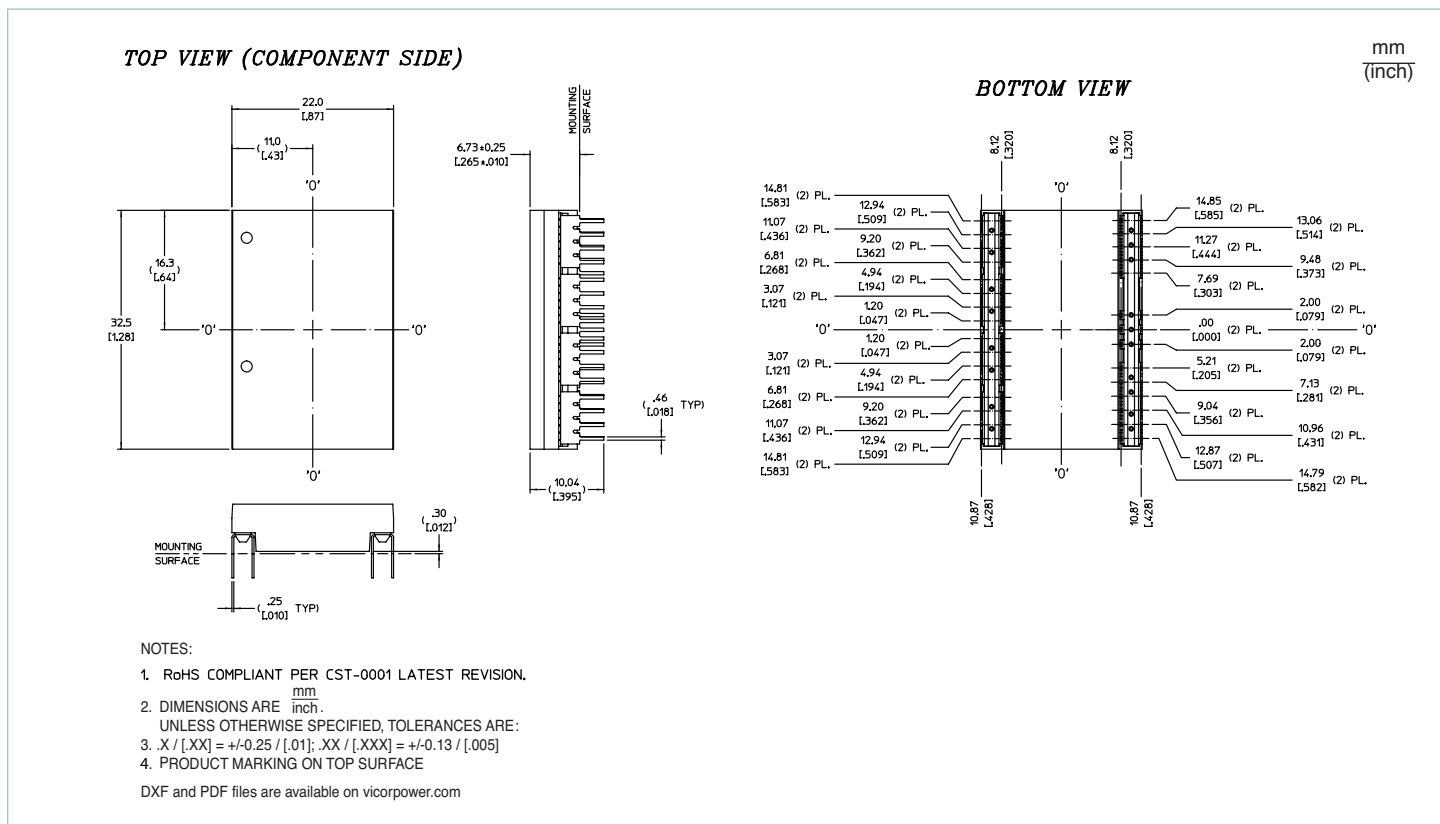

Through-Hole Package Recommended Land Pattern

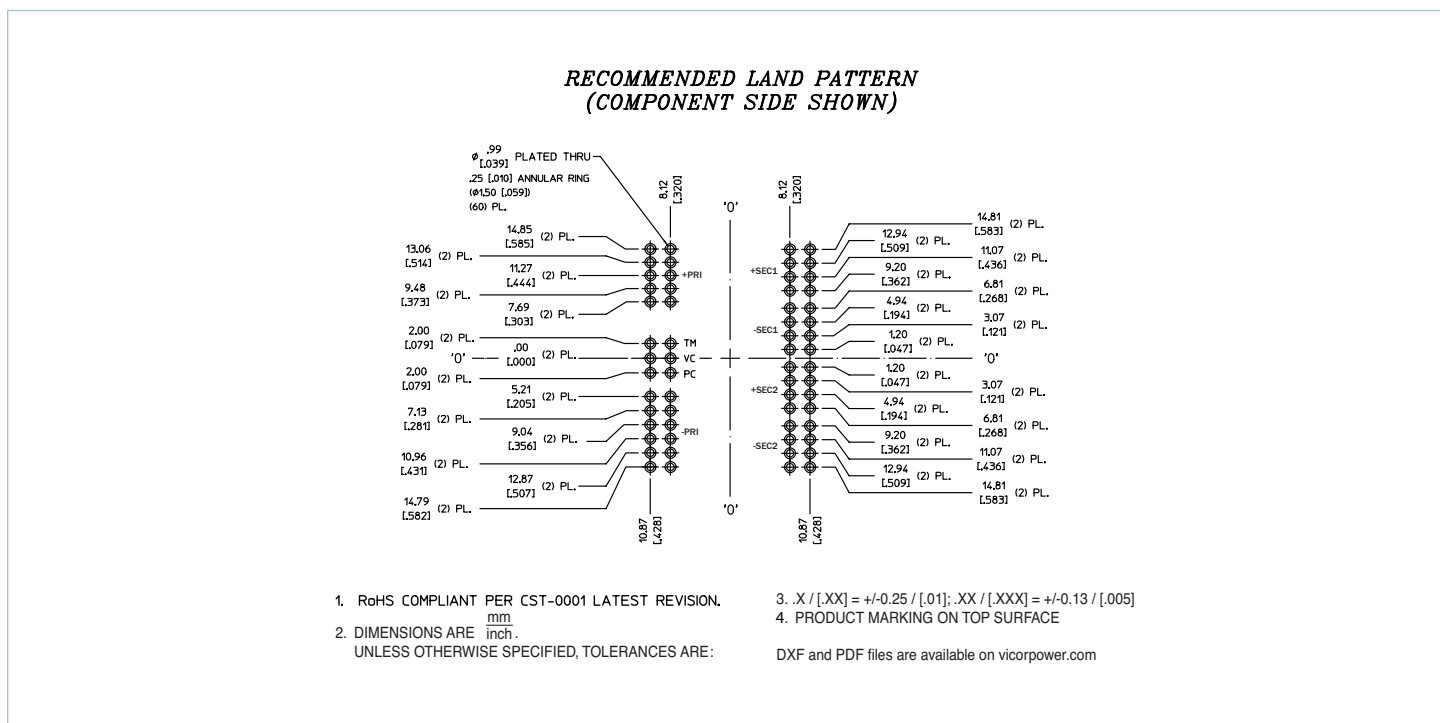

Recommended Heat Sink Push Pin Location

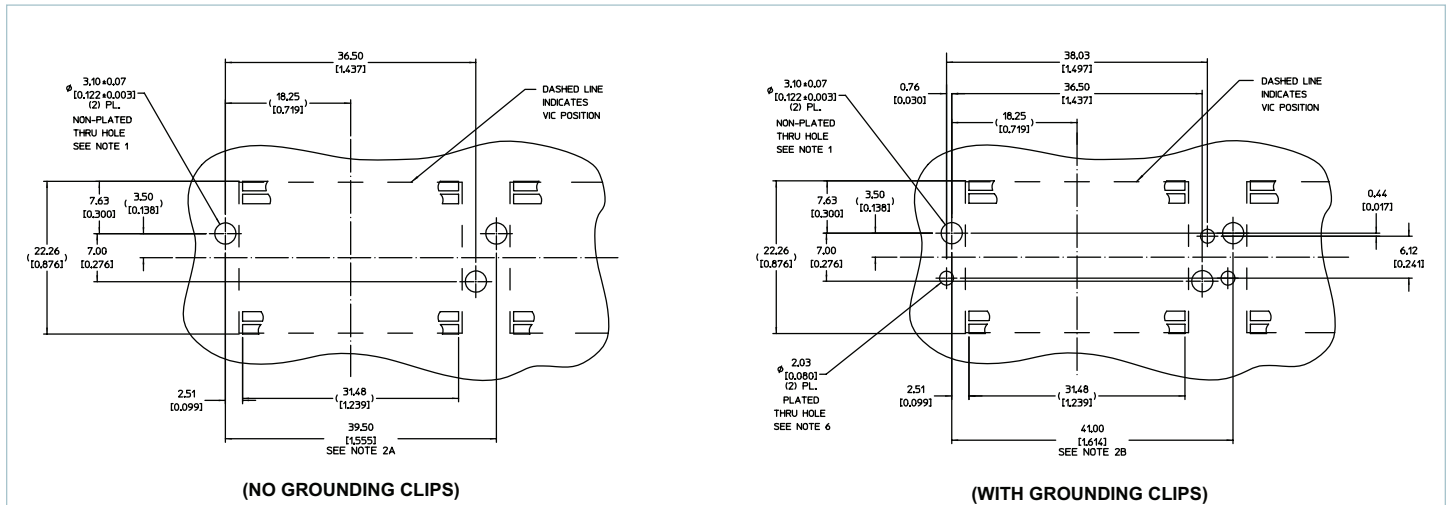

Notes:

- Maintain 3.50 (0.138) Dia. keep-out zone free of copper, all PCB layers.
- (A) Minimum recommended pitch is 39.50 (1.555). This provides 7.00 (0.275) component edge-to-edge spacing, and 0.50 (0.020) clearance between Vicor heat sinks.
(B) Minimum recommended pitch is 41.00 (1.614). This provides 8.50 (0.334) component edge-to-edge spacing, and 2.00 (0.079) clearance between Vicor heat sinks.
- VI Chip® module land pattern shown for reference only; actual land pattern may differ. Dimensions from edges of land pattern to push-pin holes will be the same for all full-size VI Chip® products.
- RoHS compliant per CST-0001 latest revision.
- Unless otherwise specified: Dimensions are mm (inches) tolerances are:
x.x (x.xx) = ±0.3 (0.01)
x.xx (x.xxx) = ±0.13 (0.005)
- Plated through holes for grounding clips (33855) shown for reference, heat sink orientation and device pitch will dictate final grounding solution.

VTM Module Pin Configuration

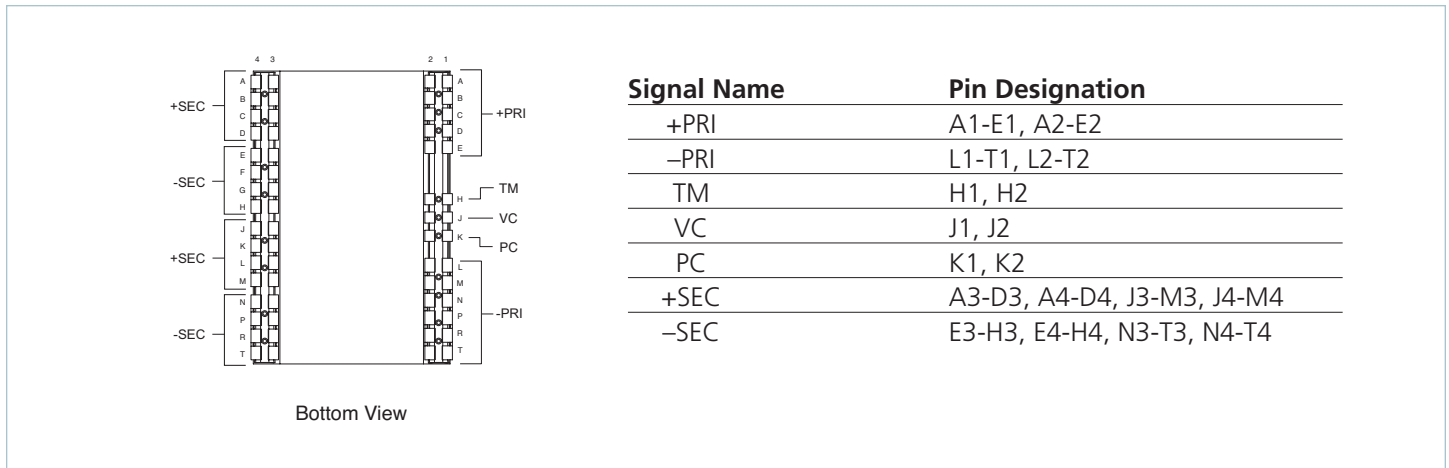

Vicor's comprehensive line of power solutions includes high density AC-DC and DC-DC modules and accessory components, fully configurable AC-DC and DC-DC power supplies, and complete custom power systems.

Information furnished by Vicor is believed to be accurate and reliable. However, no responsibility is assumed by Vicor for its use. Vicor makes no representations or warranties with respect to the accuracy or completeness of the contents of this publication. Vicor reserves the right to make changes to any products, specifications, and product descriptions at any time without notice. Information published by Vicor has been checked and is believed to be accurate at the time it was printed; however, Vicor assumes no responsibility for inaccuracies. Testing and other quality controls are used to the extent Vicor deems necessary to support Vicor's product warranty. Except where mandated by government requirements, testing of all parameters of each product is not necessarily performed.

Specifications are subject to change without notice.

Vicor's Standard Terms and Conditions

All sales are subject to Vicor's Standard Terms and Conditions of Sale, which are available on Vicor's webpage or upon request.

Product Warranty

In Vicor's standard terms and conditions of sale, Vicor warrants that its products are free from non-conformity to its Standard Specifications (the "Express Limited Warranty"). This warranty is extended only to the original Buyer for the period expiring two (2) years after the date of shipment and is not transferable.

UNLESS OTHERWISE EXPRESSLY STATED IN A WRITTEN SALES AGREEMENT SIGNED BY A DULY AUTHORIZED VICOR SIGNATORY, VICOR DISCLAIMS ALL REPRESENTATIONS, LIABILITIES, AND WARRANTIES OF ANY KIND (WHETHER ARISING BY IMPLICATION OR BY OPERATION OF LAW) WITH RESPECT TO THE PRODUCTS, INCLUDING, WITHOUT LIMITATION, ANY WARRANTIES OR REPRESENTATIONS AS TO MERCHANTABILITY, FITNESS FOR PARTICULAR PURPOSE, INFRINGEMENT OF ANY PATENT, COPYRIGHT, OR OTHER INTELLECTUAL PROPERTY RIGHT, OR ANY OTHER MATTER.

This warranty does not extend to products subjected to misuse, accident, or improper application, maintenance, or storage. Vicor shall not be liable for collateral or consequential damage. Vicor disclaims any and all liability arising out of the application or use of any product or circuit and assumes no liability for applications assistance or buyer product design. Buyers are responsible for their products and applications using Vicor products and components. Prior to using or distributing any products that include Vicor components, buyers should provide adequate design, testing and operating safeguards.

Vicor will repair or replace defective products in accordance with its own best judgment. For service under this warranty, the buyer must contact Vicor to obtain a Return Material Authorization (RMA) number and shipping instructions. Products returned without prior authorization will be returned to the buyer. The buyer will pay all charges incurred in returning the product to the factory. Vicor will pay all reshipment charges if the product was defective within the terms of this warranty.

Life Support Policy

VICOR'S PRODUCTS ARE NOT AUTHORIZED FOR USE AS CRITICAL COMPONENTS IN LIFE SUPPORT DEVICES OR SYSTEMS WITHOUT THE EXPRESS PRIOR WRITTEN APPROVAL OF THE CHIEF EXECUTIVE OFFICER AND GENERAL COUNSEL OF VICOR CORPORATION. As used herein, life support devices or systems are devices which (a) are intended for surgical implant into the body, or (b) support or sustain life and whose failure to perform when properly used in accordance with instructions for use provided in the labeling can be reasonably expected to result in a significant injury to the user. A critical component is any component in a life support device or system whose failure to perform can be reasonably expected to cause the failure of the life support device or system or to affect its safety or effectiveness. Per Vicor Terms and Conditions of Sale, the user of Vicor products and components in life support applications assumes all risks of such use and indemnifies Vicor against all liability and damages.

Intellectual Property Notice

Vicor and its subsidiaries own Intellectual Property (including issued U.S. and Foreign Patents and pending patent applications) relating to the products described in this data sheet. No license, whether express, implied, or arising by estoppel or otherwise, to any intellectual property rights is granted by this document. Interested parties should contact Vicor's Intellectual Property Department.

The products described on this data sheet are protected by the following U.S. Patents Numbers:

5,945,130; 6,403,009; 6,710,257; 6,911,848; 6,930,893; 6,934,166; 6,940,013; 6,969,909; 7,038,917; 7,145,186; 7,166,898; 7,187,263; 7,202,646; 7,361,844; D496,906; D505,114; D506,438; D509,472; and for use under 6,975,098 and 6,984,965.

Vicor Corporation

25 Frontage Road
Andover, MA, USA 01810
Tel: 800-735-6200
Fax: 978-475-6715

email

Customer Service: custserv@vicorpower.com
Technical Support: apps@vicorpower.com

X-ON Electronics

Largest Supplier of Electrical and Electronic Components

Click to view similar products for [Switching Voltage Regulators](#) category:

Click to view products by [Vicor](#) manufacturer:

Other Similar products are found below :

[FAN53610AUC33X](#) [FAN53611AUC123X](#) [FAN48610BUC33X](#) [FAN48610BUC45X](#) [FAN48617UC50X](#) [R3](#) [430464BB](#) [KE177614](#)
[FAN53611AUC12X](#) [MAX809TTR](#) [NCV891234MW50R2G](#) [NCP81103MNTXG](#) [NCP81203PMNTXG](#) [NCP81208MNTXG](#)
[NCP81109GMNTXG](#) [SCY1751FCCT1G](#) [NCP81109JMNTXG](#) [AP3409ADNTR-G1](#) [NCP81241MNTXG](#) [LTM8064IY](#) [LT8315EFE#TRPBF](#)
[LTM4664EY#PBF](#) [LTM4668AIY#PBF](#) [NCV1077CSTBT3G](#) [XCL207A123CR-G](#) [MPM54304GMN-0002](#) [MPM54304GMN-0004](#)
[MPM54304GMN-0003](#) [AP62300Z6-7](#) [MP8757GL-P](#) [MIC23356YFT-TR](#) [LD8116CGL](#) [HG2269M/TR](#) [OB2269](#) [XD3526](#) [U6215A](#) [U6215B](#)
[U6620S](#) [LTC3412IFE](#) [LT1425IS](#) [MAX25203BATJA/VY+](#) [MAX77874CEWM+](#) [XC9236D08CER-G](#) [MP3416GJ-P](#) [BD9S201NUX-CE2](#)
[MP5461GC-Z](#) [MPQ4415AGQB-Z](#) [MPQ4590GS-Z](#) [MAX38640BENT18+T](#) [MAX77511AEWB+](#)