

Data Sheet

Customer :

Product : Thin Film Precision Chip Resistor - AR Series

Size: 0201/0402/0603/0805/1206/1210/2010/2512

Issued Date: 27-Apr-20

Edition : REV.F



VIKING TECH CORPORATION
光頡科技股份有限公司

No.70, Guangfu N. Rad.,
Hsin Chu Industrial Park,
Hukou Hsiang, Hsin Chu Hsien,
303, Taiwan

TEL:886-3-5972931

FAX:886-3-5972935•886-3-5973494

E-mail:sales@viking.com.tw

VIKING TECH CORPORATION KAOHSIUNG BRANCH
光頡科技股份有限公司高雄分公司

No.248-3, Sin-Sheng Rd., Cian-Jhen Dist., Kaohsiung,
806, Taiwan

TEL:886-7-8217999

FAX:886-7-8228229

E-mail:sales@viking.com.tw

Viking Electronics (WUXI) CO., LTD.
光頡電子(無錫)有限公司

No.1A,(Xixia Road),Machinery & Industry Park,
National Hi-Tech Industrial Development Zone of
Wuxi, Wuxi, Jiangsu Province, China

Zip Code:214028

TEL:86-510-85203339

FAX:86-510-85203667•86-510-85203977

E-mail:wuxisales@tmtec.com.tw

Produced by (QC)	Checked (QC)	Approved by (QC)	Prepared by (Sales)	Accepted by (Customer)
27-Apr-20	27-Apr-20	27-Apr-20	27-Apr-20	
Chun	Ben Chang	Ben Chang		

Thin Film Precision Chip Resistor (AR Series)

■ Features

- Advanced thin film technology
- Very tight tolerance down to $\pm 0.01\%$
- Extremely low TCR down to $\pm 1\text{PPM}/^\circ\text{C}$
- Wide resistance range 1ohm ~ 3Mega ohm
- Miniature size 0201 available

■ Applications

- Medical Equipment
- Testing / Measurement Equipment
- Printer Equipment
- Automatic Equipment Controller
- Converters
- Communication Device, Cell Phone, GPS, PDA



■ Construction

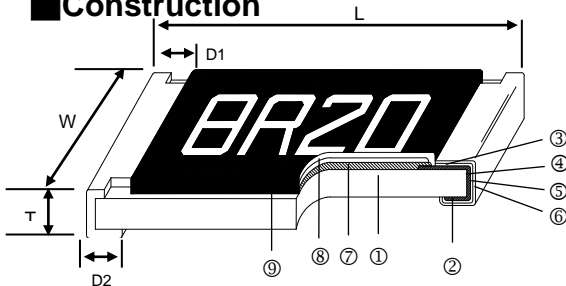

① Alumina Substrate	④ Edge Electrode	⑦ Resistor Layer
② Bottom Electrode	⑤ Barrier Layer	⑧ Overcoat
③ Top Electrode	⑥ External Electrode	⑨ Marking

■ Dimensions

Unit: mm

Type	Size (Inch)	L	W	T	D1	D2	Weight (g) (1000pcs)
AR01	0201	0.58 \pm 0.05	0.29 \pm 0.05	0.23 \pm 0.05	0.12 \pm 0.05	0.15 \pm 0.05	0.14
AR02	0402	1.00 \pm 0.05	0.50 \pm 0.05	0.30 \pm 0.05	0.20 \pm 0.10	0.20 \pm 0.10	0.54
AR03	0603	1.55 \pm 0.10	0.80 \pm 0.10	0.45 \pm 0.10	0.30 \pm 0.20	0.30 \pm 0.20	1.83
AR05	0805	2.00 \pm 0.15	1.25 \pm 0.15	0.55 \pm 0.10	0.30 \pm 0.20	0.40 \pm 0.20	4.71
AR06	1206	3.05 \pm 0.15	1.55 \pm 0.15	0.55 \pm 0.10	0.42 \pm 0.20	0.35 \pm 0.25	9.02
AR13	1210	3.10 \pm 0.15	2.40 \pm 0.15	0.55 \pm 0.10	0.40 \pm 0.20	0.55 \pm 0.25	10
AR10	2010	4.90 \pm 0.15	2.40 \pm 0.15	0.55 \pm 0.10	0.60 \pm 0.30	0.50 \pm 0.25	23.61
AR10(1/2W)	2010(1/2W)	4.90 \pm 0.15	2.40 \pm 0.15	0.55 \pm 0.10	0.60 \pm 0.30	2.20 \pm 0.25	26.68
AR12	2512	6.30 \pm 0.15	3.10 \pm 0.15	0.55 \pm 0.10	0.60 \pm 0.30	0.50 \pm 0.25	38.06
AR12(1W)	2512(1W)	6.30 \pm 0.15	3.10 \pm 0.15	0.55 \pm 0.10	0.60 \pm 0.30	2.50 \pm 0.25	44.65

■ Part Numbering

AR	03	T	T	B	Y	1001	N
Product Type	Dimensions (LxW)	Resistance Tolerance	Packaging Code	TCR (PPM/ $^\circ$ C)	Power Rating	Resistance	Marking Code
	01: 0201 02: 0402 03: 0603 05: 0805 06: 1206 13: 1210 10: 2010 12: 2512	T: $\pm 0.01\%$ A: $\pm 0.05\%$ B: $\pm 0.1\%$ C: $\pm 0.25\%$ D: $\pm 0.5\%$ F: $\pm 1\%$	T: Taping Reel B: Bulk	5: ± 1 X: ± 2 O: ± 3 S: ± 5 B: ± 10 N: ± 15 C: ± 25 D: ± 50	: Standard N: 1/20W Y: 1/16W X: 1/10W W: 1/8W M: 1/6W P: 1/5W V: 1/4W O: 1/3W U: 1/2W Q: 3/4W T: 1W	0010: 1 Ω 4R70: 4.7 Ω 1001: 1K Ω 1004: 1M Ω	: Standard Marking for E96 / E24 N: No Marking

Derating Curve

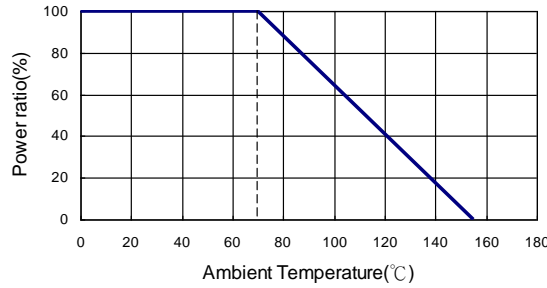

Standard Electrical Specifications

Item Type	Power Rating at 70°C	Operating Temp. Range	Max. Operating Voltage	Max. Overload Voltage	Resistance Range					TCR (PPM/°C)	
					±0.05%	±0.1%	±0.25%	±0.5%	±1%		
AR01 (0201)	1/32W	-55 ~ +155°C	15V	30V	—	49.9Ω - 75KΩ					±25,±50
AR02 (0402)	1/16W	-55 ~ +155°C	50V	100V	49.9Ω - 12KΩ	4Ω - 511KΩ					±25,±50
AR03 (0603)	1/16W	-55 ~ +155°C	50V	100V	4.7Ω - 332KΩ	1Ω - 1MΩ					±25,±50
AR05 (0805)	1/10W	-55 ~ +155°C	100V	200V	4.7Ω - 1MΩ	1Ω - 2MΩ					±25,±50
AR06 (1206)	1/8W	-55 ~ +155°C	150V	300V	4.7Ω - 1MΩ	1Ω - 2.5MΩ					±25,±50
AR13 (1210)	1/4W										
AR10 (2010)	1/4W										
AR12 (2512)	1/2W	-55 ~ +155°C	150V	300V	4.7Ω - 1MΩ	1Ω - 3MΩ					±25,±50

■ Lower Resistance: 1~10Ω

Special Electrical Specifications

Item Type	Power Rating at 70°C	Operating Temp. Range	Max. Operating Voltage	Max. Overload Voltage	Resistance Range						TCR (PPM/°C)
					±0.01%	±0.05%	±0.1%	±0.25%	±0.5%	±1%	
AR02 (0402)	1/16W	-55 ~ +155°C	50V	100V	49.9Ω - 4.99KΩ		—				±1, ±2, ±3
					49.9Ω - 20KΩ						±5
					49.9Ω - 20KΩ		49.9Ω - 100KΩ				±10, ±15
AR03 (0603)	1/16W	-55 ~ +155°C	50V	100V	24.9Ω - 15KΩ		—				±1, ±2, ±3
					24.9Ω - 60KΩ						±5
					24.9Ω - 100KΩ	4.7Ω - 332KΩ	4.7Ω - 511KΩ				±10, ±15
AR05 (0805)	1/10W	-55 ~ +155°C	100V	200V	24.9Ω - 30KΩ		—				±1, ±2, ±3
					24.9Ω - 150KΩ						±5
					24.9Ω - 200KΩ	4.7Ω - 1MΩ				±10, ±15	
AR06 (1206)	1/8W	-55 ~ +155°C	150V	300V	24.9Ω - 49.9KΩ		—				±1, ±2, ±3
					24.9Ω - 300KΩ						±5
					24.9Ω - 499KΩ	4.7Ω - 1.5MΩ				±10, ±15	
AR13 (1210)	1/ 4W	-55 ~ +155°C	150V	300V	24.9Ω - 49.9KΩ		—				±1, ±2, ±3
					24.9Ω - 300KΩ						±5
					24.9Ω - 499KΩ	4.7Ω - 1MΩ				±10, ±15	
AR10 (2010)	1/4W	-55 ~ +155°C	150V	300V	24.9Ω - 100KΩ		—				±1, ±2, ±3
					24.9Ω - 300KΩ						±5
					24.9Ω - 499KΩ	4.7Ω - 1MΩ				±10, ±15	
AR12 (2512)	1/2W	-55 ~ +155°C	150V	300V	24.9Ω - 100KΩ		—				±1, ±2, ±3
					24.9Ω - 300KΩ						±5
					24.9Ω - 499KΩ	4.7Ω - 1MΩ				±10, ±15	

High Power Rating Electrical Specifications

Item Type	Power Rating at 70°C	Operating Temp. Range	Max. Operating Voltage	Max. Overload Voltage	Resistance Range						TCR (PPM/°C)
					±0.01%	±0.05%	±0.1%	±0.25%	±0.5%	±1%	
AR01 (0201)	1/20W	-55 ~ +155°C	25V	50V	—		5KΩ - 75KΩ				±25,±50
AR02 (0402)	1/10W	-55 ~ +155°C	50V	100V	49.9Ω - 4.99KΩ			—			±1, ±2,±3
					49.9Ω - 20KΩ						±5
					49.9Ω - 12KΩ			49.9Ω - 100KΩ			±10, ±15
					—	49.9Ω - 12KΩ	4.7Ω ~255KΩ			±25,±50	
AR03 (0603)	1/10W	-55 ~ +155°C	75V	150V	24.9Ω - 15KΩ			—			±1, ±2,±3
					24.9Ω - 60KΩ						±5
					24.9Ω - 100KΩ	4.7Ω - 332KΩ	4.7Ω - 511KΩ			±10,±15	
	—	—	1Ω - 1MΩ			±25,±50					
	1/6W	-55 ~ +155°C	100V	150V	—	10Ω - 332KΩ				±25,±50	
AR05 (0805)	1/8W	-55 ~ +155°C	150V	300V	24.9Ω - 30KΩ			—			±1, ±2,±3
					24.9Ω - 150KΩ						±5
					24.9Ω - 200KΩ	4.7Ω - 511KΩ	4.7Ω - 1MΩ			±10, ±15	
	—	—	1Ω - 1MΩ			±25,±50					
	1/4W	-55 ~ +155°C	150V	300V	—	10Ω - 499KΩ				±25,±50	
AR06 (1206)	1/4W	-55 ~ +155°C	200V	400V	24.9Ω - 49.9KΩ			—			±1, ±2,±3
					24.9Ω - 300KΩ						±5
					24.9Ω - 499KΩ	4.7Ω - 1MΩ			±10,±15		
	—	1Ω - 1MΩ			±25,±50						
	1/3W	-55 ~ +155°C	200V	400V	—	10Ω ~1MΩ				±25,±50	
AR13 (1210)	1/ 3W	-55 ~ +155°C	200V	400V	24.9Ω - 49.9KΩ			—			±1, ±2,±3
					24.9Ω - 300KΩ						±5
					24.9Ω - 499KΩ	4.7Ω - 1MΩ			±10,±15		
					—	1Ω - 1MΩ			±25,±50		
AR10(2010)	1/3W	-55 ~ +155°C	200V	400V	24.9Ω - 49.9KΩ			—			±1, ±2,±3
					24.9Ω - 300KΩ						±5
					24.9Ω - 499KΩ	4.7Ω - 1MΩ			±10,±15		
	—	1Ω - 1MΩ			±25,±50						
	1/2W	-55 ~ +155°C	200V	400V	24.9Ω - 2KΩ	4.7Ω - 1MΩ	1Ω - 1MΩ		±10,±15,±25,±50		
AR12(2512)	3/4W	-55 ~ +155°C	200V	400V	24.9Ω - 2KΩ	4.7Ω - 2KΩ	1Ω - 2KΩ		±10,±15,±25,±50		
	1W	-55 ~ +155°C	200V	400V	24.9Ω - 2KΩ	4.7Ω - 1MΩ	1Ω - 1MΩ		±10,±15,±25,±50		

Operating Voltage= $\sqrt{P \cdot R}$ or Max. operating voltage listed above, whichever is lower.
 Overload Voltage= $2.5 \cdot \sqrt{P \cdot R}$ or Max. overload voltage listed above, whichever is lower.

■Viking is capable of manufacturing the optional spec based on customer's requirement.
(Lower Resistance:1~10Ω ; High Power Rating)

Environmental Characteristics

Item	Requirement		Test Method
	Tol. ≤ 0.05%	Tol. > 0.05%	
Temperature Coefficient of Resistance (T.C.R.)	As Spec.		MIL-STD-202 Method 304 +25/-55/+25/+125/+25°C
Short Time Overload	ΔR±0.05%	ΔR±0.2%	JIS-C-5201-1 4.13 RCWV*2.5 or Max. overload voltage whichever is lower for 5 seconds
	ΔR±0.2% for high power rating		
Insulation Resistance	>9999 MΩ		MIL-STD-202 Method 302 Apply 100V _{DC} for 1 minute
Endurance	ΔR±0.05%	ΔR±0.2%	MIL-STD-202 Method 108A 70±2°C, RCWV for 1000 hrs with 1.5 hrs "ON" and 0.5 hrs "OFF"
	ΔR±0.5% for high power rating		
	0201: >7kΩ → ΔR±0.5% ≤7kΩ → ΔR±0.2%		
Damp Heat with Load	ΔR±0.05%	ΔR±0.3%	MIL-STD-202 Method 103B 40±2°C, 90~95% R.H. RCWV for 1000 hrs with 1.5 hrs "ON" and 0.5 hrs "OFF"
	ΔR±0.5% for high power rating		
Bending Strength	ΔR±0.05%	ΔR±0.1%	JIS-C-5201-1 4.33 Bending amplitude 3 mm for 10 seconds 2010 2512 sizes: 2 mm Other sizes: 3 mm
Solderability	95% min. coverage		MIL-STD-202 Method 208H 245±5°C for 3 seconds
Resistance to Soldering Heat	ΔR±0.05%	ΔR±0.1%	MIL-STD-202 Method 210E 260±5°C for 10 seconds
Dielectric Withstand Voltage	By Type		MIL-STD-202 Method 301 Max. overload voltage for 1 minute
Low Temperature Operation	ΔR±0.05%	ΔR±0.2%	JIS-C-5201-1 4.36 1 hour, -65°C, followed by 45 minutes of RCWV
	ΔR±0.5% for high power rating		
High Temperature Exposure	ΔR±0.5%		MIL-STD-202 Method 108 at +155°C for 1000 hrs

RCWV(Rated continuous working voltage)= $\sqrt{P \cdot R}$ or Max. Operating voltage whichever is lower

■ Storage Temperature: 15~28°C; Humidity < 80%RH

Soldering Condition

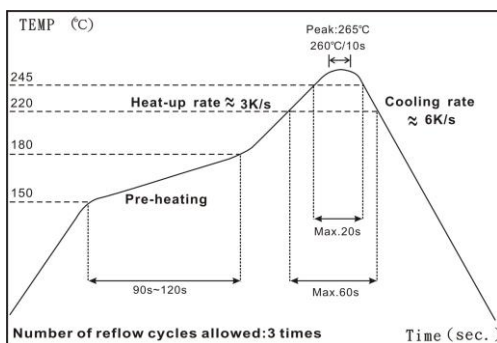

IR Reflow Soldering

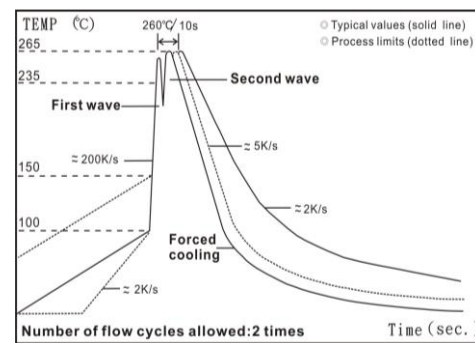

Wave Soldering (Flow Soldering)

- (1) Time of IR reflow soldering at maximum temperature point 260°C : 10s
- (2) Time of wave soldering at maximum temperature point 260°C : 10s
- (3) Time of soldering iron at maximum temperature point 410°C : 5s

■ Marking

0603 3digit marking



3digit marking for Example: 14C=13K7Ω 13C=13K3Ω
68B=4K99Ω 68X=49.9Ω

Marking Table

Code	E96	Code	E96	Code	E96	Code	E96				
01	100	25	178	49	316	73	562				
02	102	26	182	50	324	74	576				
03	105	27	187	51	332	75	590				
04	107	28	191	52	340	76	604				
05	110	29	196	53	348	77	619				
06	113	30	200	54	357	78	634				
07	115	31	205	55	365	79	649				
08	118	32	210	56	374	80	665				
09	121	33	215	57	383	81	681				
10	124	34	221	58	392	82	698				
11	127	35	226	59	402	83	715				
12	130	36	232	60	412	84	732				
13	133	37	237	61	422	85	750				
14	137	38	243	62	432	86	768				
15	140	39	249	63	442	87	787				
16	143	40	255	64	453	88	806				
17	147	41	261	65	464	89	825				
18	150	42	267	66	475	90	845				
19	154	43	274	67	487	91	866				
20	158	44	280	68	499	92	887				
21	162	45	287	69	511	93	909				
22	165	46	294	70	523	94	931				
23	169	47	301	71	536	95	953				
24	174	48	309	72	549	96	976				
Code	A	B	C	D	E	F	G	H	X	Y	Z
Multiplier	10 ⁰	10 ¹	10 ²	10 ³	10 ⁴	10 ⁵	10 ⁶	10 ⁷	10 ⁻¹	10 ⁻²	10 ⁻³

0603 3digit marking for E24

Example: 101=100Ω 102=1KΩ

E24	10	11	12	13	15	16	18	20	22	24	27	30	33	36	39	43	47	51	56	62	68	75	82	91
-----	----	----	----	----	----	----	----	----	----	----	----	----	----	----	----	----	----	----	----	----	----	----	----	----

0805-2512 4digit marking

Example

Resistance	100Ω	2.2KΩ	10KΩ	49.9KΩ	100KΩ
marking	1000	2201	1002	4992	1003

■Packaging

Packing Quantity & Reel Specifications

Unit :mm

Type	ØA	ØB	ØC	W	T	Paper Tape (EA)	Emboss Plastic Tape (EA)
AR01	178.0±1.0	60.0±1.0	13.5±0.7	9.5±1.0	11.5±1.0	10,000	-
AR02	178.0±1.0	60.0±1.0	13.5±0.7	9.5±1.0	11.5±1.0	10,000	-
AR03	178.0±1.0	60.0±1.0	13.5±0.7	9.5±1.0	11.5±1.0	5,000	-
AR05	178.0±1.0	60.0±1.0	13.5±0.7	9.5±1.0	11.5±1.0	5,000	-
AR06	178.0±1.0	60.0±1.0	13.5±0.7	9.5±1.0	11.5±1.0	5,000	-
AR13	178.0±1.0	60.0±1.0	13.5±0.7	9.5±1.0	11.5±1.0	5,000	-
AR10	178.0±1.0	60.0±1.0	13.5±0.7	13.5±1.0	15.5±1.0	-	4,000
AR12	178.0±1.0	60.0±1.0	13.5±0.7	13.5±1.0	15.5±1.0	-	4,000



Paper Tape Specifications



Unit: mm

Type	A	B	W	E	F	P ₀	P ₁	P ₂	ΦD ₀	T
AR01	0.40±0.05	0.70±0.05	8.00±0.10	1.75±0.05	3.5±0.05	4.00±0.10	2.00±0.05	2.00±0.05	1.55±0.03	0.42±0.02
AR02	0.70±0.05	1.16±0.05	8.00±0.10	1.75±0.05	3.5±0.05	4.00±0.10	2.00±0.05	2.00±0.05	1.55±0.05	0.40±0.03
AR03	1.10±0.05	1.90±0.05	8.00±0.10	1.75±0.05	3.5±0.05	4.00±0.10	4.00±0.10	2.00±0.05	1.55±0.05	0.60±0.03
AR05	1.60±0.05	2.37±0.05	8.00±0.10	1.75±0.05	3.5±0.05	4.00±0.10	4.00±0.10	2.00±0.05	1.55±0.05	0.75±0.05
AR06	2.00±0.05	3.55±0.05	8.00±0.10	1.75±0.05	3.5±0.05	4.00±0.10	4.00±0.10	2.00±0.05	1.55±0.05	0.75±0.05
AR13	2.75±0.05	3.40±0.05	8.00±0.10	1.75±0.05	3.5±0.05	4.00±0.05	4.00±0.10	2.00±0.05	1.60±0.10	0.75±0.05

- Peel force of top cover tape
- The peel speed shall be about 300mm/min±5%
- The peel force of top cover tape shall be between 8gf to 60gf

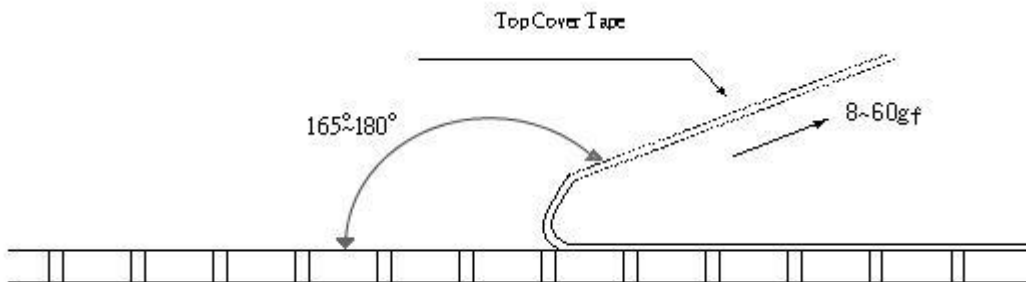

Emboss Plastic Tape Specifications

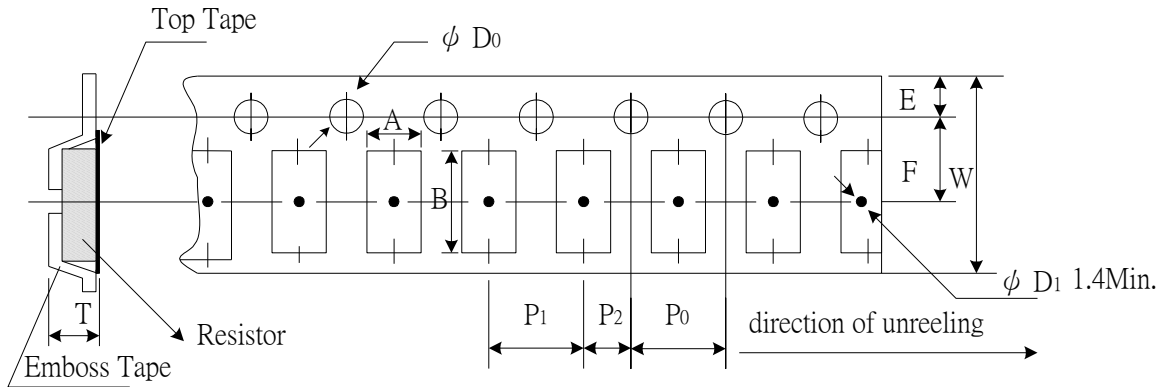

Unit: mm

Type	A	B	W	E	F	P ₀	P ₁	P ₂	ØD ₀	T
AR10	2.85±0.10	5.45±0.10	12.0±0.10	1.75±0.10	5.5±0.05	4.00±0.05	4.00±0.10	2.00±0.05	1.50±0.10	1.00±0.20
AR12	3.40±0.10	6.65±0.10	12.0±0.10	1.75±0.10	5.5±0.05	4.00±0.05	4.00±0.10	2.00±0.05	1.50±0.10	1.00±0.20

- Peel force of top cover tape
- The peel speed shall be about 300mm/min±5%
- The peel force of top cover tape shall be between 20gf to 80gf



Recommend Land Pattern

Unit: mm

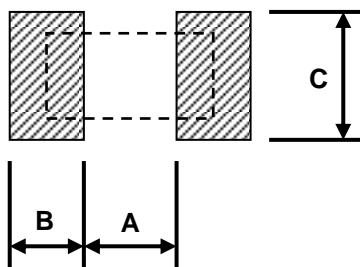

Type	A	B	C
AR01	0.25	0.30	0.40±0.2
AR02	0.50	0.50	0.60±0.2
AR03	0.80	1.00	0.90±0.2
AR05	1.00	1.00	1.35±0.2
AR06	2.00	1.15	1.70±0.2
AR13	2.00	1.15	2.50±0.2
AR10	3.60	1.40	2.50±0.2
AR10(1/2W)	1.00	2.70	2.50±0.2
AR12	4.90	1.60	3.10±0.2
AR12(1W)	1.00	3.55	3.10±0.2

REVISION HISTORY

REVISION	DATE	CHANGE NOTIFICATION	DESCRIPTION
Version D3	Jan. 14, 2013	-	<ul style="list-style-type: none">- Add resistance range for Special Electrical and High Power Rating Electrical Specifications.- Adjust the mockup.
Version D4	Apr. 10, 2013	-	<ul style="list-style-type: none">- Add "RCWV" description in Environment Characteristic Test Method.
Version D5	Oct. 16, 2013	-	<ul style="list-style-type: none">- Increase the resistance range of AR05, TCR15 product.
Version D6	Oct. 17, 2014	-	<ul style="list-style-type: none">- Correct the specification of top cover tape peel force.- Update the resistance range of AR05 (Standard) to 4.7Ω -1MΩ
Version D7	Apr. 28, 2015	-	<ul style="list-style-type: none">- Add TCR ±2ppm and ±3ppm products specification.- Increase the resistance range of the products below:<ul style="list-style-type: none">• AR02 and AR03 of Standard Electrical Specifications.• AR02, AR03 and AR05 of Special Electrical Specifications.- Correct the element of Top Electrode.
Version D8	May. 02, 2016	-	<ul style="list-style-type: none">- Modify Storage Temperature.
Version D9	Aug.04, 2016	-	<ul style="list-style-type: none">- Update items and requirements of Environmental Characteristics.- Increase the resistance range of Special Electrical Specifications products.
Version E	Dec.14, 2016	-	<ul style="list-style-type: none">- Add AR02 High Power Rating Electrical Specifications.

REVISION HISTORY

REVISION	DATE	CHANGE NOTIFICATION	DESCRIPTION
Version E1	Feb. 23, 2017	-	- Increase the resistance range of AR02 Standard Electrical Specifications.
Version E2	Apr. 05, 2017	-	- Add TCR ± 1 ppm and products specification.
Version E3	Nov.10, 2017	-	- Correct the reference standard in Environmental Characteristics.
Version E4	Dec.26, 2017	-	- Correct the reference standard in Environmental Characteristics.
Version E5	Feb. 06, 2018	-	- Correct the reference standard in Environmental Characteristics.
Version E6	Jul. 24, 2018	-	- Update Environment Characteristics item.
Version E7	May. 02,2019	-	- Increase the AR01 0.1% & 0.25% Precision resistance.
Version E8	Oct. 29,2019	-	- Increase the resistance range of Standard, Special and High Power Rating Electrical Specifications.
Version E9	Jan. 07,2020	-	<ul style="list-style-type: none"> - Define the Dimensions specifications for AR10(1/2W) and AR12(1W). - Add the part number code "N" for 1/20W Power rating. - Extend the resistance range of AR01 (Standard Electrical Specifications). - Add products specifications for AR01(1/20W) and AR10(1/2W). - Update products specifications for AR12(1W). - Define the Recommend Land Pattern for AR10(1/2W) and AR12(1W).
Version F	Apr. 27,2020	-	<ul style="list-style-type: none"> - Modify the Max. Operating Voltage of AR02 from 25V to 50V. - Modify the Max. Overload Voltage of AR02 from 50V to 100V. - Correct Recommend Land Pattern Dimension A/B of AR10(1/2W) from 0.5mm/2.8mm to 1.00mm/2.70mm.

X-ON Electronics

Largest Supplier of Electrical and Electronic Components

Click to view similar products for [Thick Film Resistors - SMD category](#):

Click to view products by [Viking manufacturer](#):

Other Similar products are found below :

[CR-05FL7--150R](#) [CR-05FL7--698K](#) [CR-12FP4--324R](#) [CR-12JP4--680R](#) [M55342K06B10D0RS6](#) [M55342K06B14E0RS6](#)
[M55342K06B1E78RS3](#) [M55342K06B24E9RS6](#) [M55342K06B6E19RWL](#) [M55342K06B6E81RS3](#) [M55342M05B200DRWB](#)
[M55342M06B4K70MS3](#) [MC0603-511-JTW](#) [742C083750JTR](#) [MCR01MZPF1202](#) [MCR01MZPF1601](#) [MCR01MZPF1800](#)
[MCR01MZPF6201](#) [MCR01MZPF9102](#) [MCR01MZPJ113](#) [MCR01MZPJ121](#) [MCR01MZPJ125](#) [MCR01MZPJ751](#) [MCR03EZHZ103](#)
[MCR03EZPF2004](#) [MCR03EZPJ270](#) [MCR03EZPJ821](#) [MCR10EZPF1102](#) [MCR10EZPF2700](#) [MCR18EZPJ330](#) [RC1005F1152CS](#)
[RC1005F1182CS](#) [RC1005F1372CS](#) [RC1005F183CS](#) [RC1005F1911CS](#) [RC1005F1912CS](#) [RC1005F203CS](#) [RC1005F2052CS](#)
[RC1005F241CS](#) [RC1005F2431CS](#) [RC1005F3011CS](#) [RC1005F303CS](#) [RC1005F4321CS](#) [RC1005F4642CS](#) [RC1005F471CS](#)
[RC1005F4751CS](#) [RC1005F5621CS](#) [RC1005F6041CS](#) [RC1005J106CS](#) [RC1005J121CS](#)