

Data Sheet

Customer:

Product: Metal Film Precision Resistor-CSR Series

Size: 0204/ 0207

Issued Date: 01-Jun-17

Edition: REV.C4



VIKING TECH CORPORATION
光頤科技股份有限公司
No.70 Guangfu N. Rd., Hukou
Township, Hsinchu County 303,
Taiwan

TEL:886-3-5972931
FAX:886-3-5972935•886-3-5973494
E-mail:sales@viking.com.tw

VIKING TECH CORPORATION KAOHSIUNG BRANCH
光頤科技股份有限公司高雄分公司
No.248-3, Sin-Sheng Rd., Cian-Jhen Dist., Kaohsiung,
806, Taiwan

TEL:886-7-8217999
FAX:886-7-8228229
E-mail:sales@viking.com.tw

WUXI TMTEC CO., LTD.
無錫泰銘電子有限公司
No.22 Xixia Road, Machinery & Industry Park,
National Hi-Tech Industrial Development Zone
of Wuxi, Wuxi, Jiangsu Province, China
Zip Code:214028
TEL:86-510-85203339
FAX:86-510-85203667•86-510-85203977
E-mail:china@viking.com.tw

Produced by (QC)	Checked (QC)	Approved by (QC)	Prepared by (Sales)	Accepted by (Customer)
01-Jun-17	01-Jun-17	01-Jun-17	01-Jun-17	
Susan Huang	J.C. Liu	J.C. Liu		

Metal Film Precision Resistor
Metal Film Precision Resistor



■Features

- Excellent overall stability
- Tight tolerance down to $\pm 0.1\%$
- Extremely low TCR down to ± 10 PPM/ $^{\circ}$ C
- High power rating up to 1 Watts

■Applications

- Telecommunication
- Medical Equipment
- Measurement/Testing Equipment

■Construction & Dimension

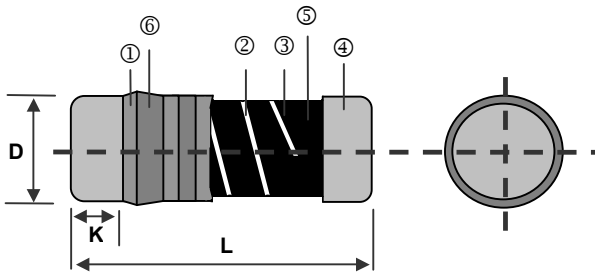

① Insulation Coating	④ Electrode Cap
② Trimming Line	⑤ Resistor Layer
③ Ceramic Rod	⑥ Marking

Type	L (mm)	Φ D (mm)	K (mm)	Weight 1,000EA (g)
CSR0204	3.50 \pm 0.20	1.40 \pm 0.15	0.8 \pm 0.1	18.7
CSR0207	5.90 \pm 0.20	2.20 \pm 0.20	1.3 \pm 0.1	80.9

■Derating Curve

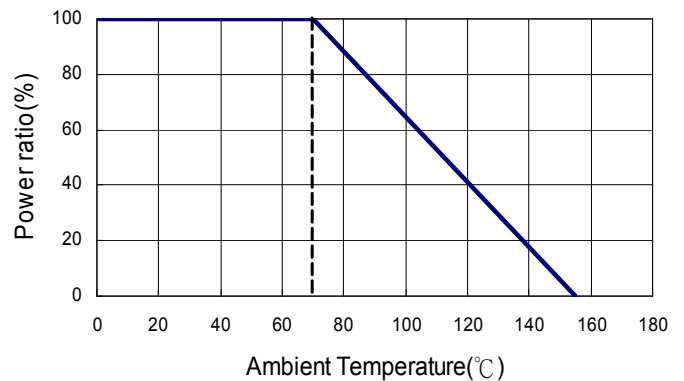

■Part Numbering

CSR	0204	D	T	D	V	1000
Product Type	Dimensions (L \times Φ D)	Resistance Tolerance	Packaging Code	TCR (PPM/ $^{\circ}$ C)	Power Rating	Resistance
	0204: 3.5x1.4 0207: 5.9x2.2	B: $\pm 0.1\%$ C: $\pm 0.25\%$ D: $\pm 0.5\%$ F: $\pm 1\%$ J: $\pm 5\%$	T: Taping Reel	B: ± 10 N: ± 15 C: ± 25 D: ± 50 E: ± 100 - : No Specified	T: 1W U: 1/2W V: 1/4W G: 2/5W	0010: 1 Ω 0100: 10 Ω 1000: 100 Ω 2201: 2200 Ω 1001: 1K Ω 1004: 1M Ω R0R0: 0 Ω R050: 0.05 Ω R100: 0.1 Ω 22R1: 22.1 Ω

** Letter "R" is a decimal point.

Metal Film Precision Resistor

■ Soldering Condition

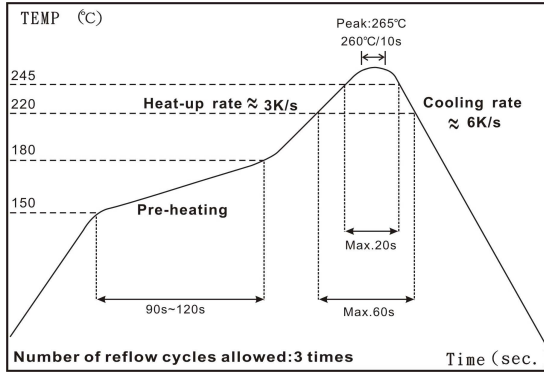

IR Reflow Soldering

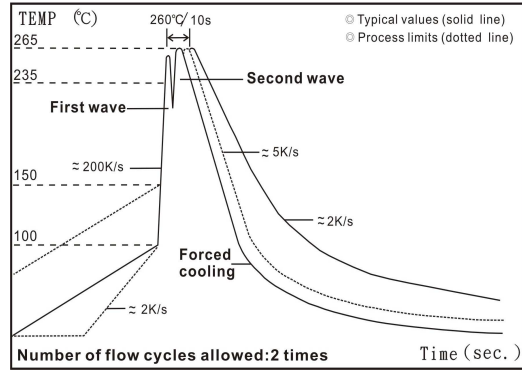

Wave Soldering (Flow Soldering)

- (1) Time of IR reflow soldering at maximum temperature point 260°C : 10s
- (2) Time of wave soldering at maximum temperature point 260°C : 10s
- (3) Time of soldering iron at maximum temperature point 410°C : 5s

■ Standard Electrical Specifications

Item Type	Power Rating at 70°C	Operating Temp. Range	Max. Operating Voltage	Max. Overload Voltage	Resistance Range					TCR (PPM/°C)
					±0.1%	±0.25%	±0.5%	±1%	±5%	
0204	1/4W Jumper:2A	-55 ~ +155°C	200V	400V	10Ω-20KΩ					±10
					10Ω-300KΩ					±15
					10Ω-1MΩ			4.02Ω-4.7MΩ		±25
					10Ω-1MΩ	1Ω-1MΩ	0.2Ω-10MΩ		±50	
					-			0.1Ω-10MΩ		±100
0Ω(<15mΩ)					-					
0207	1/2W Jumper:4A	-55 ~ +155°C	300V	600V	10Ω-20KΩ					±10
					10Ω-300KΩ					±15
					10Ω-1MΩ			4.02Ω-4.7MΩ		±25
					10Ω-1MΩ	1Ω-1MΩ	0.2Ω-10MΩ		±50	
					-			0.1Ω-10MΩ		±100
0Ω(<15mΩ)					-					

■ High Power Rating Electrical Specifications

Item Type	Power Rating at 70°C	Operating Temp. Range	Max. Operating Voltage	Max. Overload Voltage	Resistance Range					TCR (PPM/°C)
					±0.1%	±0.25%	±0.5%	±1%	±5%	
0204	2/5W	-55 ~ +155°C	200V	400V	10Ω-100KΩ					±15
					10Ω-1MΩ			4.02Ω-1MΩ		±25
					10Ω-1MΩ	1Ω-1MΩ	0.2Ω-1MΩ		±50	
					-			0.1Ω-1MΩ		±100
0207	1W	-55 ~ +155°C	350V	700V	10Ω-100KΩ					±15
					10Ω-1MΩ			4.02Ω-1MΩ		±25
					10Ω-1MΩ	1Ω-1MΩ	0.2Ω-10MΩ		±50	
					-			0.1Ω-10MΩ		±100

Operating Voltage= $\sqrt{P \cdot R}$ or Max. Operating Voltage listed above, whichever is lower.
 Overload Voltage= $2.5 \cdot \sqrt{P \cdot R}$ or Max. Overload Voltage listed above, whichever is lower.

■ Viking is capable of manufacturing the optional spec based on customer's requirement.

■ Environmental Characteristics

Item	Requirement	Test Method
Temperature Coefficient of Resistance (T.C.R.)	As Spec	JIS-C-5201-1 4.8 IEC-60115-1 4.8 -55°C~+125°C, 25°C is the reference temperature
Short Time Overload	$\pm(0.15\%+0.05\Omega)$	JIS-C-5201-1 4.13 IEC-60115-1 4.13 RCWV*2.5 or Max. Overload Voltage whichever is lower for 5 seconds
Insulation Resistance	$\geq 10G$	JIS-C-5201-1 4.6 IEC-60115-1 4.6 Max. Overload Voltage for 1 minute
Endurance	$\pm(0.5\%+0.05\Omega)$	JIS-C-5201-1 4.25 IEC-60115-1 4.25.1 70 \pm 2°C, RCWV for 1000 hrs with 1.5 hrs "ON" and 0.5 hr "OFF"
Damp Heat with Load	$\pm(1.0\%+0.05\Omega)$	JIS-C-5201-1 4.24 IEC-60115-1 4.24 40 \pm 2°C, 90~95% R.H., RCWV for 1000 hrs with 1.5 hrs "ON" and 0.5 hr "OFF"
Dry Heat	$\pm(1.0\%+0.05\Omega)$	JIS-C-5201-1 4.23 IEC-60115-1 4.23.2 at +155°C for 1000 hrs
Bending Strength	$\pm(0.5\%+0.05\Omega)$	JIS-C-5201-1 4.33 IEC-60115-1 4.33 Bending once for 5 seconds with 2mm
Solderability	95% min. coverage	JIS-C-5201-1 4.17 IEC-60115-1 4.17 245 \pm 5°C for 3 seconds
Resistance to Soldering Heat	$\pm(0.5\%+0.05\Omega)$	JIS-C-5201-1 4.18 IEC-60115-1 4.18 260 \pm 5°C for 10 seconds
Voltage Proof	No breakdown or flashover	JIS-C-5201-1 4.7 IEC-60115-1 4.7 1.42 times Max. Operating Voltage for 1 minute
Leaching	Individual leaching area $\leq 5\%$ Total leaching area $\leq 10\%$	JIS-C-5201-1 4.18 IEC-60068-2-58 8.2.1 260 \pm 5°C for 30 seconds
Rapid Change of Temperature	$\pm(0.5\%+0.05\Omega)$	JIS-C-5201-1 4.19 IEC-60115-1 4.19 -55°C to +155°C, 5 cycles

RCWV(Rated Continuous Working Voltage)= $\sqrt{P \cdot R}$ or Max. Operating Voltage whichever is lower.

■ Storage Temperature: 15~28°C; Humidity < 80%RH

Metal Film Precision Resistor

■ Packaging

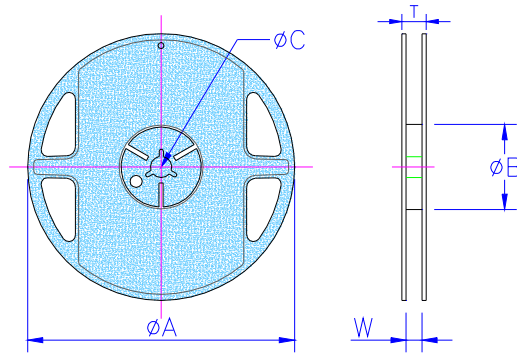

Packaging Quantity & Reel Specifications

Type	Reel Diameter	ΦA (mm)	ΦB (mm)	ΦC (mm)	W (mm)	T (mm)	Emboss Plastic Tape (EA)
CSR0204	7 inch	178.5±1.5	60.0+1.0	13.0±0.2	9.0±0.5	12.5±0.5	3,000
CSR0207	7 inch	178.5±1.5	60.0+1.0	13.0±0.5	13.0±0.5	15.5±0.5	2,000

Emboss Plastic Tape Specifications

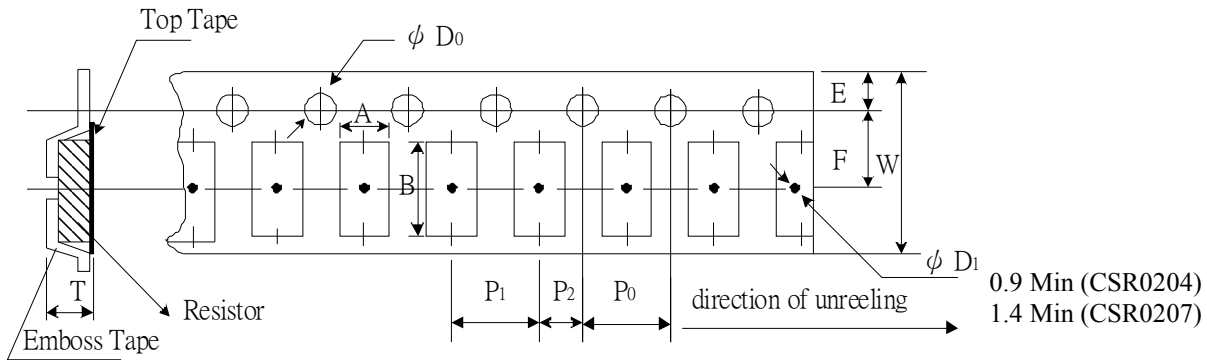

Type	A (mm)	B (mm)	W (mm)	E (mm)	F (mm)	P_0 (mm)	P_1 (mm)	P_2 (mm)	ΦD_0 (mm)	T (mm)
CSR0204	1.55±0.10	3.65±0.10	8.0±0.10	1.75±0.10	3.50±0.05	4.00±0.10	4.00±0.10	2.00±0.05	1.50+0.10	1.80±0.10
CSR0207	2.40±0.10	6.15±0.10	12.0±0.10	1.75±0.10	5.50±0.05	4.00±0.10	4.00±0.10	2.00±0.05	1.50+0.10	2.70±0.10

■ Recommend Land Pattern

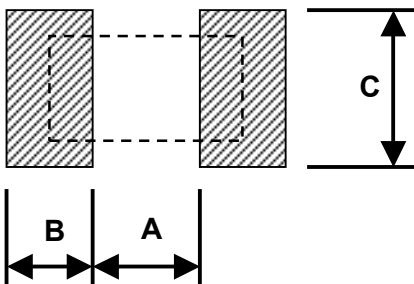

Type	A (mm)	B (mm)	C (mm)
CSR0204	1.6	1.2	1.6
CSR0207	3.0	1.7	2.4

■ Pulse withstanding capacity

The single impulse graph is the result of 50 impulses of rectangular shape applied at one-minute intervals. The limit of acceptance was a shift in resistance of less than 1% from the initial value. The power applied was subject to the restrictions of the maximum permissible impulse voltage graph shown.

CSR Series Single Pulse(100 Ohm)

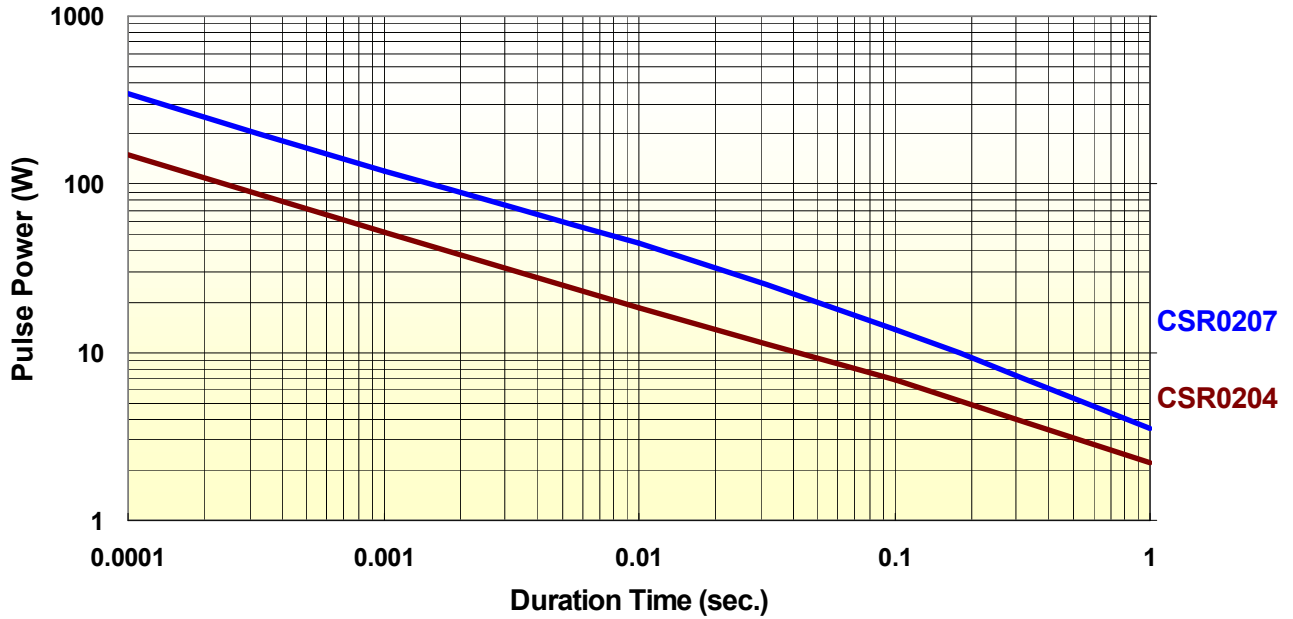

Continuous Pulse

The continuous load graph was obtained by applying repetitive rectangular pulses where the pulse period was adjusted so that the average power dissipated in the resistor was equal to its rated power at 70°C. Again the limit of acceptance was a shift in resistance of less than 1% from the initial value.

CSR Series Continuous Pulse(100 Ohm)

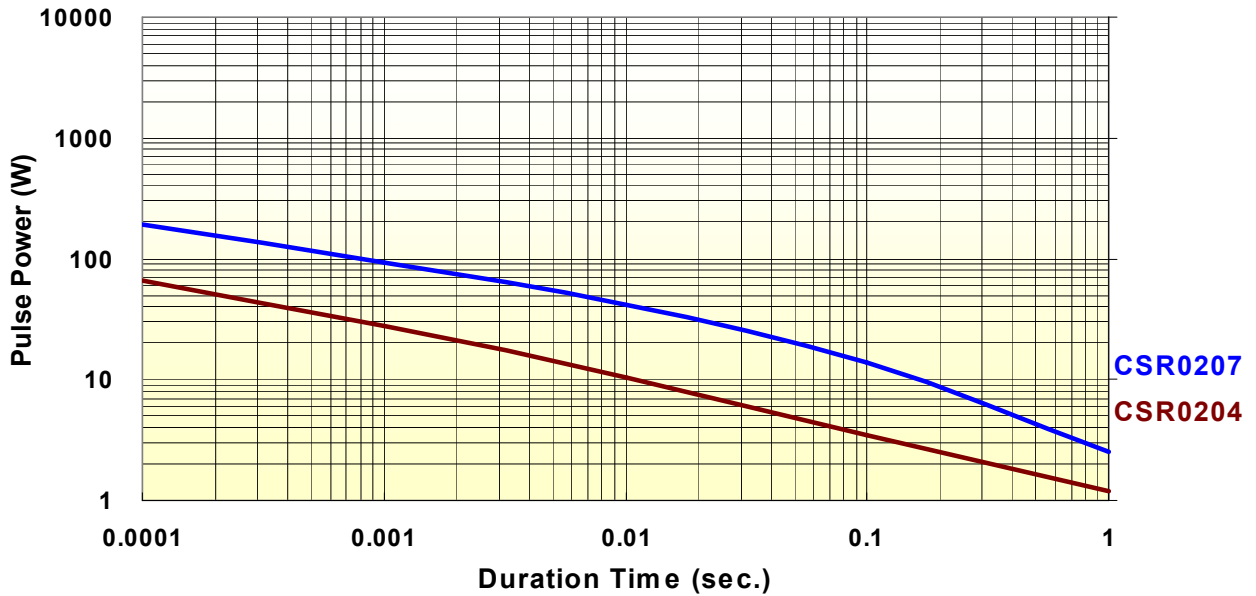

CSR Series Pulse Voltage(100 Ohm)

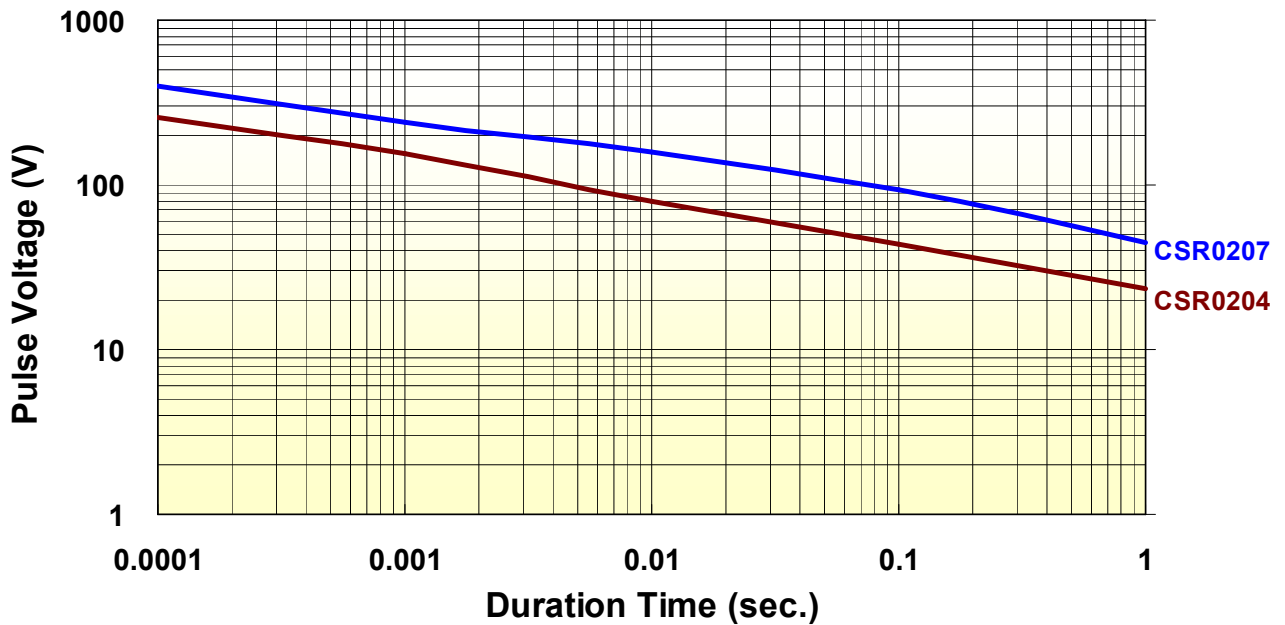

Frequency behavior

Resistors are designed to function according to ohmic laws. This is basically true of resistors for frequencies up to 100kHz. At higher frequencies, there is an additional contribution to the impedance by an ideal resistor switched in series with a coil and both switched parallel to a capacitor. The values of the capacitance and inductance are mainly determined by the dimensions of the terminations and the conductive path length.

The environment surrounding components has a large influence on the behavior of the component on the printed-circuit board.

**Frequency vs. Impedance
CSR Series(CSR0204)**

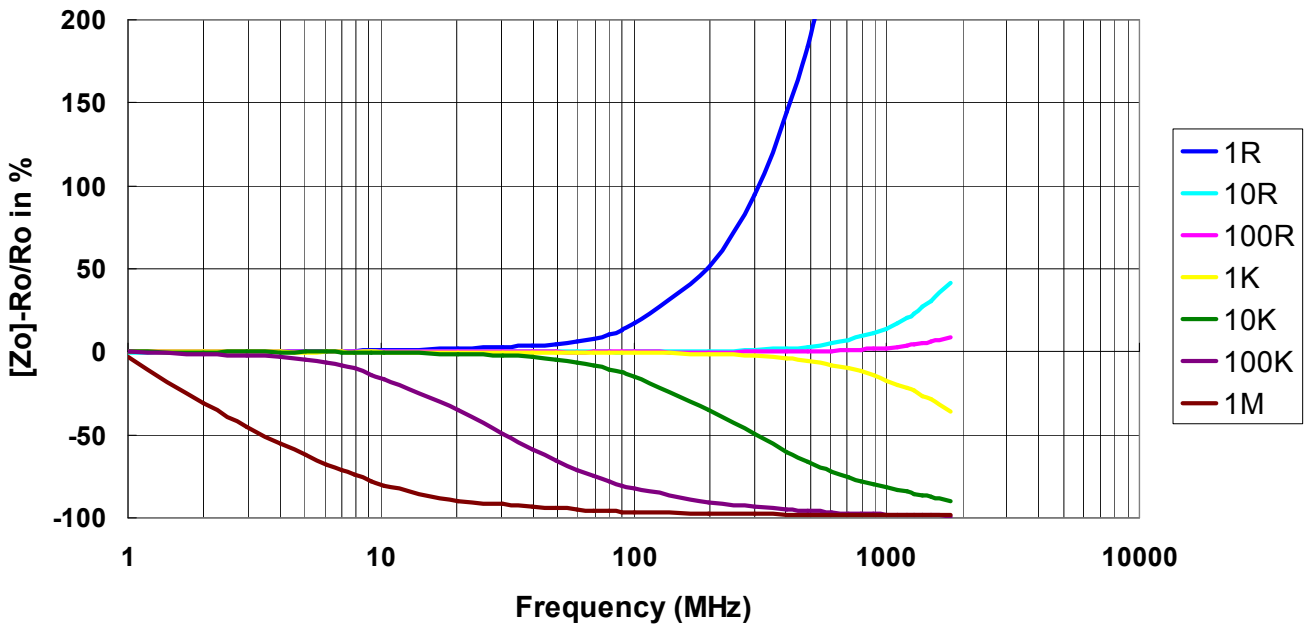

**Frequency vs. Phase Angle
CSR Series(CSR0204)**

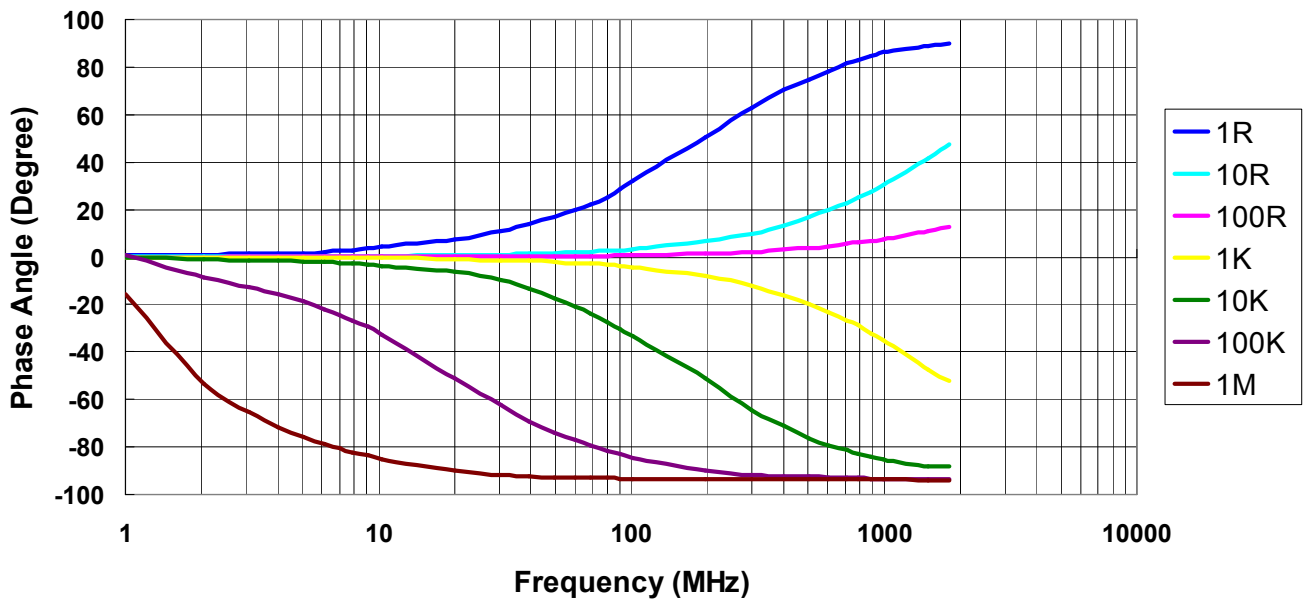

Frequency vs. Impedance CSR Series(CSR0207)

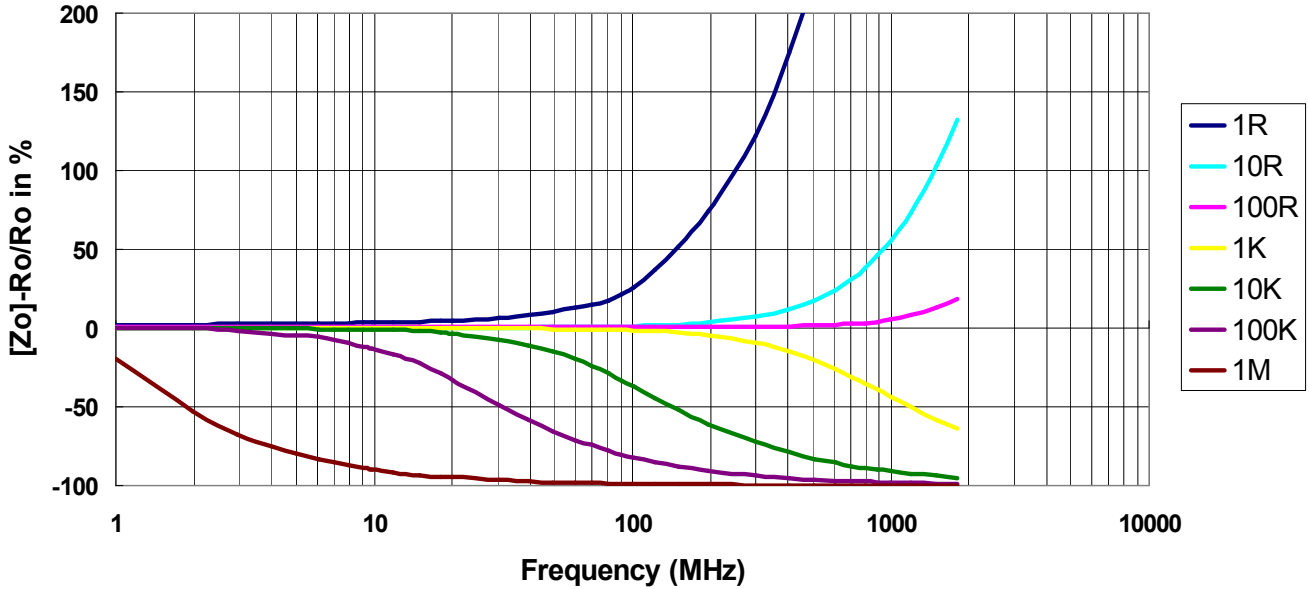

Frequency vs. Phase Angle CSR Series(CSR0207)

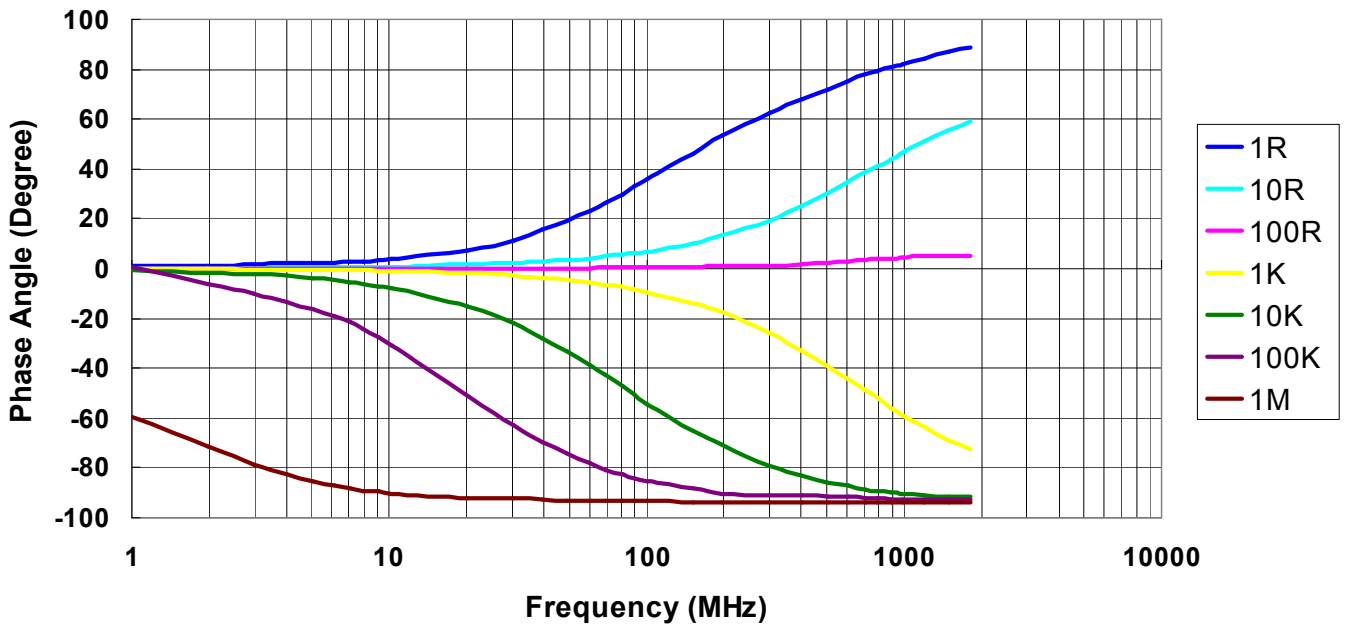

■ Lightning Surge

Resistors are tested in accordance with IEC 60 115-1 using both 1.2/50us and 10/700us pulse shapes. The limit of acceptance is a shift in resistance of less than 0.5% from the initial value.

1.2/50μs Lightning Surge

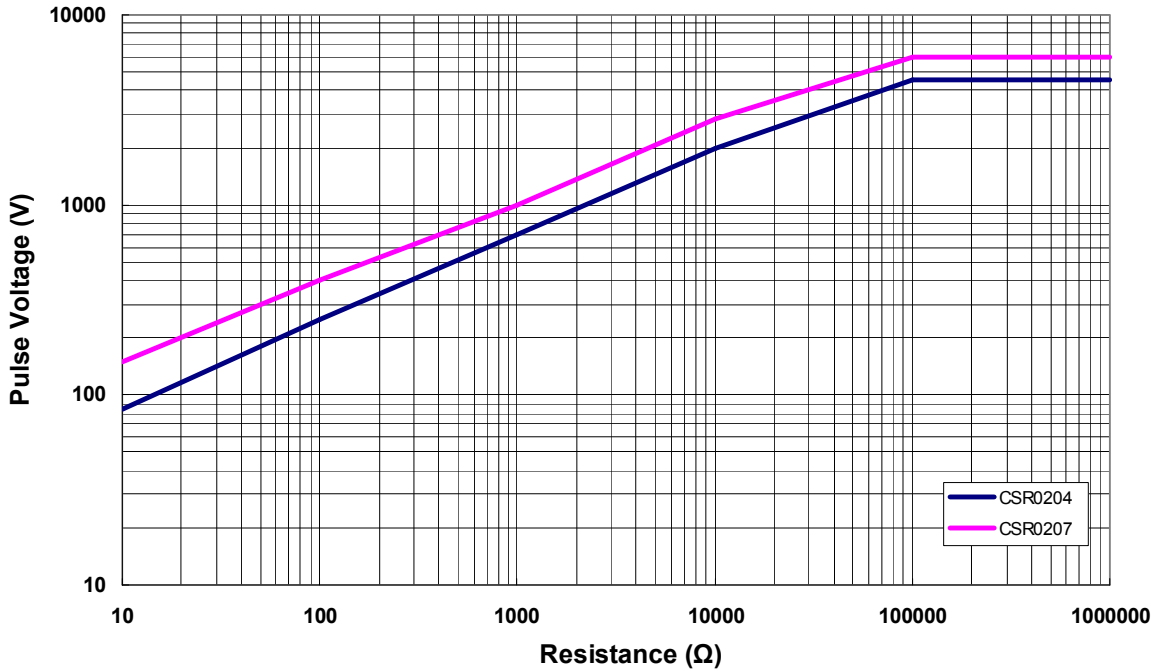

10/700μs Lightning Surge

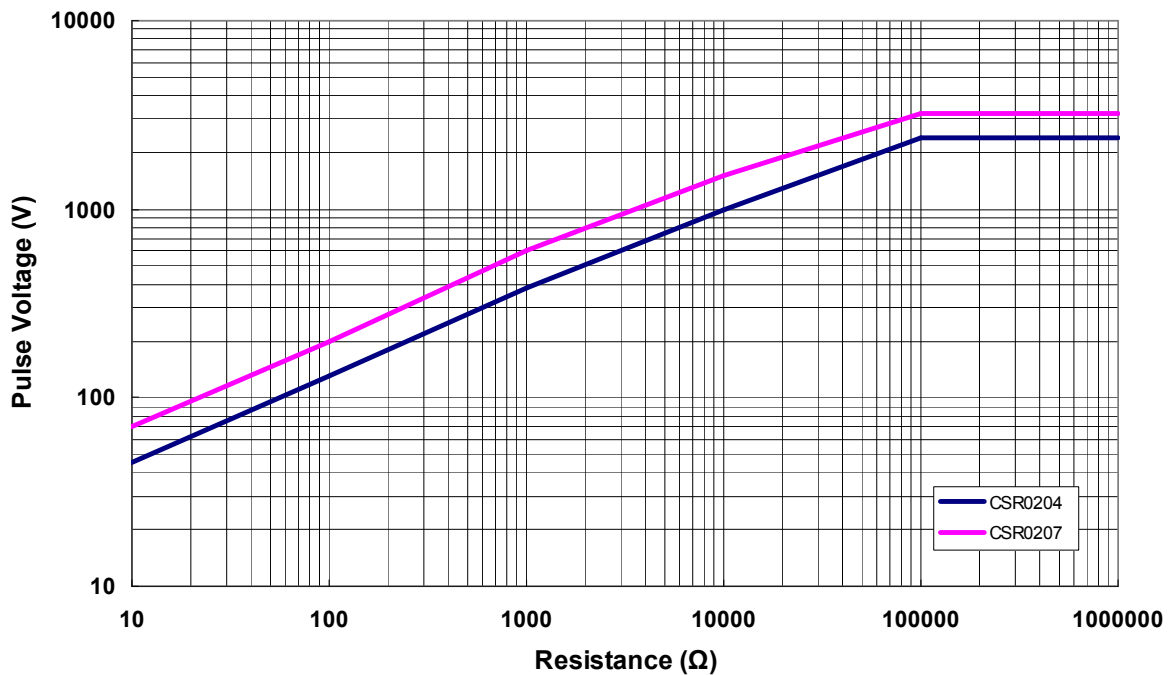

Metal Film Precision Resistor

■ Marking & Resistance Tolerance

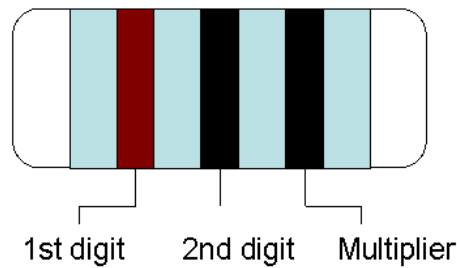

±5%	E-24	1.0	1.1	1.2	1.3	1.5	1.6	1.8	2.0	2.2	2.4	2.7	3.0	3.3	3.6	3.9	4.3	4.7	5.1	5.6	6.2	6.8	7.5	8.2	9.1
-----	------	-----	-----	-----	-----	-----	-----	-----	-----	-----	-----	-----	-----	-----	-----	-----	-----	-----	-----	-----	-----	-----	-----	-----	-----

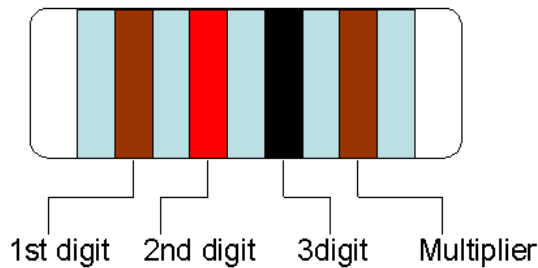

±1%	E-96	1.00	1.02	1.05	1.07	1.10	1.13	1.15	1.18	1.21	1.24	1.27	1.30	1.33	1.37	1.40	1.43	1.47	1.50	1.54	1.58	1.62	1.65	1.69	1.74
		1.78	1.82	1.87	1.91	1.96	2.00	2.05	2.10	2.15	2.21	2.26	2.32	2.37	2.43	2.49	2.55	2.61	2.67	2.74	2.80	2.87	2.94	3.01	3.09
		3.16	3.24	3.32	3.40	3.48	3.57	3.65	3.74	3.83	3.92	4.02	4.12	4.22	4.32	4.42	4.53	4.64	4.75	4.87	4.99	5.11	5.23	5.36	5.49
		5.62	5.76	5.90	6.04	6.19	6.34	6.49	6.65	6.81	6.98	7.15	7.32	7.50	7.68	7.87	8.06	8.25	8.45	8.66	8.87	9.09	9.31	9.53	9.76
±0.5% ±0.25% ±0.1%	E-192	10.0	10.1	10.2	10.4	10.5	10.6	10.7	10.9	11.0	11.1	11.3	11.4	11.5	11.7	11.8	12.0	12.1	12.3	12.4	12.6	12.7	12.9	13.0	13.2
		13.3	13.5	13.7	13.8	14.0	14.2	14.3	14.5	14.7	14.9	15.0	15.2	15.4	15.6	15.8	16.0	16.2	16.4	16.5	16.7	16.9	17.2	17.4	17.6
		17.8	18.0	18.2	18.4	18.7	18.9	19.1	19.3	19.6	19.8	20.0	20.3	20.5	20.8	21.0	21.3	21.5	21.8	22.1	22.3	22.6	22.9	23.2	23.4
		23.7	24.0	24.3	24.6	24.9	25.2	25.5	25.8	26.1	26.4	26.7	27.1	27.4	27.7	28.0	28.4	28.7	29.1	29.4	29.8	30.1	30.5	30.9	31.2
		31.6	32.0	32.4	32.8	33.2	33.6	34.0	34.4	34.8	35.2	35.7	36.1	36.5	37.0	37.4	37.9	38.3	38.8	39.2	39.7	40.2	40.7	41.2	41.7
		42.2	42.7	43.2	43.7	44.2	44.8	45.3	45.9	46.4	47.0	47.5	48.1	48.7	49.3	49.9	50.5	51.1	51.7	52.3	53.0	53.6	54.2	54.9	55.6
		56.2	56.9	57.6	58.3	59.0	59.7	60.4	61.2	61.9	62.6	63.4	64.2	64.9	65.7	66.5	67.3	68.1	69.0	69.8	70.6	71.5	72.3	73.2	74.1
		75.0	75.9	76.8	77.7	78.7	79.6	80.6	81.6	82.5	83.5	84.5	85.6	86.6	87.6	88.7	89.8	90.9	92.0	93.1	94.2	95.3	96.5	97.6	98.8

Color	Digit	Multiplier
Silver	-	10 ⁻²
Gold	-	10 ⁻¹
Black	0	10 ⁰
Brown	1	10 ¹
Red	2	10 ²
Orange	3	10 ³
Yellow	4	10 ⁴
Green	5	10 ⁵
Blue	6	10 ⁶
Violet	7	10 ⁷
Grey	8	10 ⁸
White	9	10 ⁹

※Resistance more than two significant figures(<1R) or more than three significant figures(>1R) will not provide color code.

REVISION HISTORY

REVISION	DATE	CHANGE NOTIFICATION	DESCRIPTION
Version B9	Jun 03, 2014	-	- Electrical Specifications updated - Environmental Characteristics updated
Version C	Feb 25, 2015	-	- Max overload voltage updated - Increase the color code Description
Version C1	Apr 30, 2015	-	- Electrical Specifications updated (CSR0102) - Dimension "K" updated
Version C2	Jul 07, 2015	-	- Increase CSR0102 Characteristic Curve
Version C3	Jul 15, 2016	-	- Modify Storage Temperature - Remove CSR0102 specification
Version C4	Jun 01, 2017	-	- Electrical Specifications updated

X-ON Electronics

Largest Supplier of Electrical and Electronic Components

Click to view similar products for [Thick Film Resistors - SMD category](#):

Click to view products by [Viking manufacturer](#):

Other Similar products are found below :

[CR-05FL7--150R](#) [CR-05FL7--698K](#) [CR-12FP4--324R](#) [CR-12JP4--680R](#) [M55342K06B10D0RS6](#) [M55342K06B14E0RS6](#)
[M55342K06B1E78RS3](#) [M55342K06B24E9RS6](#) [M55342K06B6E19RWL](#) [M55342K06B6E81RS3](#) [M55342M05B200DRWB](#)
[M55342M06B4K70MS3](#) [MC0603-511-JTW](#) [742C083750JTR](#) [MCR01MZPF1202](#) [MCR01MZPF1601](#) [MCR01MZPF1800](#)
[MCR01MZPF6201](#) [MCR01MZPF9102](#) [MCR01MZPJ113](#) [MCR01MZPJ121](#) [MCR01MZPJ125](#) [MCR01MZPJ751](#) [MCR03EZHZ103](#)
[MCR03EZPF2004](#) [MCR03EZPJ270](#) [MCR03EZPJ821](#) [MCR10EZPF1102](#) [MCR10EZPF2700](#) [MCR18EZPJ330](#) [RC1005F1152CS](#)
[RC1005F1182CS](#) [RC1005F1372CS](#) [RC1005F183CS](#) [RC1005F1911CS](#) [RC1005F1912CS](#) [RC1005F203CS](#) [RC1005F2052CS](#)
[RC1005F241CS](#) [RC1005F2431CS](#) [RC1005F3011CS](#) [RC1005F303CS](#) [RC1005F4321CS](#) [RC1005F4642CS](#) [RC1005F471CS](#)
[RC1005F4751CS](#) [RC1005F5621CS](#) [RC1005F6041CS](#) [RC1005J106CS](#) [RC1005J121CS](#)