

Data Sheet

Customer:

Product: Supercapacitor — SC Series

Rated Voltage.: 2.7V / 3.0V / 3.8V / 5.5V

Issued Date: 27-Jul-22

Edition: REV.A



VIKING TECH CORPORATION

光韻科技股份有限公司

No.70, Kuanfu N. Rad.,

Hsin Chu Industrial Park,

Hukou Hsiang, Hsin Chu Hsien,

303, Taiwan

TEL:886-3-5972931

FAX:886-3-5972935•886-3-5973494

E-mail:sales@viking.com.tw

VIKING TECH CORPORATION KAOHSIUNG BRANCH

光韻科技股份有限公司高雄分公司

No.248-3, Sin-Sheng Rd., Cian-Jhen Dist., Kaohsiung,

806, Taiwan

TEL:886-7-8217999

FAX:886-7-8228229

E-mail:sales@viking.com.tw

WUXI TMTEC CO., LTD.

無錫泰銘電子有限公司

No.22 Xixia Road, Machinery & Industry Park,

National Hi-Tech Industrial Development Zone

of Wuxi, Wuxi, Jiangsu Province, China

Zip Code:214028

TEL:86-510-85203339

FAX:86-510-85203667•86-510-85203977

E-mail:china@viking.com.tw

Produced by (QC)	Checked (QC)	Approved by (QC)	Prepared by (Sales)	Accepted by (Customer)
27-Jul-22	27-Jul-22	27-Jul-22		
<i>Mandy Chen</i>	<i>Ben Chang</i>	<i>Ben Chang</i>		

Supercapacitor

■ Features

For Coin Type

- Green, meet RoHS requirements.
- Long charge-discharge cycle life.
- Low leakage current, suitable for keeping the clock chip data.
- Wide operating temperature range.



For Lithium Ion Type

- Lithium ion capacitor is a new type of energy storage element which combines the high power density of double layer capacitor and the high energy density of lithium ion battery, the application prospect is broad.
- Wide operating temperature range -40°C rechargeable, 85°C available for discharge.
- Green, meet RoHS requirements



For Standard Cylindrical Type / Low ESR Cylindrical Type / High Voltage Cylindrical Type / High Temperature Cylindrical Type / Standard Combined Type / High Voltage Combined Type / High Temperature Combined Type

- Low internal resistance and high power density
- Self-discharge rate is small, 72 hours self-discharge<20%
- Excellent cycle life, the coulomb efficiency is more than 95%
- Wide operating temperature ranges
- Green, meet RoHS requirements



■ Applications

For Coin Type

- Working current from uA~10mA, working time from seconds to months.
- Can be used for Hand-cranked flashlight, Electric meter, The clock to keep, Electrical home appliances control, Toys, etc.

For Lithium Ion Type

- Intelligent Instrument, Automobile Data Recorder, Illumination Lamp
- ETC, Fiscal Cash Register, Digital Camera, Power Tools
- Wireless Energy Saving Mouse, Wireless Handwriting Board, SSD Solid State Drive

For Standard Cylindrical Type / Low ESR Cylindrical Type / High Voltage Cylindrical Type / High Temperature Cylindrical Type / Standard Combined Type / High Voltage Combined Type / High Temperature Combined Type

- Intelligent instrument, automobile data recorder, illumination lamp
- Fiscal cash register, digital camera, power tools
- Wireless energy saving mouse, wireless handwriting board, SSD solid state drive

■ Product Identification

SC	2V7		105	M		-1
Product Type	Rated Voltage	Shape Type	Capacitance	Capacitance Tolerance	Series Code	Special
	2V7: 2.7V 3V0: 3.0V 3V8: 3.8V 5V5: 5.5V	C: Coin & C Type H: Coin & H Type V: Coin & V Type M: Lithium Ion Type L: Cylindrical & Radial Type S: Cylindrical & Snap In Type F: Cylindrical & Four tab Solderable Type Z: Combined Type	104: 0.1F 105: 1F 106: 10F 308: 3000F	M: ±20% Z: +80/-20% 9 :+30/-10%	: Standard LR: Low ESR V: High Voltage H: High Temperature	

Supercapacitor

■ Coin Type Supercapacitor

Specifications

Performance	Performance Characteristics	Notes
Capacitance Range	0.1~1.5F	I=2mA
Capacitance Tolerance	+80/-20%	@25°C
Rated Operating Voltage	5.5V	DC
Operating Temperature Range	-25°C ~+70°C	

Specifications Value of Product : Coin & C Type

Part No.	Nominal Voltage DC(V)	Capacitance (F)	Max ESR 1kHz@25°C (Ω)	Leakage Current (25°C 24h, mA)	mWh Max. stored energy
SC5V5C104Z	5.5	0.10	60	0.005	0.42
SC5V5C224Z	5.5	0.22	50	0.005	0.92
SC5V5C334Z	5.5	0.33	40	0.007	1.39
SC5V5C474Z	5.5	0.47	40	0.010	1.97
SC5V5C105Z	5.5	1.00	15	0.012	4.20
SC5V5C155Z	5.5	1.50	10	0.012	6.30

Specifications Value of Product : Coin & H Type

Part No.	Nominal Voltage DC(V)	Capacitance (F)	Max ESR 1kHz@25°C (Ω)	Leakage Current (25°C 24h, mA)	mWh Max. stored energy
SC5V5H104Z	5.5	0.10	50	0.005	0.42
SC5V5H224Z	5.5	0.22	40	0.005	0.92
SC5V5H334Z	5.5	0.33	40	0.008	1.39
SC5V5H474Z	5.5	0.47	40	0.010	1.97
SC5V5H105Z	5.5	1.00	15	0.012	4.20
SC5V5H155Z	5.5	1.50	12	0.015	6.30

Specifications Value of Product : Coin & V Type

Part No.	Nominal Voltage DC(V)	Capacitance (F)	Max ESR 1kHz@25°C (Ω)	Leakage Current (25°C 24h, mA)	mWh Max. stored energy
SC5V5V104Z	5.5	0.10	50	0.005	0.42
SC5V5V224Z	5.5	0.22	50	0.005	0.92
SC5V5V334Z	5.5	0.33	40	0.008	1.39
SC5V5V474Z	5.5	0.47	40	0.010	1.97
SC5V5V105Z	5.5	1.00	15	0.012	4.20
SC5V5V155Z	5.5	1.50	12	0.015	6.30

Supercapacitor

Dimensions

Part No.	Figure	D (mm)	P (mm)	C (mm)	h (mm)	H (mm)	B (mm)
SC5V5C104Z	1	13.2±0.5	5.0±0.5	0.9±0.15	7.0±0.5	13.0±0.5	0.5±0.10
SC5V5C224Z	1	13.2±0.5	5.0±0.5	0.9±0.15	7.0±0.5	13.0±0.5	0.5±0.10
SC5V5C334Z	1	13.2±0.5	5.0±0.5	0.9±0.15	7.0±0.5	13.0±0.5	0.5±0.10
SC5V5C474Z	1	13.2±0.5	5.0±0.5	0.9±0.15	7.0±0.5	13.0±0.5	0.5±0.10
SC5V5C105Z	2	21.0±0.5	5.0±0.5	0.9±0.15	7.5±0.5	12.5±1.0	0.5±0.10
SC5V5C155Z	2	21.0±0.5	5.0±0.5	0.9±0.15	7.5±0.5	12.5±1.0	0.5±0.10
SC5V5H104Z	3	12.0±0.5	10.0±0.5	0.8±0.10	4.8±0.5	10.0±1.0	0.25±0.05
SC5V5H224Z	3	12.0±0.5	10.0±0.5	0.8±0.10	4.8±0.5	10.0±1.0	0.25±0.05
SC5V5H334Z	3	12.0±0.5	10.0±0.5	0.8±0.10	4.8±0.5	10.0±1.0	0.25±0.05
SC5V5H474Z	3	12.0±0.5	10.0±0.5	0.8±0.10	4.8±0.5	10.0±1.0	0.25±0.05
SC5V5H105Z	4	19.2±0.5	19.5±0.5	1.0±0.10	4.8±0.5	9.5±1.0	0.25±0.05
SC5V5H155Z	4	19.2±0.5	19.5±0.5	1.0±0.10	4.8±0.5	9.5±1.0	0.25±0.05
SC5V5V104Z	5	12.0±0.5	5.0±0.5	0.8±0.10	4.8±0.5	16.2±0.5	0.25±0.05
SC5V5V224Z	5	12.0±0.5	5.0±0.5	0.8±0.10	4.8±0.5	16.2±0.5	0.25±0.05
SC5V5V334Z	5	12.0±0.5	5.0±0.5	0.8±0.10	4.8±0.5	16.2±0.5	0.25±0.05
SC5V5V474Z	5	12.0±0.5	5.0±0.5	0.8±0.10	4.8±0.5	16.2±0.5	0.25±0.05
SC5V5V105Z	6	19.2±0.5	5.0±0.5	1.0±0.10	4.8±0.5	24.0±0.5	0.25±0.05
SC5V5V155Z	6	19.2±0.5	5.0±0.5	1.0±0.10	4.8±0.5	24.0±0.5	0.25±0.05

Outline and Dimensions

Fig.1

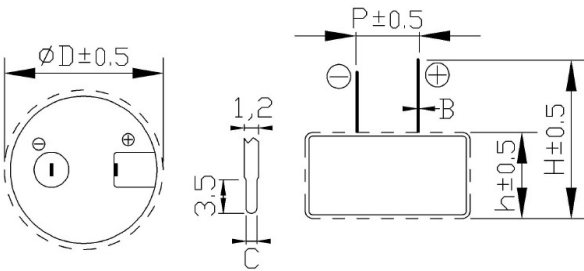

Fig.2

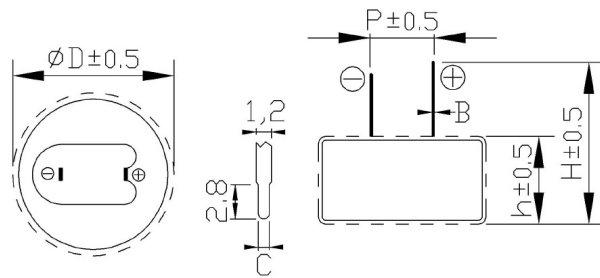

Fig.3

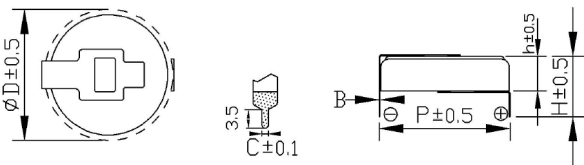

Fig.4

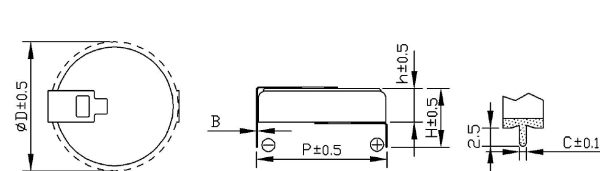

Fig.5

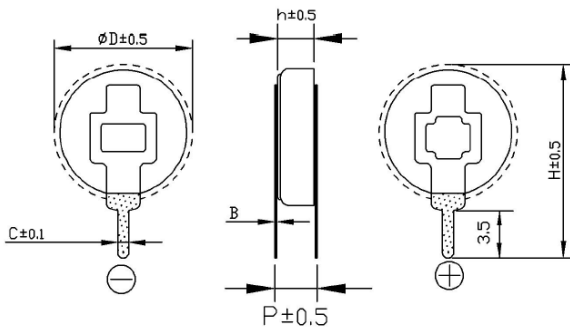
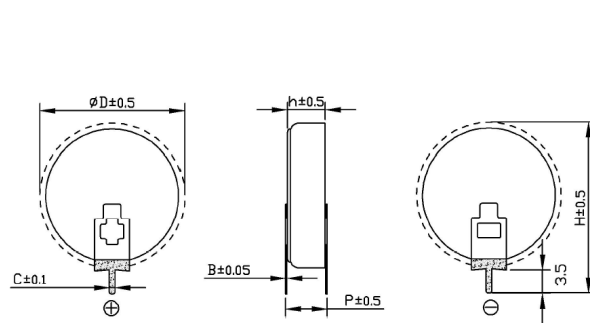

Fig.6



■The actual size and tolerance shall be subject to the parameter table.

Supercapacitor

Packing Specification

Part No.	Plastic Tray (EA)
SC5V5C104Z	168
SC5V5C224Z	168
SC5V5C334Z	168
SC5V5C474Z	168
SC5V5C105Z	70
SC5V5C155Z	70
SC5V5H104Z	168
SC5V5H224Z	168
SC5V5H334Z	168
SC5V5H474Z	168
SC5V5H105Z	80
SC5V5H155Z	80
SC5V5V104Z	196
SC5V5V224Z	196
SC5V5V334Z	196
SC5V5V474Z	196
SC5V5V105Z	70
SC5V5V155Z	70

Environmental Characteristics

Item	Requirement		Test Condition	
Characteristics in different temperature	Step 2	△C	Less than or equal to 30% of the initial value	Step 1: +25°C ±2°C Step 2: -25°C ±2°C Step 3: +70°C ±2°C Step 4: +25°C ±2°C
		ESR	Less than or equal to 400% of the initial value	
	Step 3	△C	Less than or equal to 30% of the initial value	
		ESR	Less than or equal to the initial value	
		LC	Less than or equal to 4 times the initial value	
	Step 4	△C	Satisfies the range of 20% of the initial rating	
		ESR	Satisfies the initial value	
		LC	Satisfies the initial value	
Endurance	△C	Less than or equal to 30% of the initial value	Applied voltage: 5.5V Temperature: +70°C ±2°C Time: 1000h	
	ESR	Less than or equal to 4 times the initial value		
	LC	Less than or equal to the initial measurement		
	Appearance	No leakage or mechanical damage		
Cycle life	△C	Less than or equal to 30% of the initial value	Capacitors cycles 500000 times between rated voltage and half rated voltage under constant current at 25°C	
	ESR	Less than or equal to 4 times the initial value		
Humidity Characteristics	△C	Satisfies the range of 30% of the initial rating	Temperature: +40°C ±2°C Relative humidity: 90~95%RH Test time: 240h	
	ESR	Less than or equal to 2 times the initial value		
	LC	Less than or equal to 4 times the initial value		
	Appearance	No leakage or mechanical damage		
Temperature cycle	C	Satisfies the initial value	Temperature cycle: -25°C ±2°C →normal temperature →+70°C ±2°C →normal temperature Cycles: 5	
	ESR	Satisfies the initial value		
	LC	Satisfies the initial value		
	Appearance	No mechanical damage or leakage		
Shelf life	C	Satisfies the range of 20% of the initial rating	Applied voltage: 0V Temperature: +70°C ±2°C Time: 1000h	
	ESR	Less than or equal to 3 times the initial value		
	LC	Less than or equal to the initial measurement		
	Appearance	No leakage or mechanical damage		
Self discharge characteristics (voltage holding characteristics)	Voltage between positive and negative poles ≥4.4V		Charging process: normal temperature, no load, rated voltage charge 8h Placement process: temperature less than or equal to 25 °C, relative humidity less than 60% RH, open 24 h	
Lead strength	No damage to the outlet			
Solder ability	More than 3/4 of the terminal surface is covered by a tin layer			

Storage Temperature: -30~50°C; Relative Humidity:<60%RH, Max. Humidity<85%RH

Supercapacitor

■ Lithium Ion Type Supercapacitor

Specifications

Performance	Performance Characteristics	Notes
Capacitance Range	20~120F	45mA
Capacitance Tolerance	+80/-20%	@25°C
Operating Voltage Range	3.8V	DC
Mix Voltage	2.5V	
Operating Temperature Range	-20°C ~+65°C	

Specifications Value of Standard Product

Part No.	Rated Voltage DC (V)	Capacitance		MAX ESR AC,1KHz,3.8V (mΩ)	Charge @4.0 V		Discharge	
		(F)	25°C (mA)		Standard (mA)	Rapid (mA)	Maximum Continuous Discharge Current (mA)	Pulse (1 sec) (A)
SC3V8M206Z	3.8	20	7.5	500	75	200	100	0.5
SC3V8M406Z	3.8	40	15	200	150	300	200	1.0
SC3V8M706Z	3.8	70	25	170	250	500	250	3.0
SC3V8M806Z	3.8	80	28	150	280	560	300	3.0
SC3V8M127Z	3.8	120	45	100	450	1000	500	5.0

Dimensions

Part No.	D (mm)	L (mm)	P (mm)	d (mm)
SC3V8M206Z	8±0.5	13±1.5	3.5±0.5	0.6±0.1
SC3V8M406Z	8±0.5	20±1.5	5.0±3.5	0.6±0.1
SC3V8M706Z	13±0.5	13±1.0	5.0±0.5	0.6±0.1
SC3V8M806Z	10±0.5	20±1.0	5.0±0.5	0.8±0.1
SC3V8M127Z	10±0.5	20±1.0	5.0±0.5	0.8±0.1

Outline and Dimensions

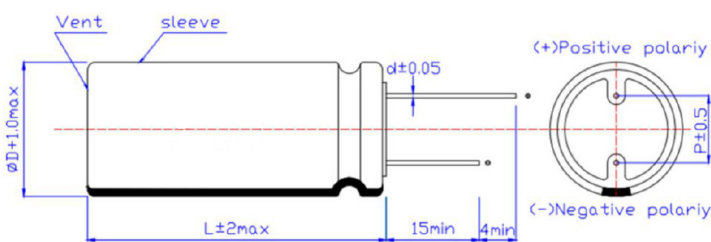

■ The actual size and tolerance shall be subject to the parameter table.

Packing Specification

Part No.	Plastic Tray (EA)
SC3V8M206Z	60
SC3V8M406Z	60
SC3V8M706Z	60
SC3V8M806Z	60
SC3V8M127Z	60

Supercapacitor

■ Environmental Characteristics

Item	Requirement		Test Condition
Optimum storage condition	-10 ~ 50°C, ≤65%RH		
Characteristics in different temperature	Step 2	△C	20F: Less than or equal to 50% of the initial value 40F/70F/80F/120F: Less than or equal to 30% of the initial value
		ESR	Less than or equal to 1000% of the specified value
	Step 3	△C	Less than or equal to 30% of the initial value
		ESR	Less than or equal to 200% of the specified value
	Step 4	△C	Satisfies the range of 20% of the initial rating
		ESR	Satisfies the initial value
Endurance	△C	Satisfies the range of 30% of the initial value	Temperature: +65°C±2°C (20F); +55±2°C (40F/70F/80F/120F) Time: 1000h
	ESR	Less than or equal to 400% of the specified value	
	Appearance	No leakage or mechanical damage	
Cycle life	△C	Satisfies the range of 30% of the initial value	3.1V ~ 3.7V 20F: 75mA 40F: 150mA 70F: 250mA 80F: 280mA 120F: 450mA Temperature: +25°C±2°C Cycles: 100000
	ESR	Less than or equal to 400% of the specified value	
Forced Discharge	No fire No explosion		Recharge the Asymmetry Super Capacitor by standard charge, discharge at a current of 75mA(20F)/200mA(40F)/250mA(70F)/300mA(80F)/500mA(120F) for 2.5h.
Vibration Test	No leakage No fire		After standard charging, fixed the cell to vibration table and subjected to vibration cycling that the frequency is to be varied at the rate of 1 Hz per minute between 10Hz ~ 55Hz, the excursion of the vibration is 1.6mm. The cell shall be vibrated for 30 minutes per axis of XYZ axes.
Drop	No leakage No fire No burst or explosion		After standard charging. Drop the product from the height of 1.0m to a hardwood of 20mm thick, and fall down the X,Y,Z respectively for one time.
Impact	No fire No explosion Allows for deformation		Place the product on the impact table, with a diameter of 15.8mm. the 10-kilogram weight of the weight is freely falling from 1m, and the impact has been fixed in the fixture.
Low Temperature	No fire No explosion 20F: The discharge capacity is more than 50% of the initial capacity. 40F/70F/80F/120F: The discharge capacity is more than 70% of the initial capacity.		Recharge the Asymmetry Super Capacitor by standard charge, Place the cell in low temperature -40°C(20F) / -20°C(40F/70F/80F/120F), 4h. environment, Then 75mA(20F)/200mA(40F)/250mA(70F)/300mA(80F)/500mA(120F) is then discharged to 3.0V

Supercapacitor

■ Standard Cylindrical Type Supercapacitor

Specifications

Performance	Performance Characteristics	Notes
Capacitance Range	0.5~400F	$I=8 \cdot CU_R$ (mA)
Capacitance Tolerance	±20%	@25°C
Rated Voltage	2.7V	DC
Operating Temperature Range	-40°C ~+70°C	

Specifications Value of Standard Product : Cylindrical & Radial Type

Part No.	Rated Voltage (V)	Rated Capacitance (F)	Max. ESR DC 25°C (mΩ)	Nominal Current (25°C, A)	Maximum Peak Current (25°C<1s, A)	Leakage Current (25°C 72h, mA)
SC2V7L504M	2.7	0.5	500	0.13	0.54	0.008
SC2V7L105M	2.7	1	350	0.25	1.00	0.008
SC2V7L105M-1	2.7	1	350	0.25	1.00	0.008
SC2V7L205M	2.7	2	180	0.50	1.99	0.012
SC2V7L305M	2.7	3	120	0.76	2.98	0.013
SC2V7L335M	2.7	3.3	120	0.83	3.19	0.013
SC2V7L505M	2.7	5	80	1.25	4.82	0.016
SC2V7L505M-1	2.7	5	75	1.26	4.91	0.016
SC2V7L605M	2.7	6	75	1.49	5.59	0.024
SC2V7L705M	2.7	7	70	1.72	6.34	0.028
SC2V7L106M	2.7	10	65	2.39	8.18	0.030
SC2V7L156M	2.7	15	55	3.48	11.10	0.050
SC2V7L206M	2.7	20	45	4.58	14.21	0.060
SC2V7L256M	2.7	25	30	5.87	19.29	0.070
SC2V7L306M	2.7	30	30	6.86	21.32	0.078
SC2V7L506M	2.7	50	25	10.80	30.00	0.100
SC2V7L606M	2.7	60	25	12.46	32.40	0.120

■Nominal Current: Is the current taking 5 sec. to discharge from U_R to $1/2U_R$.

■Maximum Peak Current: Is the current taking 1 sec. to discharge from U_R to $1/2U_R$

Specifications Value of Product : Cylindrical & Snap In Type

Part No.	Rated Voltage (V)	Rated Capacitance (F)	Max. ESR DC 25°C (mΩ)	Maximum Continuous Current ($\Delta T=15^\circ\text{C}$, A)	Maximum Peak Current (25°C<1s, A)	Leakage Current (25°C 72h, mA)
SC2V7S127M	2.7	120	18	6.5	51.27	1.000
SC2V7S227M	2.7	220	15	8.8	85.00	1.500
SC2V7S357M	2.7	350	9	15.0	114.00	1.500
SC2V7S407M	2.7	400	9	9.4	117.00	2.200

■Maximum Peak Current: Is the current taking 1 sec. to discharge from U_R to $1/2U_R$

Supercapacitor

Dimensions

Part No.	Figure	D (mm)	L (mm)	P (mm)	d (mm)	L1 (mm)	F (mm)
SC2V7L504M	1	6.3±1.0	12.5±1.0	2.5±0.5	0.5±0.05	-	-
SC2V7L105M	1	6.3±1.0	12.5±1.0	2.5±0.5	0.5±0.05	-	-
SC2V7L105M-1	1	8.0±1.0	13.0±1.0	3.5±0.5	0.6±0.05	-	-
SC2V7L205M	1	8.0±1.0	16.0±1.0	3.5±0.5	0.6±0.05	-	-
SC2V7L305M	1	8.0±1.0	20.0±1.0	3.5±0.5	0.6±0.05	-	-
SC2V7L335M	1	8.0±1.0	20±1.0	3.5±0.5	0.6±0.05	-	-
SC2V7L505M	1	8.0±1.0	24.0±1.0	3.5±0.5	0.6±0.05	-	-
SC2V7L505M-1	1	10.0±1.0	20.0±1.0	5.0±0.5	0.6±0.05	-	-
SC2V7L605M	1	10.0±1.0	20.0±1.0	5.0±0.5	0.6±0.05	-	-
SC2V7L705M	1	10.0±1.0	20.0±1.0	5.0±0.5	0.6±0.05	-	-
SC2V7L106M	1	10.0±1.0	25.0±1.0	5.0±0.5	0.6±0.05	-	-
SC2V7L156M	1	12.5±1.0	25.0±1.0	5.0±0.5	0.6±0.05	-	-
SC2V7L206M	1	12.5±1.5	25.0±1.5	5.0±0.5	0.6±0.05	-	-
SC2V7L256M	1	16.0±0.5	25.0±2.0	7.5±0.5	0.8±0.05	-	-
SC2V7L306M	1	16.0±0.5	30.0±2.0	7.5±0.5	0.8±0.05	-	-
SC2V7L506M	1	18.0±0.5	42.0±2.0	7.5±0.5	0.8±0.05	-	-
SC2V7L606M	1	18.0±0.5	42.0±2.0	7.5±0.5	0.8±0.05	-	-
SC2V7S127M	2	22.0±1.0	46.0±1.5	-	-	7.0±1.0	10.0±0.5
SC2V7S227M	2	30.6±1.0	50.0±1.5	-	-	6.5±1.0	10.0±0.5
SC2V7S357M	2	35.0±1.0	62.0±2.0	-	-	7.0±1.0	10.0±0.5
SC2V7S407M	2	35.0±1.0	62.0±2.0	-	-	7.0±1.0	10.0±0.5

Outline and Dimensions

Fig.1

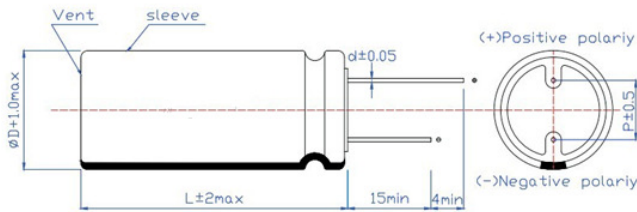
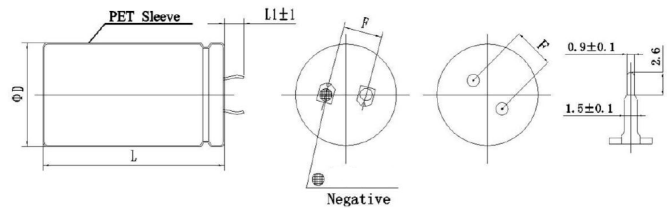

Fig.2



■ The actual size and tolerance shall be subject to the parameter table.

Packing Specification

Part No.	Plastic (EA)		
	Bag	Tray	Others
SC2V7L504M	2000	-	-
SC2V7L105M	2000	-	-
SC2V7L105M-1	1500	-	-
SC2V7L205M	1000	-	-
SC2V7L305M	1000	-	-
SC2V7L335M	1000	-	-
SC2V7L505M	1000	-	-
SC2V7L505M-1	800	-	-
SC2V7L605M	800	-	-
SC2V7L705M	800	-	-
SC2V7L106M	600	-	-
SC2V7L156M	400	-	-
SC2V7L206M	400	-	-
SC2V7L256M	250	-	-
SC2V7L306M	200	-	-
SC2V7L506M	-	32	-
SC2V7L606M	-	32	-
SC2V7S127M	-	-	-
SC2V7S227M	-	-	-
SC2V7S357M	-	-	Bulk
SC2V7S407M	-	-	Bulk

Supercapacitor

■ Environmental Characteristics

Item	Requirement		Test Condition	
Characteristics in different temperature	Step 2	△C	Less than or equal to 30% of the initial value	Step 1: +25°C ±2°C Step 2: -40°C ±2°C Step 3: +70°C ±2°C Step 4: +25°C ±2°C
		ESR	Less than or equal to 400% of the initial value	
	Step 3	△C	Less than or equal to 30% of the initial value	
		ESR	Less than or equal to the initial value	
		LC	Less than or equal to 4 times the initial value	
	Step 4	△C	Satisfies the range of 20% of the initial rating	
		ESR	Satisfies the initial value	
LC		Satisfies the initial value		
Endurance	△C	Less than or equal to 30% of the initial value	Applied voltage: 2.7V Temperature: +70°C ±2°C Time: 1000h	
	ESR	Less than or equal to 4 times the initial value		
	LC	Less than or equal to the initial measurement		
	Appearance	No leakage or mechanical damage		
Cycle life	△C	Less than or equal to 30% of the initial value	Applied voltage: 2.7V Temperature: +25°C ±2°C Cycles: 500000	
	ESR	Less than or equal to 4 times the initial value		
Humidity Characteristics	△C	Satisfies the range of 30% of the initial rating	Temperature: +40°C ±2°C Relative humidity: 90~95%RH Test time: 240h	
	ESR	Less than or equal to 2 times the initial value		
	LC	Less than or equal to 4 times the initial value		
	Appearance	No leakage or mechanical damage		
Temperature cycle	C	Satisfies the initial value	Temperature cycle: -40°C ±2°C →normal temperature →+70°C ±2°C →normal temperature Cycles: 5	
	ESR	Satisfies the initial value		
	LC	Satisfies the initial value		
	Appearance	No mechanical damage or leakage		
Shelf life	C	Satisfies the range of 20% of the initial rating	Applied voltage: 0V Temperature: +70°C ±2°C Time: 1000h	
	ESR	Less than or equal to 3 times the initial value		
	LC	Less than or equal to the initial measurement		
	Appearance	No leakage or mechanical damage		
Self discharge characteristics (voltage holding characteristics)	Voltage between positive and negative poles ≥2.3V SC2V7S227M: Voltage between positive and negative poles ≥2.1V		Charging process: normal temperature, no load, rated voltage charge 24h Placement process: temperature less than or equal to 25 °C, relative humidity less than 60% RH, open 24 h	
Lead strength	No damage to the outlet			
Solder ability	More than 3/4 of the terminal surface is covered by a tin layer			

■ Storage Temperature: -30~50°C; Relative Humidity: <60%RH, Max. Humidity <85%RH

Supercapacitor

■ Low ESR Cylindrical Type Supercapacitor

Specifications

Performance	Performance Characteristics	Notes
Capacitance Range	0.5~400F	$I=8^*CU_R(mA)$
Capacitance Tolerance	±20%	@25°C
Rated Voltage	2.7V	DC
Operating Temperature Range	-40°C ~+70°C	

Specifications Value of Product : Cylindrical & Radial Type

Part No.	Rated Voltage (V)	Capacitance (F)	Max. ESR DC 25°C (mΩ)	Nominal Current (25°C, A)	Maximum Peak Current (25°C<1s, A)	Leakage Current (25°C 72h, mA)
SC2V7L504MLR	2.7	0.5	280	0.13	0.59	0.013
SC2V7L105MLR	2.7	1	240	0.26	1.09	0.016
SC2V7L105MLR-1	2.7	1	200	0.26	1.13	0.016
SC2V7L205MLR	2.7	2	140	0.51	2.11	0.018
SC2V7L335MLR	2.7	3.3	80	0.85	3.52	0.021
SC2V7L505MLR	2.7	5	60	1.27	5.19	0.030
SC2V7L505MLR-1	2.7	5	60	1.27	5.19	0.030
SC2V7L605MLR	2.7	6	55	1.52	6.09	0.036
SC2V7L705MLR	2.7	7	50	1.77	7.00	0.042
SC2V7L106MLR	2.7	10	45	2.48	9.31	0.050

■Nominal Current: Is the current taking 5 sec. to discharge from U_R to $1/2U_R$.

■Maximum Peak Current: Is the current taking 1 sec. to discharge from U_R to $1/2U_R$

Specifications Value of Product : Cylindrical & Four tab Solderable Type

Part No.	Rated Voltage (V)	Capacitance (F)	Max. ESR DC 25°C (mΩ)	Nominal Current (25°C, A)	Maximum Peak Current (25°C<1s, A)	Leakage Current (25°C 72h, mA)
SC2V7F407MLR	2.7	400	0.9	100.75	397.06	1.3

■Nominal Current: Is the current taking 5 sec. to discharge from U_R to $1/2U_R$.

■Maximum Peak Current: Is the current taking 1 sec. to discharge from U_R to $1/2U_R$

Dimensions

Part No.	Figure	D (mm)	L (mm)	P (mm)	d (mm)
SC2V7L504MLR	1	6.3±1.0	12.5±1.0	2.5±0.5	0.5±0.05
SC2V7L105MLR	1	6.3±1.0	12.5±1.0	2.5±0.5	0.5±0.05
SC2V7L105MLR-1	1	8±1.0	13±1.0	3.5±0.5	0.6±0.05
SC2V7L205MLR	1	8±1.0	20±1.0	3.5±0.5	0.6±0.05
SC2V7L335MLR	1	8±1.0	20±1.0	3.5±0.5	0.6±0.05
SC2V7L505MLR	1	8±1.0	24±1.0	3.5±0.5	0.6±0.05
SC2V7L505MLR-1	1	10±1.0	20±1.0	5.0±0.5	0.6±0.05
SC2V7L605MLR	1	10±1.0	20±1.0	5.0±0.5	0.6±0.05
SC2V7L705MLR	1	10±1.0	20±1.0	5.0±0.5	0.6±0.05
SC2V7L106MLR	1	10±1.0	25±1.0	5.0±0.5	0.6±0.05
SC2V7F407MLR	2	35±0.5	69±2.0	-	-

Supercapacitor

Outline and Dimensions

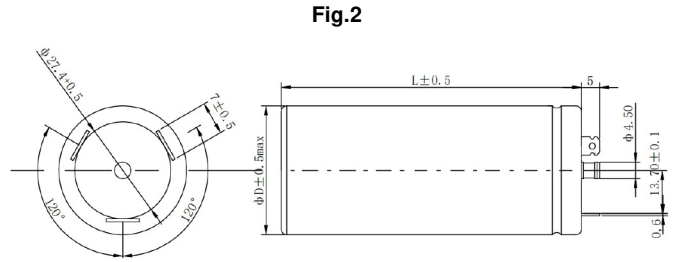
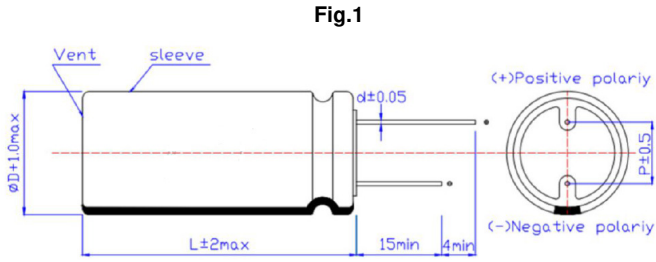

■The actual size and tolerance shall be subject to the parameter table.

Packing Specification

Part No.	Plastic (EA)	
	Bag	Others
SC2V7L504MLR	2000	-
SC2V7L105MLR	2000	-
SC2V7L105MLR-1	1500	-
SC2V7L205MLR	1000	-
SC2V7L335MLR	1000	-
SC2V7L505MLR	1000	-
SC2V7L505MLR-1	800	-
SC2V7L605MLR	800	-
SC2V7L705MLR	800	-
SC2V7L106MLR	600	-
SC2V7F407MLR	-	Bulk

Supercapacitor

Environmental Characteristics

Item	Requirement		Test Condition	
Characteristics in different temperature	Step 2	△C	Less than or equal to 30% of the initial value	Step 1: +25°C ±2°C Step 2: -40°C ±2°C Step 3: +70°C ±2°C Step 4: +25°C ±2°C
		ESR	Less than or equal to 400% of the initial value	
	Step 3	△C	Less than or equal to 30% of the initial value	
		ESR	Less than or equal to the initial value	
		LC	Less than or equal to 4 times the initial value	
	Step 4	△C	Satisfies the range of 20% of the initial rating	
		ESR	Satisfies the initial value	
LC		Satisfies the initial value		
Endurance	△C	Less than or equal to 30% of the initial value	Applied voltage: 2.7V Temperature: +70°C ±2°C Time: 1000h	
	ESR	Less than or equal to 4 times the initial value		
	LC	Less than or equal to the initial measurement		
	Appearance	No leakage or mechanical damage		
Cycle life	△C	Less than or equal to 30% of the initial value	Applied voltage: 2.7V Temperature: +25°C ±2°C Cycles: 500000	
	ESR	Less than or equal to 4 times the initial value		
Humidity Characteristics	△C	Satisfies the range of 30% of the initial rating	Temperature: +40°C ±2°C Relative humidity: 90~95%RH Test time: 240h	
	ESR	Less than or equal to 2 times the initial value		
	LC	Less than or equal to 4 times the initial value		
	Appearance	No leakage or mechanical damage		
Temperature cycle	C	Satisfies the initial value	Temperature cycle: -40°C ±2°C →normal temperature →+70°C ±2°C →normal temperature Cycles: 5	
	ESR	Satisfies the initial value		
	LC	Satisfies the initial value		
	Appearance	No mechanical damage or leakage		
Shelf life	C	Satisfies the range of 20% of the initial rating	Applied voltage: 0V Temperature: +70°C ±2°C Time: 1000h	
	ESR	Less than or equal to 3 times the initial value		
	LC	Less than or equal to the initial measurement		
	Appearance	No leakage or mechanical damage		
Self discharge characteristics (voltage holding characteristics)	Voltage between positive and negative poles ≥2.16V SC2V7F407MLR: Voltage between positive and negative poles ≥2.3V		Charging process: normal temperature, no load, rated voltage charge 24h Placement process: temperature less than or equal to 25 °C, relative humidity less than 60% RH, open 24 h	
Lead strength	No damage to the outlet			
Solder ability	More than 3/4 of the terminal surface is covered by a tin layer			

■Storage Temperature: -30~50°C; Relative Humidity:<60%RH, Max. Humidity<85%RH

Supercapacitor

High Voltage Cylindrical Type Supercapacitor

Specifications

Performance	Performance Characteristics	Notes
Capacitance Range	1~60F	$I=8 \cdot C U_R$ (mA)
Capacitance Tolerance	±20%	@25°C
Rated Voltage	3.0V	DC
Operating Temperature Range	-40°C ~+70°C	

Specifications Value of Product

Part No.	Rated Voltage (V)	Capacitance (F)	Max. ESR DC 25°C (mΩ)	Nominal Current (25°C, A)	Maximum Peak Current (25°C<1s, A)	Leakage Current (25°C 72h, mA)
SC3V0L105MV	3.0	1	300	0.28	1.15	0.008
SC3V0L335MV	3.0	3.3	120	0.92	3.55	0.013
SC3V0L505MV	3.0	5	90	1.38	5.17	0.016
SC3V0L505MV-1	3.0	5	80	1.39	5.36	0.016
SC3V0L106MV	3.0	10	70	2.63	8.82	0.032
SC3V0L156MV	3.0	15	50	3.91	12.86	0.052
SC3V0L256MV	3.0	25	30	6.52	21.43	0.075
SC3V0L306MV	3.0	30	30	7.63	23.68	0.075
SC3V0L0606MV	3.0	60	26	13.72	35.16	0.120

■Nominal Current: Is the current taking 5 sec. to discharge from U_R to $1/2U_R$.

■Maximum Peak Current: Is the current taking 1 sec. to discharge from U_R to $1/2U_R$

Dimensions

Part No.	D (mm)	L (mm)	P (mm)	d (mm)
SC3V0L105MV	8±1.0	13±1.0	3.5±0.5	0.6±0.05
SC3V0L335MV	8±1.0	20±1.0	3.5±0.5	0.6±0.05
SC3V0L505MV	8±1.0	24±1.0	3.5±0.5	0.6±0.05
SC3V0L505MV-1	10±1.0	20±1.0	5.0±0.5	0.6±0.05
SC3V0L106MV	10±1.0	25±1.0	5.0±0.5	0.6±0.05
SC3V0L156MV	12.5±1.0	25±1.0	5.0±0.5	0.6±0.05
SC3V0L256MV	16±2.0	25±2.0	7.5±0.5	0.8±0.05
SC3V0L306MV	16±2.0	30±2.0	7.5±0.5	0.8±0.05
SC3V0L0606MV	18±2.0	42±2.0	7.5±0.5	0.8±0.05

Outline and Dimensions

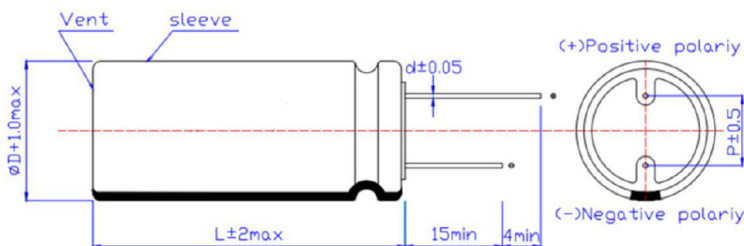

■The actual size and tolerance shall be subject to the parameter table.

Supercapacitor

Packing Specification

Part No.	Plastic (EA)	
	Bag	Tray
SC3V0L105MV	1500	
SC3V0L335MV	1000	
SC3V0L505MV	1000	
SC3V0L505MV-1	800	
SC3V0L106MV	600	
SC3V0L156MV	500	
SC3V0L256MV	250	
SC3V0L306MV	200	
SC3V0L0606MV	-	32

Environmental Characteristics

Item	Requirement			Test Condition
Characteristics in different temperature	Step 2	△C	Less than or equal to 30% of the initial value	Step 1: +25°C ±2°C Step 2: -40°C ±2°C Step 3: +70°C ±2°C Step 4: +25°C ±2°C
		ESR	Less than or equal to 400% of the initial value	
	Step 3	△C	Less than or equal to 30% of the initial value	
		ESR	Less than or equal to the initial value	
		LC	Less than or equal to 4 times the initial value	
	Step 4	△C	Satisfies the range of 20% of the initial rating	
		ESR	Satisfies the initial value	
		LC	Satisfies the initial value	
	Endurance	△C	Less than or equal to 30% of the initial value	
ESR		Less than or equal to 4 times the initial value		
LC		Less than or equal to the initial measurement		
Appearance		No leakage or mechanical damage		
Cycle life	△C	Less than or equal to 30% of the initial value	Applied voltage: 3.0V Temperature: +25°C ±2°C Cycles: 500000	
	ESR	Less than or equal to 4 times the initial value		
Humidity Characteristics	△C	Satisfies the range of 30% of the initial rating	Temperature: +40°C ±2°C Relative humidity: 90~95%RH Test time: 240h	
	ESR	Less than or equal to 2 times the initial value		
	LC	Less than or equal to 4 times the initial value		
	Appearance	No leakage or mechanical damage		
Temperature cycle	C	Satisfies the initial value	Temperature cycle: -40°C ±2°C →normal temperature →+70°C ±2°C →normal temperature Cycles: 5	
	ESR	Satisfies the initial value		
	LC	Satisfies the initial value		
	Appearance	No mechanical damage or leakage		
Shelf life	C	Satisfies the range of 20% of the initial rating	Applied voltage: 0V Temperature: +70°C ±2°C Time: 1000h	
	ESR	Less than or equal to 3 times the initial value		
	LC	Less than or equal to the initial measurement		
	Appearance	No leakage or mechanical damage		
Self discharge characteristics (voltage holding characteristics)	Voltage between positive and negative poles ≥2.55V			Charging process: normal temperature, no load, rated voltage charge 24h Placement process: temperature less than or equal to 25 °C, relative humidity less than 60% RH, open 24 h
Lead strength	No damage to the outlet			
Solder ability	More than 3/4 of the terminal surface is covered by a tin layer			

■Storage Temperature: -30~50°C; Relative Humidity:<60%RH, Max. Humidity<85%RH

Supercapacitor

High Temperature Cylindrical Type Supercapacitor

Specifications

Performance	Performance Characteristics	Notes
Capacitance Range	0.5~25F	$I=8 \cdot C U_R$ (mA)
Capacitance Tolerance	±20%	@25°C
Rated Voltage	2.7V	DC
Operating Temperature Range	-40°C ~+85°C	

Specifications Value of Product

Part No.	Rated Voltage (V)	Capacitance (F)	Max. ESR DC 25°C (mΩ)	Nominal Current (25°C, A)	Maximum Peak Current (25°C<1s, A)	Leakage Current (25°C 72h, mA)
SC2V7L504MH	2.7	0.5	600	0.13	0.52	0.010
SC2V7L105MH	2.7	1	400	0.25	0.96	0.012
SC2V7L205MH	2.7	2	300	0.48	1.69	0.013
SC2V7L205MH-1	2.7	2	260	0.49	1.78	0.013
SC2V7L305MH	2.7	3	120	0.76	2.98	0.015
SC2V7L335MH	2.7	3.3	120	0.83	3.19	0.015
SC2V7L505MH	2.7	5	80	1.25	4.82	0.016
SC2V7L605MH	2.7	6	80	1.48	5.47	0.024
SC2V7L705MH	2.7	7	75	1.71	6.20	0.028
SC2V7L106MH	2.7	10	70	2.37	7.94	0.030
SC2V7L256MH	2.7	25	40	5.63	16.88	0.070

■Note 1:Nominal Current: Is the current taking 5 sec. to discharge from U_R to $1/2U_R$.

■Note 2:Maximum Peak Current: Is the current taking 1 sec. to discharge from U_R to $1/2U_R$

Dimensions

Part No.	D (mm)	L (mm)	P (mm)	d (mm)
SC2V7L504MH	6.3±1.0	12.5±1.0	2.5±0.5	0.5±0.05
SC2V7L105MH	8.0±1.0	13.0±1.0	3.5±0.5	0.6±0.05
SC2V7L205MH	8.0±1.0	16.0±1.0	3.5±0.5	0.6±0.05
SC2V7L205MH-1	8.0±1.0	20.0±1.0	3.5±0.5	0.6±0.05
SC2V7L305MH	8.0±1.0	20.0±1.0	3.5±0.5	0.6±0.05
SC2V7L335MH	8.0±1.0	20.0±1.0	3.5±0.5	0.6±0.05
SC2V7L505MH	8.0±1.0	24.0±1.0	3.5±0.5	0.6±0.05
SC2V7L605MH	10.0±1.0	20.0±1.0	5.0±0.5	0.6±0.05
SC2V7L705MH	10.0±1.0	20.0±1.0	5.0±0.5	0.6±0.05
SC2V7L106MH	10.0±1.0	25.0±1.0	5.0±0.5	0.6±0.05
SC2V7L256MH	16.0±0.5	25.0±2.0	7.5±0.5	0.8±0.05

Outline and Dimensions

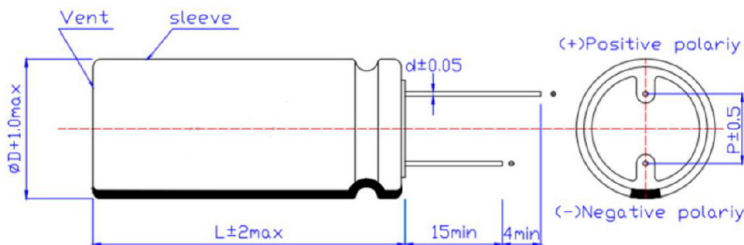

■The actual size and tolerance shall be subject to the parameter table.

Supercapacitor

Packing Specification

Part No.	Plastic (EA)
	Bag
SC2V7L504MH	2000
SC2V7L105MH	1500
SC2V7L205MH	1000
SC2V7L205MH-1	1000
SC2V7L305MH	1000
SC2V7L335MH	1000
SC2V7L505MH	1000
SC2V7L605MH	800
SC2V7L705MH	800
SC2V7L106MH	600
SC2V7L256MH	250

Environmental Characteristics

Item	Requirement		Test Condition	
Characteristics in different temperature	Step 2	△C	Less than or equal to 30% of the initial value	Step 1: +25°C ±2°C Step 2: -40°C ±2°C Step 3: +85°C ±2°C Step 4: +25°C ±2°C
		ESR	Less than or equal to 400% of the initial value	
	Step 3	△C	Less than or equal to 30% of the initial value	
		ESR	Less than or equal to the initial value	
		LC	Less than or equal to 4 times the initial value	
	Step 4	△C	Satisfies the range of 20% of the initial rating	
		ESR	Satisfies the initial value	
		LC	Satisfies the initial value	
Endurance	△C	Less than or equal to 30% of the initial value	Applied voltage: 2.7V Temperature: +85°C ±2°C Time: 1000h	
	ESR	Less than or equal to 4 times the initial value		
	LC	Less than or equal to the initial measurement		
	Appearance	No leakage or mechanical damage		
Cycle life	△C	Less than or equal to 30% of the initial value	Applied voltage: 2.7V Temperature: +25°C ±2°C Cycles: 500000	
	ESR	Less than or equal to 4 times the initial value		
Humidity Characteristics	△C	Satisfies the range of 30% of the initial rating	Temperature: +40°C ±2°C Relative humidity: 90~95%RH Test time: 240h	
	ESR	Less than or equal to 2 times the initial value		
	LC	Less than or equal to 4 times the initial value		
	Appearance	No leakage or mechanical damage		
Temperature cycle	C	Satisfies the initial value	Temperature cycle: -40°C ±2°C →normal temperature →+85°C ±2°C →normal temperature Cycles: 5	
	ESR	Satisfies the initial value		
	LC	Satisfies the initial value		
	Appearance	No mechanical damage or leakage		
Shelf life	C	Satisfies the range of 20% of the initial rating	Applied voltage: 0V Temperature: +85°C ±2°C Time: 1000h	
	ESR	Less than or equal to 3 times the initial value		
	LC	Less than or equal to the initial measurement		
	Appearance	No leakage or mechanical damage		
Self discharge characteristics (voltage holding characteristics)	Voltage between positive and negative poles ≥2.3V		Charging process: normal temperature, no load, rated voltage charge 24h Placement process: temperature less than or equal to 25 °C, relative humidity less than 60% RH, open 24 h	
Lead strength	No damage to the outlet			
Solder ability	More than 3/4 of the terminal surface is covered by a tin layer			

Storage Temperature: -30~50°C; Relative Humidity:<60%RH, Max. Humidity<85%RH

Supercapacitor

■ Standard Combined Type Supercapacitor

Specifications

Performance	Performance Characteristics	Notes
Capacitance Range	0.22~25F	$I=8^*CU_R(mA)$
Capacitance Tolerance	$\pm 20\%$, +80/-20%, +30/-10%	@25°C
Rated Voltage	5.5V	DC
Operating Temperature Range	-40°C ~+70°C	

Specifications Value of Standard Product

Part No.	Rated Voltage (V)	Capacitance (F)	Max. ESR DC 25°C (mΩ)	Nominal Current (25°C, A)	Maximum Peak Current (25°C<1s, A)	Leakage Current (25°C 72h, mA)
SC5V5Z224Z	5.5	0.22	1200	0.11	0.48	0.006
SC5V5Z474M	5.5	0.47	500	0.25	1.05	0.010
SC5V5Z4749	5.5	0.47	600	0.24	1.01	0.010
SC5V5Z105Z	5.5	1	400	0.51	1.96	0.013
SC5V5Z155M	5.5	1.5	220	0.77	3.10	0.015
SC5V5Z255M	5.5	2.5	160	1.27	4.91	0.016
SC5V5Z355M	5.5	3.5	150	1.74	6.31	0.028
SC5V5Z505M	5.5	5	120	2.46	8.59	0.030
SC5V5Z505M-1	5.5	5	120	2.46	8.59	0.030
SC5V5Z156M	5.5	15	100	6.35	16.50	0.078
SC5V5Z256M	5.5	25	40	11.46	34.38	0.096

■ Nominal Current: Is the current taking 5 sec. to discharge from U_R to $1/2U_R$.

■ Maximum Peak Current: Is the current taking 1 sec. to discharge from U_R to $1/2U_R$

Dimensions

Part No.	L (mm)	W (mm)	H (mm)	F (mm)	d (mm)
SC5V5Z224Z	13.5±0.5	6.5±0.5	13.8±1.0	9.0±0.5	0.5±0.05
SC5V5Z474M	13.5±1.0	6.5±0.5	13.8±1.0	9.0±0.5	0.5±0.05
SC5V5Z4749	17.0±0.5	8.5±0.5	14.0±1.0	12.0±0.5	0.6±0.05
SC5V5Z105Z	17.0±1.0	8.5±0.5	21.0±1.5	12.0±0.5	0.6±0.05
SC5V5Z155M	17.0±1.0	8.5±0.5	21.0±1.5	12.0±0.5	0.6±0.05
SC5V5Z255M	17.0±1.0	8.5±0.5	25.0±1.5	12.0±0.5	0.6±0.05
SC5V5Z355M	21.0±1.0	10.0±1.0	21.0±1.5	15.5±0.5	0.6±0.05
SC5V5Z505M	21.0±1.0	10.0±1.0	26.0±1.5	15.5±0.5	0.6±0.05
SC5V5Z505M-1	26.0±1.0	13.0±1.0	27.0±1.5	18.0±0.5	0.6±0.05
SC5V5Z156M	32.0±1.0	16.0±1.0	32.0±2.0	24.0±0.5	0.8±0.05
SC5V5Z256M	36.0±1.0	18.0±1.0	43.0±2.0	28.0±0.5	0.8±0.05

Outline and Dimensions

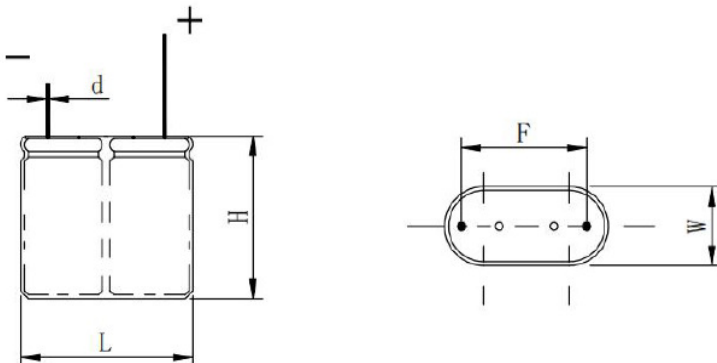

■ The actual size and tolerance shall be subject to the parameter table.

Supercapacitor

Packing Specification

Part No.	Plastic (EA)		
	Bag	Tray	Other
SC5V5Z224Z	800	-	-
SC5V5Z474M	1000	-	-
SC5V5Z4749	600	-	-
SC5V5Z105Z	500	-	-
SC5V5Z155M	500	-	-
SC5V5Z255M	400	-	-
SC5V5Z355M	400	-	-
SC5V5Z505M	250	-	-
SC5V5Z505M-1	200	-	-
SC5V5Z156M	-	36	-
SC5V5Z256M	-	-	Bulk

Environmental Characteristics

Item	Requirement		Test Condition	
Characteristics in different temperature	Step 2	ΔC	Less than or equal to 30% of the initial value	Step 1: +25°C ±2°C Step 2: -40°C ±2°C Step 3: +70°C ±2°C Step 4: +25°C ±2°C
		ESR	Less than or equal to 400% of the initial value	
	Step 3	ΔC	Less than or equal to 30% of the initial value	
		ESR	Less than or equal to the initial value	
		LC	Less than or equal to 4 times the initial value	
	Step 4	ΔC	Satisfies the range of 20% of the initial rating	
		ESR	Satisfies the initial value	
		LC	Satisfies the initial value	
	Endurance	ΔC	Less than or equal to 30% of the initial value	
ESR		Less than or equal to 4 times the initial value		
LC		Less than or equal to the initial measurement		
Appearance		No leakage or mechanical damage		
Cycle life	ΔC	Less than or equal to 30% of the initial value	Applied voltage: 5.5V Temperature: +25°C ±2°C Cycles: 500000	
	ESR	Less than or equal to 4 times the initial value		
Humidity Characteristics	ΔC	Satisfies the range of 30% of the initial rating	Temperature: +40°C ±2°C Relative humidity: 90~95%RH Test time: 240h	
	ESR	Less than or equal to 2 times the initial value		
	LC	Less than or equal to 4 times the initial value		
	Appearance	No leakage or mechanical damage		
Temperature cycle	C	Satisfies the initial value	Temperature cycle: -40°C ±2°C →normal temperature →+70°C ±2°C →normal temperature Cycles: 5	
	ESR	Satisfies the initial value		
	LC	Satisfies the initial value		
	Appearance	No mechanical damage or leakage		
Shelf life	C	Satisfies the range of 20% of the initial rating	Applied voltage: 0V Temperature: +70°C ±2°C Time: 1000h	
	ESR	Less than or equal to 3 times the initial value		
	LC	Less than or equal to the initial measurement		
	Appearance	No leakage or mechanical damage		
Self discharge characteristics (voltage holding characteristics)	Voltage between positive and negative poles ≥4.68V		Charging process: normal temperature, no load, rated voltage charge 24h Placement process: temperature less than or equal to 25 °C, relative humidity less than 60% RH, open 24 h	
Lead strength	No damage to the outlet			
Solder ability	More than 3/4 of the terminal surface is covered by a tin layer			

Storage Temperature: -30~50°C ; Relative Humidity:<60%RH, Max. Humidity<85%RH

Supercapacitor

■ High Voltage Combined Type Supercapacitor

Specifications

Performance	Performance Characteristics	Notes
Capacitance Range	0.5~5F	$I=8 \cdot C U_R$ (mA)
Capacitance Tolerance	±20%	@25°C
Rated Voltage	6.0V	DC
Operating Temperature Range	-40°C ~+70°C	

Specifications Value of Product

Part No.	Rated Voltage (V)	Capacitance (F)	Max. ESR DC 25°C (mΩ)	Nominal Current (25°C, A)	Maximum Peak Current (25°C<1s, A)	Leakage Current (25°C 72h, mA)
SC6V0Z504MV	6.0	0.5	800	0.28	1.15	0.010
SC6V0Z105MV	6.0	1	500	0.55	2.00	0.013
SC6V0Z505MV	6.0	5	150	2.61	8.57	0.032

■ Nominal Current: Is the current taking 5 sec. to discharge from U_R to $1/2U_R$.

■ Maximum Peak Current: Is the current taking 1 sec. to discharge from U_R to $1/2U_R$

Dimensions

Part No.	L (mm)	W (mm)	H (mm)	F (mm)	d (mm)
SC6V0Z504MV	13.5±0.5	6.5±0.5	13.8±1.0	9.0±0.5	0.5±0.05
SC6V0Z105MV	17.0±0.5	8.0±0.5	21.0±1.0	12.0±0.5	0.6±0.05
SC6V0Z505MV	21.0±1.0	10.0±1.0	26.0±1.5	15.5±0.5	0.6±0.05

Outline and Dimensions

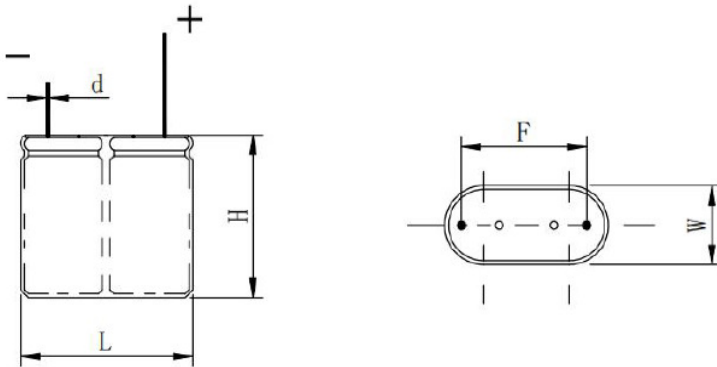

■ The actual size and tolerance shall be subject to the parameter table.

Packing Specification

Part No.	Plastic (EA)
	Bag
SC6V0Z504MV	800
SC6V0Z105MV	500
SC6V0Z505MV	250

Supercapacitor

■ Environmental Characteristics

Item	Requirement		Test Condition	
Characteristics in different temperature	Step 2	△C	Less than or equal to 30% of the initial value	Step 1: +25°C ±2°C Step 2: -40°C ±2°C Step 3: +70°C ±2°C Step 4: +25°C ±2°C
		ESR	Less than or equal to 400% of the initial value	
	Step 3	△C	Less than or equal to 30% of the initial value	
		ESR	Less than or equal to the initial value	
		LC	Less than or equal to 4 times the initial value	
	Step 4	△C	Satisfies the range of 20% of the initial rating	
		ESR	Satisfies the initial value	
LC		Satisfies the initial value		
Endurance	△C	Less than or equal to 30% of the initial value	Applied voltage: 6.0V Temperature: +70°C ±2°C Time: 1000h	
	ESR	Less than or equal to 4 times the initial value		
	LC	Less than or equal to the initial measurement		
	Appearance	No leakage or mechanical damage		
Cycle life	△C	Less than or equal to 30% of the initial value	Applied voltage: 6.0V Temperature: +25°C ±2°C Cycles: 500000	
	ESR	Less than or equal to 4 times the initial value		
Humidity Characteristics	△C	Satisfies the range of 30% of the initial rating	Temperature: +40°C ±2°C Relative humidity: 90~95%RH Test time: 240h	
	ESR	Less than or equal to 2 times the initial value		
	LC	Less than or equal to 4 times the initial value		
	Appearance	No leakage or mechanical damage		
Temperature cycle	C	Satisfies the initial value	Temperature cycle: -40°C ±2°C →normal temperature →+70°C ±2°C →normal temperature Cycles: 5	
	ESR	Satisfies the initial value		
	LC	Satisfies the initial value		
	Appearance	No mechanical damage or leakage		
Shelf life	C	Satisfies the range of 20% of the initial rating	Applied voltage: 0V Temperature: +70°C ±2°C Time: 1000h	
	ESR	Less than or equal to 3 times the initial value		
	LC	Less than or equal to the initial measurement		
	Appearance	No leakage or mechanical damage		
Self discharge characteristics (voltage holding characteristics)	Voltage between positive and negative poles ≥4.8V		Charging process: normal temperature, no load, rated voltage charge 24h, 8h(SC6V0Z105MV) Placement process: temperature less than or equal to 25 °C, relative humidity less than 60% RH, open 24 h	
Lead strength	No damage to the outlet			
Solder ability	More than 3/4 of the terminal surface is covered by a tin layer			

■ Storage Temperature: -30~50°C; Relative Humidity: <60%RH, Max. Humidity <85%RH

Supercapacitor

High Temperature Combined Type Supercapacitor

Specifications

Performance	Performance Characteristics	Notes
Capacitance Range	0.47~25F	$I=8 \cdot C U_R$ (mA)
Capacitance Tolerance	±20%	@25°C
Rated Voltage	5.5V	DC
Operating Temperature Range	-40°C ~+85°C	

Specifications Value of Product

Part No.	Rated Voltage (V)	Capacitance (F)	Max. ESR DC 25°C (mΩ)	Nominal Current (25°C, A)	Maximum Peak Current (25°C<1s, A)	Leakage Current (25°C 72h, mA)
SC5V5Z474MH	5.5	0.47	600	0.24	1.01	0.010
SC5V5Z155MH	5.5	1.5	220	0.77	3.10	0.015
SC5V5Z155MH-1	5.5	1.5	240	0.77	3.03	0.015
SC5V5Z205MH	5.5	2	200	1.02	3.93	0.016
SC5V5Z255MH	5.5	2.5	180	1.26	4.74	0.018
SC5V5Z355MH	5.5	3.5	150	1.74	6.31	0.028
SC5V5Z405MH	5.5	4	140	1.98	7.05	0.032
SC5V5Z505MH	5.5	5	140	2.41	8.09	0.036
SC5V5Z106MH	5.5	10	100	4.58	13.75	0.064
SC5V5Z256MH	5.5	25	70	10.19	25.00	0.120

■Nominal Current: Is the current taking 5 sec. to discharge from U_R to $1/2U_R$.

■Maximum Peak Current: Is the current taking 1 sec. to discharge from U_R to $1/2U_R$

Dimensions

Part No.	Figure	L (mm)	W (mm)	H (mm)	F (mm)	d (mm)
SC5V5Z474MH	1	13.5±1.0	6.5±0.5	13.8±1.0	9.0±0.5	0.5±0.05
SC5V5Z155MH	1	17.0±0.5	8.5±0.5	21.0±1.5	12.0±0.5	0.6±0.05
SC5V5Z155MH-1	2	18.0±1.0	9.6±1.0	24.0±1.0	12.0±0.5	0.6±0.20
SC5V5Z205MH	1	17.0±1.0	8.5±0.5	25.0±1.5	12.0±0.5	0.6±0.05
SC5V5Z255MH	1	17.0±1.0	8.5±0.5	25.0±1.5	12.0±0.5	0.6±0.05
SC5V5Z355MH	1	21.0±1.0	10.0±1.0	21.0±1.5	15.5±0.5	0.6±0.05
SC5V5Z405MH	1	21.0±1.0	10.0±1.0	26.0±1.5	15.5±0.5	0.6±0.05
SC5V5Z505MH	1	25.0±1.0	12.5±1.0	21.0±1.5	18.0±0.5	0.6±0.05
SC5V5Z106MH	1	32.0±1.0	16.0±1.0	27.0±2.0	24.0±0.5	0.8±0.05
SC5V5Z256MH	1	36.0±1.0	18.0±1.0	43.0±2.0	28.0±0.5	0.8±0.05

Outline and Dimensions

Fig.1

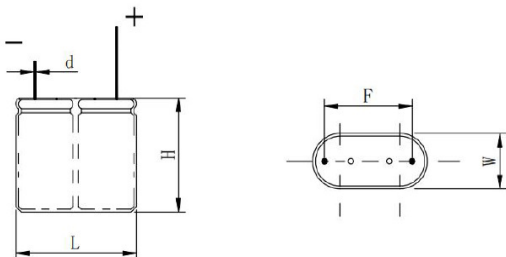
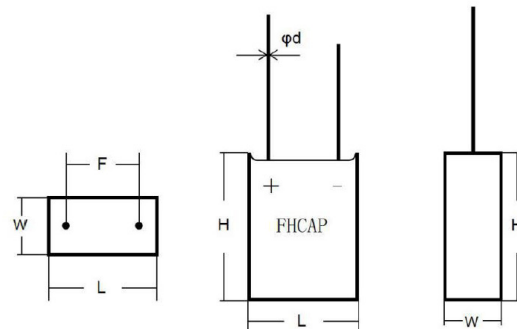

Fig.2



■The actual size and tolerance shall be subject to the parameter table.

Supercapacitor

Packing Specification

Part No.	Plastic (EA)		
	Bag	Tray	Other
SC5V5Z474MH	1000	-	-
SC5V5Z155MH	500	-	-
SC5V5Z155MH-1	-	78	-
SC5V5Z205MH	400	-	-
SC5V5Z255MH	400	-	-
SC5V5Z355MH	400	-	-
SC5V5Z405MH	250	-	-
SC5V5Z505MH	250	-	-
SC5V5Z106MH	-	36	-
SC5V5Z256MH	-	-	Bulk

Environmental Characteristics

Item	Requirement		Test Condition	
Characteristics in different temperature	Step 2	△C	Less than or equal to 30% of the initial value	Step 1: +25°C ±2°C Step 2: -40°C ±2°C Step 3: +85°C ±2°C Step 4: +25°C ±2°C
		ESR	Less than or equal to 400% of the initial value	
	Step 3	△C	Less than or equal to 30% of the initial value	
		ESR	Less than or equal to the initial value	
		LC	Less than or equal to 4 times the initial value	
	Step 4	△C	Satisfies the range of 20% of the initial rating	
		ESR	Satisfies the initial value	
		LC	Satisfies the initial value	
	Endurance	△C	Less than or equal to 30% of the initial value	
ESR		Less than or equal to 4 times the initial value		
LC		Less than or equal to the initial measurement		
Appearance		No leakage or mechanical damage		
Cycle life	△C	Less than or equal to 30% of the initial value	Applied voltage: 5.5V Temperature: +25°C ±2°C Cycles: 500000	
	ESR	Less than or equal to 4 times the initial value		
Humidity Characteristics	△C	Satisfies the range of 30% of the initial rating	Temperature: +40°C ±2°C Relative humidity: 90~95%RH Test time: 240h	
	ESR	Less than or equal to 2 times the initial value		
	LC	Less than or equal to 4 times the initial value		
	Appearance	No leakage or mechanical damage		
Temperature cycle	C	Satisfies the initial value	Temperature cycle: -40°C ±2°C →normal temperature →+85°C ±2°C →normal temperature Cycles: 5	
	ESR	Satisfies the initial value		
	LC	Satisfies the initial value		
	Appearance	No mechanical damage or leakage		
Shelf life	C	Satisfies the range of 20% of the initial rating	Applied voltage: 0V Temperature: +85°C ±2°C Time: 1000h	
	ESR	Less than or equal to 3 times the initial value		
	LC	Less than or equal to the initial measurement		
	Appearance	No leakage or mechanical damage		
Self discharge characteristics (voltage holding characteristics)	Voltage between positive and negative poles ≥4.68V		Charging process: normal temperature, no load, rated voltage charge 24h Placement process: temperature less than or equal to 25 °C, relative humidity less than 60% RH, open 24 h	
Lead strength	No damage to the outlet			
Solder ability	More than 3/4 of the terminal surface is covered by a tin layer			

■Storage Temperature: -30~50°C; Relative Humidity:<60%RH, Max. Humidity<85%RH

Supercapacitor

Measuring Method

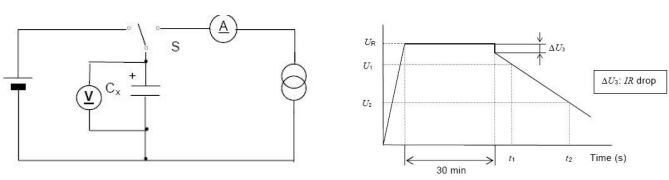
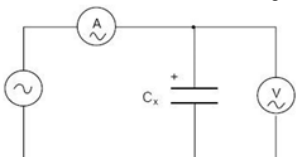
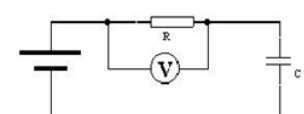
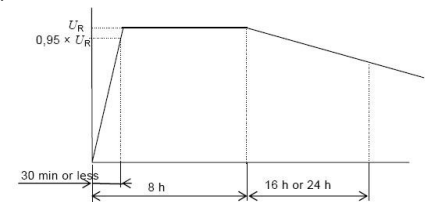
<p>Capacitance</p>	<p>Measurement by Permanent electrotransport :</p> <ol style="list-style-type: none"> 1.DC voltage of constant current/constant voltage source is set as rated voltage (UR). 2.Set the constant current value of the constant current discharge device. 3.Switch the switch S to dc power supply, and charge at constant voltage for 30min after the constant current/constant voltage source reaches the rated voltage. 4.After charging for 30min, switch S is changed to the constant exile device to discharge with constant current. 5.Measure the time t1 and t2 of the voltage from U1 to U2 at both ends of the capacitor, as shown in the figure, and calculate the capacitance value according to the following equation  $C = \frac{I \times (t_2 - t_1)}{U_1 - U_2}$
<p>Resistance</p>	<p>AC impedance measurement The circuit as shown in the figure below is used for measurement</p>  <p>Capacitor resistance Ra shall be computed by the type:</p> $R_a = \frac{U}{I}$ <p>Ra ac impedance (Ω); Effective value of U ac voltage (V R.M.S); Effective value of I ac current (V R.M.S).</p>
<p>Leakage Current</p>	<p>DC leakage current measurement principle is as follows</p>  <ol style="list-style-type: none"> 1.Discharge: before the measurement begins, the capacitor should be fully discharged.The discharge process lasts from 1h to 24h. 2. Leakage current shall be measured at rated temperature and rated voltage (UR).The charging voltage reached 95% after the maximum 30min charging time. The charging time was selected from 30min , 1h , 2h , 4h , 8h , 12h , 24h , 48h , 72h and shall be specified in the detail specification 3.Stable power supply, such as dc stabilized power supply, should be used. 4. through the protection under 1000 Ω resistance to capacitor voltage
<p>Self discharge</p>	<p>Before the measurement begins, the capacitor should be fully discharged. The discharge process lasts from 1h to 24h. The rated voltage U should be directly applied at both ends of the capacitor, without protection resistance. Capacitors should be placed at standard ambient temperature and pressure for 24 hours. DC voltmeter internal resistance should be greater than 1 MΩ.</p> 

Supercapacitor

■ Soldering Condition

The welding condition of the proposed product is flow welding, as shown below:

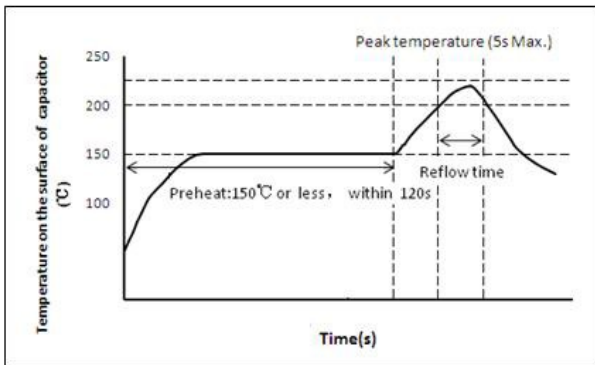

Care should be taken when welding:

1. Carry out low-temperature welding in accordance with the above welding conditions within a short time.
2. When the voltage is above 0.3V, do not backflow welding
3. Please consult us for more conditions of reflow soldering.

■ Cautions For Use

1. Polarity problem of supercapacitor

Unlike ordinary electrolytic capacitors or batteries, the anode and cathode of supercapacitors are made of the same material, so there is no polarity in theory. However, the polarity indicated by super capacitors is formulated by the manufacturer in the production process. When the capacitor is used carelessly in the short-term reverse operation, it will not cause substantial damage to the capacitor. If adjusted to a positive direction, it can be guaranteed to be used, but it cannot be used in the long-term reverse operation, which will result in the rapid attenuation of capacitor life characteristics.

2. On the issue of supercapacitor charging

Charging of supercapacitors requires dc voltage which does not exceed rated voltage, and various charging methods such as current limit, constant current, constant power and constant voltage can be adopted. Supercapacitors can be charged by lowering the voltage of the charging power supply until the capacitors are full enough to maintain voltage balance.

3. The problem of internal resistance and capacity of supercapacitors

In the process of charging and discharging, super capacitor resistance caused by the IR drop, lose efficiency of capacitor charging and discharging, so the size of capacitor resistance to a certain extent, determines the actor bad of character of capacitor, due to the internal resistance of the super capacitor than normal capacitors, in the process of communication charge and discharge circuit or high frequency, capacitor will fever, cause life decay quickly, which is the cause of the super capacitor only commonly used in dc.

Compared with ordinary capacitors, supercapacitors have a larger time constant, so the charge-discharge time is relatively long, and because of this, it is not suitable for continuous large current to work frequently, which will cause rapid attenuation of the heating performance. The frequency characteristic of supercapacitors is that the response time of positive and negative ions in the micro pores of carbon electrode is long at high frequency. Instead of measuring capacitors' ac capacity, the mAh method based on battery measurement is used.

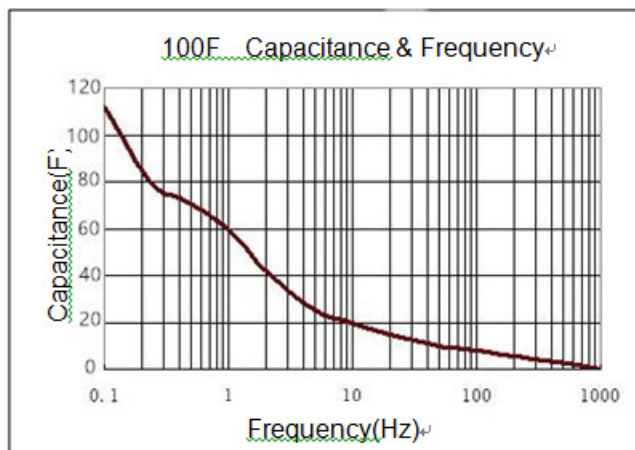

except Lithium ion

4. Transport and storage

Should prevent products be affected with damp be affected with damp in product transportation, storage temperature should be - 30 °C to 50 °C, relative humidity less than 60%, the maximum humidity no more than 85%, otherwise it will cause capacitance performance degradation of be affected with damp be affected with damp or rust.

Lithium ion :The Super Capacitor should be stored at room temperature, charged to about 50% ~ 80% of capacity; We recommend that Asymmetry Super Capacitor be charged about once per half a year to prevent over discharge.

Should prevent products be affected with damp be affected with damp in product transportation, storage temperature should be -20 °C to 50 °C, relative humidity less than 65%, the maximum humidity no more than 65%, otherwise it will cause capacitance performance degradation of be affected with damp be affected with damp or rust.

Supercapacitor

5. Installation and welding

When the supercapacitor is used on the double-sided circuit board, it should be noted that the connection cannot pass through the reach of the capacitor, otherwise the product will be short circuit overvoltage and the capacitor will be damaged. During installation and after installation, do not twist or tilt the capacitor by force. Do not pull the lead by force. Break the needle and weld after bending. In the welding process to avoid overheating of the capacitor (1.6 mm of printed circuit board, the welding should be 260 °C, when time is not more than 5 s), after welding, circuit board and the capacitor to clean in the net.

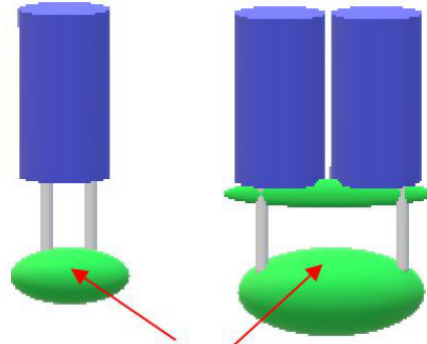

try not to wire here

6. Short circuit judgment of supercapacitor

The short circuit capacitance shall not be charged or discharged. The dc voltage shall be applied between the positive and negative terminals of the capacitance. The capacitance voltage shall not be increased. When charging, it is normal to use ohm gauge (short circuit block) indicator as short circuit state. Capacitance is short circuit and it cannot be determined. It should be observed whether the resistance value increases or not.

7. Series and parallel operation problem

When the same super capacitor is used in series, the total voltage = series number * monomer withstand voltage; Total capacity = unit capacity Total energy = series number x monomer capacity, total internal resistance = series number x monomer resistance.

There is a problem of voltage balancing between three or more monomers in series, so it is necessary to consider adopting equalizing circuit to ensure that the capacitance cannot be used over voltage during long-term use, thus causing capacitor life attenuation and damage.

Supercapacitors of different specifications cannot be used in series.

When the super capacitors are used in parallel, they can be connected in parallel with different capacitance values and charged by the same voltage. However, it is necessary to pay attention to the current balance between the capacitors and to isolate each other, so as to avoid reverse charging due to the potential difference after discharge.

8. For other problems in use, please consult the manufacturer or refer to the relevant technical data of the instructions for the use of supercapacitors.

9. Handling of leakage situation

Skin contact: rinse skin thoroughly with soap and water;

Eye contact: flush with flowing water or normal saline and seek medical advice; Absorb: immediately rinse with water and seek medical advice;

If the supercapacitor is found to be overheating or smelling, the power supply and load connected to the supercapacitor should be disconnected immediately to cool it, and the supercapacitor should be treated properly so that no face or hand contact with the supercapacitor is allowed.

X-ON Electronics

Largest Supplier of Electrical and Electronic Components

Click to view similar products for [Supercapacitors](#) / [Ultracapacitors](#) category:

Click to view products by [Viking](#) manufacturer:

Other Similar products are found below :

[BZ12GA154ZHB](#) [BZ195B273ZNBDM](#) [C-TEC1225 P](#) [KR-5R5C105H-R](#) [SCCY73B407SLBLE](#) [BRP002R8L105FC](#) [MAL223551014E3](#)
[MAL223551007E3](#) [MAL223551001E3](#) [CPM3225A-2K](#) [iMOD054V062P3L-11A](#) [SCCS30B126SRB](#) [HSL0814-3R8106-R](#) [SC5V5Z255M](#)
[DB5U207M30045HA](#) [DRE10/2.5](#) [DRL106S0TI25RRDAP](#) [DRL226S0TK25RR](#) [106DCN2R7M](#) [SCCR20B335SRB](#) [SCCT30B156SRB](#)
[SCCU30B306MRB](#) [SCMR14C474MRBA0](#) [SCMR14C474MSBA0](#) [SCMR22C155MRBA0](#) [SCMR22C155MSBA0](#) [SCMS22C255MRBA0](#)
[SCMT22C505MRBA0](#) [SCMT32C755MRBA0](#) [FT0H225ZF](#) [DZ-2R5D105G4T](#) [MAL219612473E3](#) [SCCV40B506MRB](#) [DBJ-5R5D224T](#)
[GW209F](#) [TV1020-3R0605-R](#) [TV1245-3R0346-R](#) [SCCX50B207VSB](#) [PAS0815LS2R5105](#) [MAL222091006E3](#) [MAL222091008E3](#)
[SCCY62B307VSB](#) [SCMR18C105MSBA0](#) [EEC-HL0E107](#) [EEC-HL0E506](#) [SCMR18D105MRBB0](#) [MAL219691154E3](#) [HVZ0E107NF-LT](#)
[MAL219632224E3](#) [HVZ0E106NF](#)