

Metallized Polyester Film Capacitors

MKT Radial Epoxy Lacquered Type

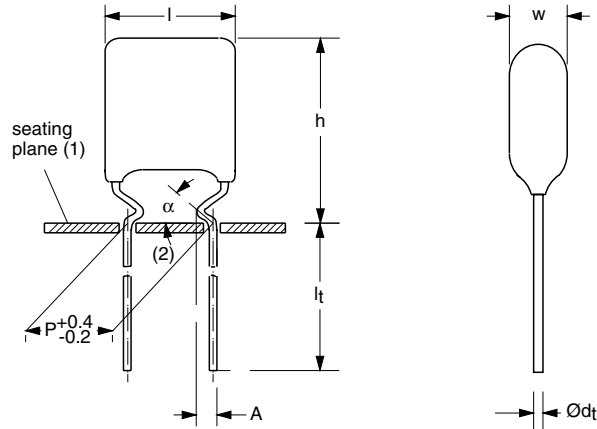

Dimensions in mm

(1) Hole \varnothing 1.0 for $d_t = 0.5$ mm

(2) $0 \leq \alpha < 50^\circ$

(3) $A = 1.7 \pm 0.3$ mm

APPLICATIONS

Blocking and coupling. Bypass and energy reservoir

MARKING

C-value; tolerance; rated voltage

DIELECTRIC

Polyester film

ELECTRODES

Vacuum deposited aluminum

COATING

Flame retardant epoxy material (UL-class 94 V-0)

CONSTRUCTION

Wound mono construction

LEADS

Tinned wire

CAPACITANCE RANGE (E12 SERIES)

0.0033 to 1.0 μ F

FEATURES

Available taped and loose in box

Lead (Pb)-free product

RoHS-compliant product

CAPACITANCE TOLERANCE

$\pm 10\%$; $\pm 5\%$

RATED (DC) VOLTAGE

63 V; 100 V; 250 V; 400 V

RATED (AC) VOLTAGE

40 V; 63 V; 160 V; 220 V

CLIMATIC CATEGORY

55/105/56

RATED TEMPERATURE

85 °C

MAXIMUM APPLICATION TEMPERATURE

105 °C

REFERENCE SPECIFICATIONS

IEC 60384-2

PERFORMANCE GRADE

Grade 1 (long life)

DETAIL SPECIFICATION

For more detailed data and test requirements contact:

filmcaps.roeselare@vishay.com



RoHS
COMPLIANT

COMPOSITION OF CATALOG NUMBER

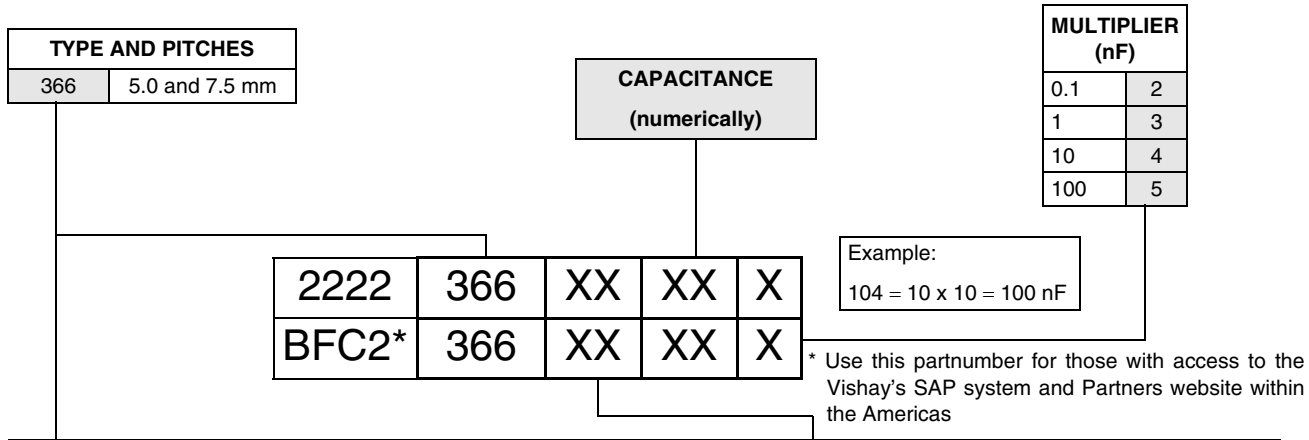

TYPE	PACKAGING	LEAD CONFIGURATION	ON REQUEST				
			C-TOL	63 V	100 V	250 V	400 V
Pitch = 5.0 mm							
366	loose in box	kinked leads 4.0 + 1.0/- 0.5 mm	± 10 %	75	85	–	–
			± 5 %	76	86	–	–
		kinked leads 17.0 ± 4.0 mm	± 10 %	71	81	–	–
			± 5 %	72	82	–	–
Pitch = 7.5 mm							
ON REQUEST							
366	loose in box	kinked leads 4.0 + 1.0/- 0.5 mm	± 10 %	15	25	45	55
			± 5 %	16	26	46	56
		kinked leads 17.0 ± 4.0 mm	± 10 %	11	21	41	51
			± 5 %	12	22	42	52
	ammopack	kinked leads; H = 16.0 mm; P ₀ = 12.7 mm	± 10 %	13	23	43	53
			± 5 %	17	27	47	57

SPECIFIC REFERENCE DATA

DESCRIPTION	VALUE			
	at 1 kHz	at 10 kHz	at 100 kHz	
Tangent of loss angle:				
C ≤ 0.47 μF	≤ 75 × 10 ⁻⁴	≤ 130 × 10 ⁻⁴	≤ 225 × 10 ⁻⁴	
0.47 μF < C ≤ 1.0 μF	≤ 75 × 10 ⁻⁴	≤ 130 × 10 ⁻⁴	–	
Rated voltage pulse slope (dU/dt) _R	at 63 V (DC)	at 100 V (DC)	at 250 V (DC)	at 400 V (DC)
	110 V/μs	110 V/μs	130 V/μs	170 V/μs
R between leads, for C ≤ 0.33 μF:				
at 10 V; 1 minute	> 15000 MΩ			
at 100 V; 1 minute		> 15000 MΩ	> 30000 MΩ	> 30000 MΩ
RC between leads, for C > 0.33 μF at 10 V; 1 minute	> 5000 s	> 5000 s		
R between interconnecting leads and casing; 100 V; 1 minute	> 30000 MΩ	> 30000 MΩ	> 30000 MΩ	> 30000 MΩ
Withstanding (DC) voltage (cut off current 10 mA); rise time 100 V/s	100 V; 1 minute	160 V; 1 minute	400 V; 1 minute	640 V; 1 minute



Metallized Polyester Film Capacitors Vishay BCcomponents
MKT Radial Epoxy Lacquered Type

$U_{Rdc} = 63 V$; $U_{Rac} = 40 V$

C (μF)	DIMENSIONS $W_{max} \times H_{max} \times L_{max}$ (mm)	MASS (g)	CATALOG NUMBER 2222 366 AND PACKAGING						
			LOOSE IN BOX				AMMOPACK		
			It = 4.0 + 1.0/- 0.5 mm		It = 17.0 ± 4.0 mm		H = 16.0 mm		
			C-TOL = ± 10 %	C-TOL = ± 5 %	SPQ	SPQ	C-TOL = ± 10 %	C-TOL = ± 5 %	SPQ
last 5 digits of catalog number		last 5 digits of catalog number				last 5 digits of catalog number			
Pitch = 5.0 + 0.4/- 0.2 mm; $d_t = 0.50 \pm 0.05$ mm									
0.047	4.0 × 12.5 × 7.3	0.3	75473	76473	1000	1000			
0.056			75563	76563					
0.068			75683	76683					
0.082			75823	76823					
0.1			75104	76104					
0.12			75124	76124					
0.15	4.0 × 13.0 × 7.3	0.3	75154	76154	1000	1000			
0.18	4.0 × 13.5 × 7.3	0.4	75184	76184	1000	1000			
0.22	4.2 × 13.5 × 7.3	0.4	75224	76224	1000	1000			
0.27	4.5 × 14.0 × 7.3	0.4	75274	76274	1000	1000			
0.33	4.5 × 14.5 × 7.3	0.4	75334	76334	1000	1000			
0.39			75394	76394					
0.47	4.5 × 15.5 × 7.3	0.4	75474	76474	1000	1000			
0.56	5.0 × 14.0 × 7.3	0.4	75564	76564	1000	1000			
0.68	5.5 × 14.5 × 7.3	0.4	75684	76684	1000	1000			
0.82	5.5 × 15.0 × 7.3	0.5	75824	76824	1000	1000			
1.0	5.5 × 15.5 × 7.3	0.5	75105	76105	1000	1000			
Pitch = 7.5 + 0.4/- 0.2 mm; $d_t = 0.60 \pm 0.06$ mm									
0.12	4.0 × 12.0 × 10.0	0.4	15124	16124	1000	1000	13124	17124	1500
0.15			15154	16154			13154	17154	
0.18			15184	16184			13184	17184	
0.22			15224	16224			13224	17224	
0.27	4.5 × 13.0 × 10.5	0.5	15274	16274	1000	1000	13274	17274	1250
0.33	5.0 × 13.5 × 10.5	0.6	15334	16334	1000	1000	13334	17334	1000
0.39		0.4	15394	16394			13394	17394	
0.47	5.5 × 14.0 × 10.5	0.7	15474	16474	1000	1000	13474	17474	1000
0.56	5.5 × 14.5 × 10.5	0.8	15564	16564	1000	1000	13564	17564	1000
0.68			15684	16684			13684	17684	
0.82			15824	16824			13824	17824	
1.0			15105	16105			13105	17105	

$U_{Rdc} = 100\text{ V}$; $U_{Rac} = 63\text{ V}$

C (μF)	DIMENSIONS $W_{max} \times H_{max} \times L_{max}$ (mm)	MASS (g)	CATALOG NUMBER 2222 366 AND PACKAGING						
			LOOSE IN BOX				AMMOPACK		
			It = 4.0 + 1.0/- 0.5 mm		It = 17.0 \pm 4.0 mm		H = 16.0 mm		
			C-TOL = $\pm 10\%$	C-TOL = $\pm 5\%$	SPQ	SPQ	C-TOL = $\pm 10\%$	C-TOL = $\pm 5\%$	SPQ
			last 5 digits of catalog number	last 5 digits of catalog number			last 5 digits of catalog number	last 5 digits of catalog number	
Pitch = 5.0 + 0.4/- 0.2 mm; $d_t = 0.50 \pm 0.05\text{ mm}$									
0.01	4.5 \times 12.5 \times 7.3	0.3	85103	86103	1000	1000			
0.012			85123	86123					
0.015			85153	86153					
0.018			85183	86183					
0.022			85223	86223					
0.027			85273	86273					
0.033			85333	86333					
0.039			85393	86393					
0.047	4.5 \times 12.5 \times 7.3	0.3	85473	86473	1000	1000			
0.056			85563	86563					
0.068			85683	86683					
0.082	4.5 \times 13.0 \times 7.3	0.3	85823	86823	1000	1000			
0.1	4.5 \times 13.5 \times 7.3	0.4	85104	86104	1000	1000			
0.12			85124	86124					
0.15			85154	86154					
0.18			85184	86184					
0.22	4.5 \times 13.5 \times 7.3	0.4	85224	86224	1000	1000			
0.27	4.5 \times 14.0 \times 7.3	0.4	85274	86274	1000	1000			
Pitch = 7.5 + 0.4/- 0.2 mm; $d_t = 0.60 \pm 0.06\text{ mm}$									
0.039	4.0 \times 12.0 \times 10.0	0.4	25393	26393	1000	1000	23393	27393	1500
0.047			25473	26473			23473	27473	
0.056			25563	26563			23563	27563	
0.068			25683	26683			23683	27683	
0.082			25823	26823			23823	27823	
0.1	4.0 \times 13.0 \times 10.0	0.4	25104	26104	1000	1000	23104	27104	1500
0.12	4.5 \times 13.0 \times 10.5	0.5	25124	26124	1000	1000	23124	27124	1250
0.15	5.0 \times 13.0 \times 10.5	0.6	25154	26154	1000	1000	23154	27154	1000
0.18	5.0 \times 13.5 \times 10.5	0.6	25184	26184	1000	1000	23184	27184	1000
0.22	5.5 \times 13.5 \times 10.5	0.7	25224	26224	1000	1000	23224	27224	1000
0.27	6.0 \times 14.5 \times 10.5	0.7	25274	26274	1000	1000	23274	27274	1000
0.33	6.0 \times 15.0 \times 10.5	0.7	25334	26334	1000	1000	23334	27334	1000
0.39			25394	26394			23394	27394	
0.47			25474	26474			23474	27474	



Metallized Polyester Film Capacitors Vishay BCcomponents
MKT Radial Epoxy Lacquered Type

$U_{Rdc} = 250\text{ V}$; $U_{Rac} = 160\text{ V}$

C (μF)	DIMENSIONS $W_{max} \times H_{max} \times L_{max}$ (mm)	MASS (g)	CATALOG NUMBER 2222 366 AND PACKAGING						
			LOOSE IN BOX				AMMOPACK		
			It = 4.0 + 1.0/- 0.5 mm		It = 17.0 ± 4.0 mm		H = 16.0 mm		
			C-TOL = ± 10 %	C-TOL = ± 5 %	SPQ	SPQ	C-TOL = ± 10 %	C-TOL = ± 5 %	SPQ
last 5 digits of catalog number	last 5 digits of catalog number	last 5 digits of catalog number	last 5 digits of catalog number						
Pitch = 7.5+0.4/-0.2 mm; $d_t = 0.60 \pm 0.06\text{ mm}$									
0.018	4.0 × 13.0 × 10.0	0.4	45183	46183	1000	1000	43183	47183	1500
0.022			45223	46223			43223	47223	
0.027			45273	46273			43273	47273	
0.033			45333	46333			43333	47333	
0.039			45393	46393			43393	47393	
0.047			45473	46473			43473	47473	
0.056	4.0 × 14.0 × 10.0	0.7	45563	46563	1000	1000	43563	47563	1500
0.068	4.5 × 14.0 × 10.0	0.7	45683	46683	1000	1000	43683	47683	1250
0.082	4.5 × 13.0 × 10.0	0.5	45823	46823	1000	1000	43823	47823	1250
0.1	5.0 × 13.5 × 10.0	0.6	45104	46104	1000	1000	43104	47104	1000
0.12	5.5 × 14.0 × 10.0	0.6	45124	46124	1000	1000	43124	47124	1000
0.15	5.5 × 15.5 × 10.0	0.7	45154	46154	1000	1000	43154	47154	1000

$U_{Rdc} = 400\text{ V}$; $U_{Rac} = 220\text{ V}$

C (μF)	DIMENSIONS $W_{max} \times H_{max} \times L_{max}$ (mm)	MASS (g)	CATALOG NUMBER 2222 366 AND PACKAGING						
			LOOSE IN BOX				AMMOPACK		
			It = 4.0 + 1.0/- 0.5 mm		It = 17.0 ± 4.0 mm		H = 16.0 mm		
			C-TOL = ± 10 %	C-TOL = ± 5 %	SPQ	SPQ	C-TOL = ± 10 %	C-TOL = ± 5 %	SPQ
last 5 digits of catalog number	last 5 digits of catalog number	last 5 digits of catalog number	last 5 digits of catalog number						
Pitch = 7.5+0.4/-0.2 mm; $d_t = 0.60 \pm 0.06\text{ mm}$									
0.0033	4.0 × 12.0 × 10.0	0.4	55332	56332	1000	1000	53332	57332	1500
0.0039			55392	56392			53392	57392	
0.0047			55472	56472			53472	57472	
0.0056	4.0 × 13.0 × 10.0	0.4	55562	56562	1000	1000	53562	57562	1500
0.0068			55682	56682			53682	57682	
0.0082			55822	56822			53822	57822	
0.01			55103	56103			53103	57103	
0.012			55123	56123			53123	57123	
0.015			55153	56153			53153	57153	
0.018	4.5 × 13.5 × 10.0	0.6	55183	56183	1000	1000	53183	57183	1250
0.022	5.0 × 14.0 × 10.0	0.7	55223	56223	1000	1000	53223	57223	1000
0.027	4.0 × 12.5 × 10.0	0.4	55273	56273	1000	1000	53273	57273	1500
0.033	4.5 × 13.0 × 10.0	0.5	55333	56333	1000	1000	53333	57333	1250
0.039	5.0 × 13.5 × 10.0	0.5	55393	56393	1000	1000	53393	57393	1000
0.047	5.0 × 13.5 × 10.0	0.6	55473	56473	1000	1000	53473	57473	1000
0.056	5.5 × 14.0 × 10.0	0.7	55563	56563	1000	1000	53563	57563	1000

MAXIMUM RMS VOLTAGE (SINEWAVE) AS A FUNCTION OF FREQUENCY

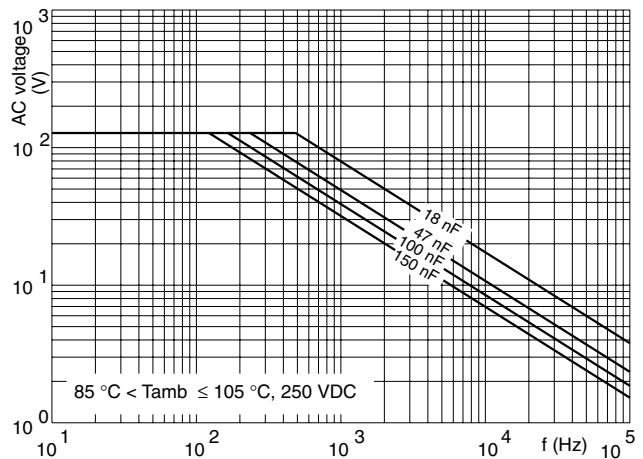
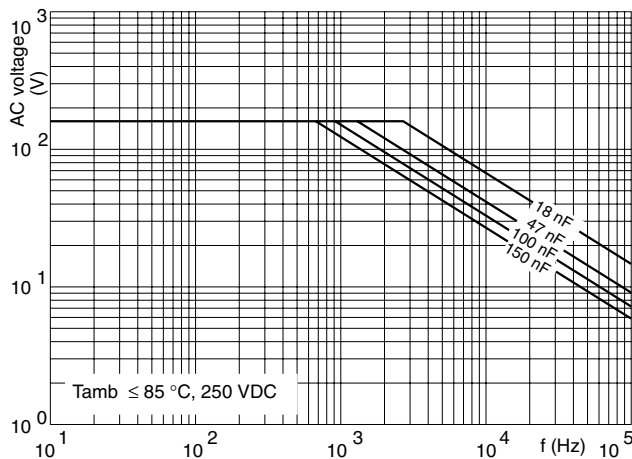
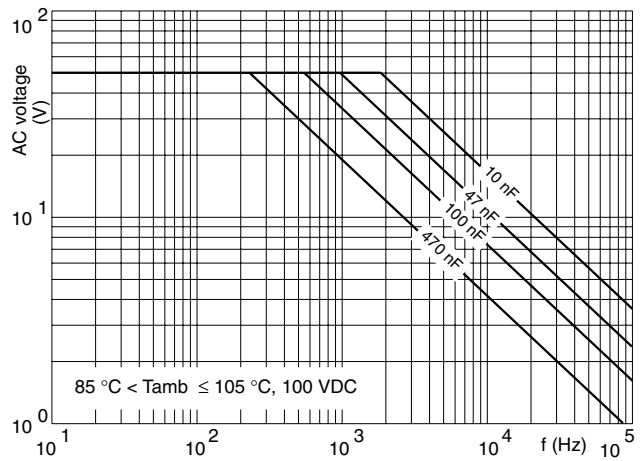
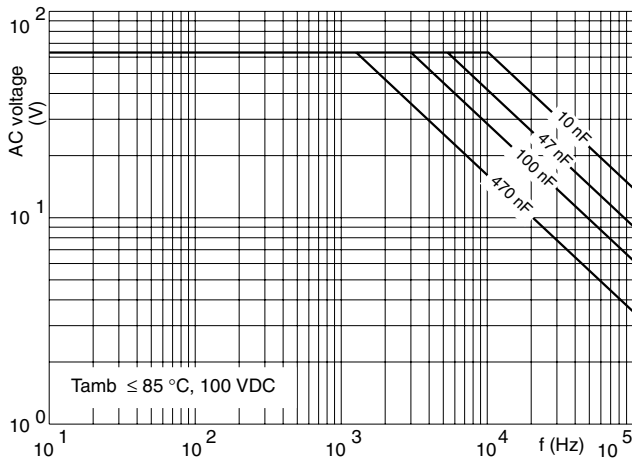
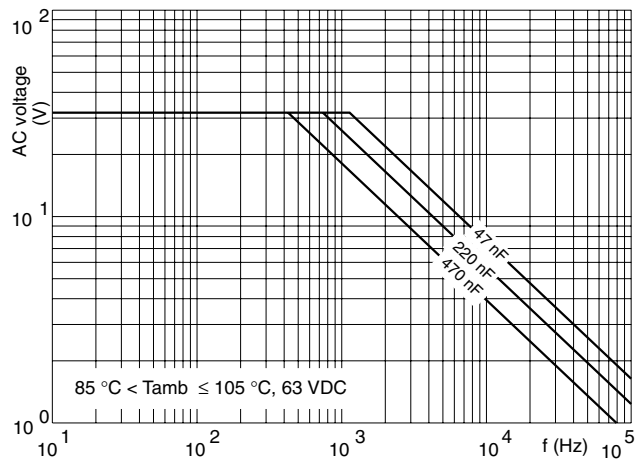
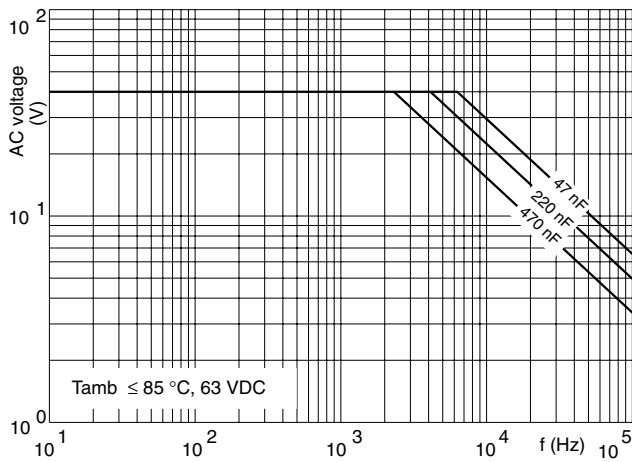



Metallized Polyester Film Capacitors Vishay BCcomponents
MKT Radial Epoxy Lacquered Type

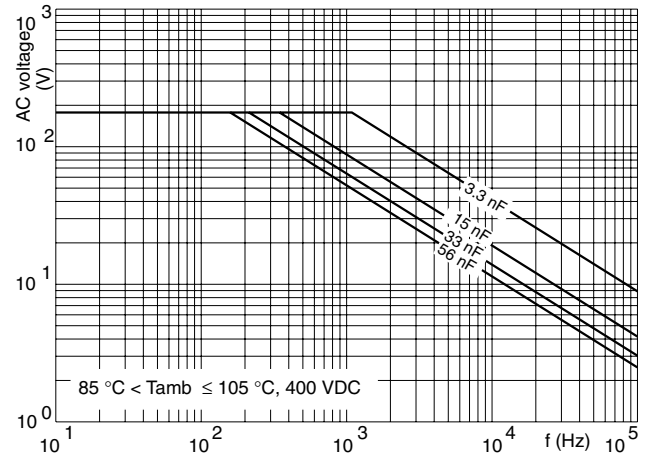
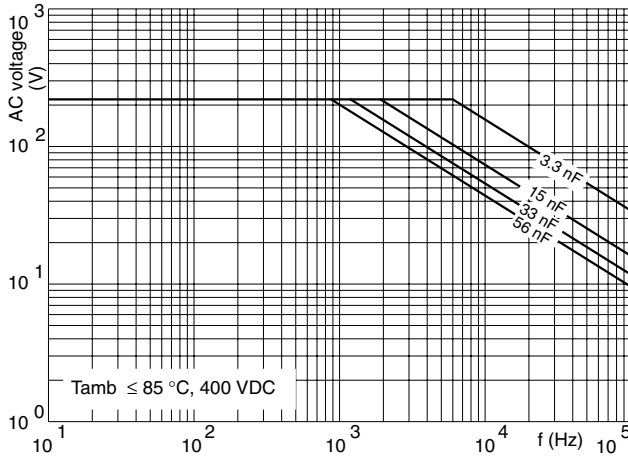

CAPACITANCE

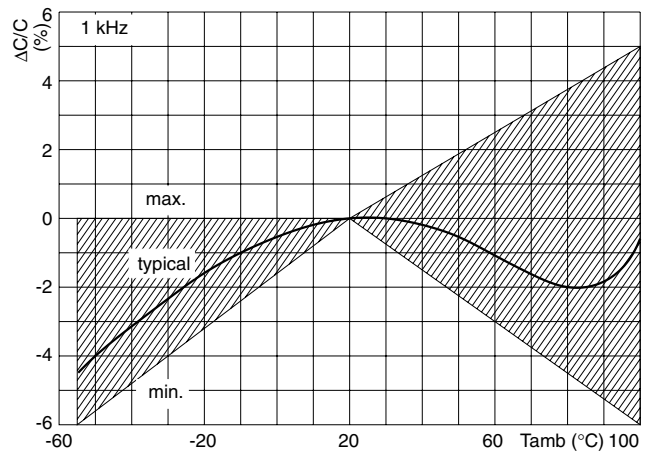
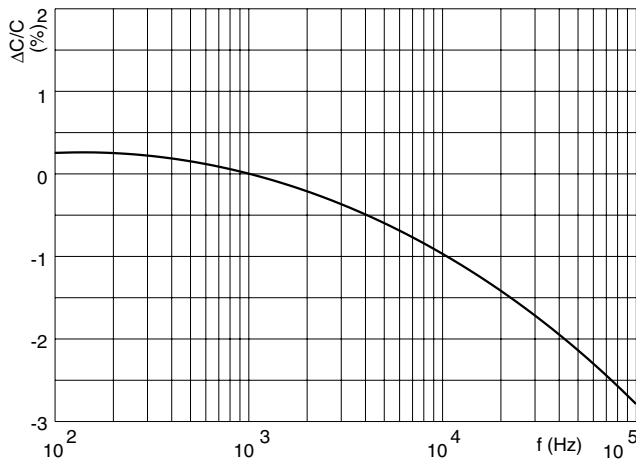

IMPEDANCE

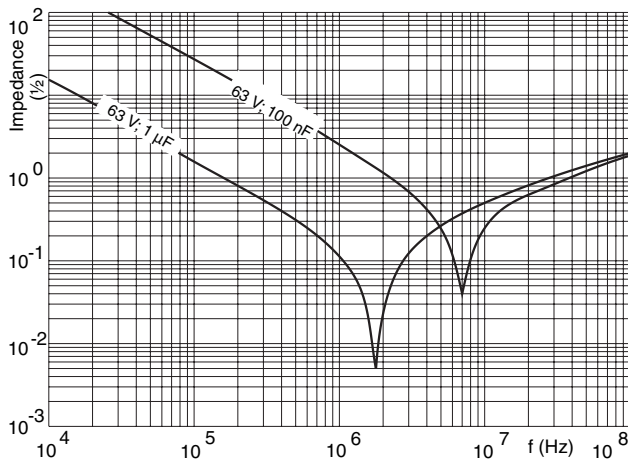



Disclaimer

All product specifications and data are subject to change without notice.

Vishay Intertechnology, Inc., its affiliates, agents, and employees, and all persons acting on its or their behalf (collectively, "Vishay"), disclaim any and all liability for any errors, inaccuracies or incompleteness contained herein or in any other disclosure relating to any product.

Vishay disclaims any and all liability arising out of the use or application of any product described herein or of any information provided herein to the maximum extent permitted by law. The product specifications do not expand or otherwise modify Vishay's terms and conditions of purchase, including but not limited to the warranty expressed therein, which apply to these products.

No license, express or implied, by estoppel or otherwise, to any intellectual property rights is granted by this document or by any conduct of Vishay.

The products shown herein are not designed for use in medical, life-saving, or life-sustaining applications unless otherwise expressly indicated. Customers using or selling Vishay products not expressly indicated for use in such applications do so entirely at their own risk and agree to fully indemnify Vishay for any damages arising or resulting from such use or sale. Please contact authorized Vishay personnel to obtain written terms and conditions regarding products designed for such applications.

Product names and markings noted herein may be trademarks of their respective owners.

X-ON Electronics

Largest Supplier of Electrical and Electronic Components

Click to view similar products for [Film Capacitors](#) category:

Click to view products by [Vishay](#) manufacturer:

Other Similar products are found below :

[F339X134748MIP2T0](#) [F450KG153J250ALH0J](#) [750-1018](#) [FKP1-1500160010P15](#) [FKP1R031007D00JYSD](#) [FKP1R031507E00JYSD](#)
[FKP1U024707E00KYSD](#) [82DC4100CK60J](#) [82EC1100DQ50K](#) [PFR5101J100J11L16.5TA18](#) [PME261JB5220KR19T0](#) [A451GK223M040A](#)
[A561ED221M450A](#) [QXJ2E474KTPT](#) [QXL2B333KTPT](#) [R49AN347000A1K](#) [EEC2G505HQA406](#) [B25668A6676A375](#) [B25673A4282E140](#)
[BFC233868148](#) [BFC2370GC222](#) [C3B2AD44400B20K](#) [C4ASWBU3220A3EK](#) [CB027C0473J--](#) [CB177I0184J--](#) [CB182K0184J--](#) [23PW210](#)
[950CQW5H-F](#) [SBDC3470AA10J](#) [SCD105K122A3-22](#) [2N3155](#) [A571EH331M450A](#) [FKP1-2202KV5P15](#) [FKS3-680040010P10](#)
[QXL2E473KTPT](#) [445450-1](#) [B25669A3996J375](#) [46KI322000M1M](#) [46KR415050M1K](#) [4BSNBX4100ZBFJ](#) [MKP383510063JKP2T0](#)
[MKPY2-.02230020P15](#) [MKT 1813-368-015](#) [4055292001](#) [46KN410000N1K](#) [EEC2E106HQA405](#) [EEC2G205HQA402](#) [EEC2G805HQA415](#)
[P409CP224M250AH470](#) [82EC2150DQ50K](#)