

Industrial Rotary Position Sensor Bushing Mount Type, Conductive Plastic

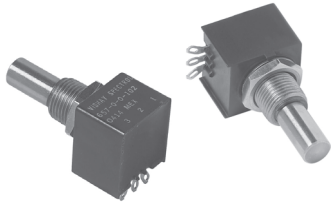



FEATURES

- Fully sealed for high immunity to environmental damage
- Excellent temperature stability
- Rotational life exceeds 2 million revolutions
- Low cost and wide range of options
- Stainless steel shaft
- Shock to 30 G's vibration to 15 G's at 10 to 2000 Hz

ELECTRICAL SPECIFICATIONS	
PARAMETER	
Standard Resistance	1 k Ω to 100 k Ω
Capability Range	200 k Ω
Resistance Tolerance	$\pm 20\%$
Linearity	$\pm 2\%$
Power Rating	1.0 W at 85 °C
Electrical Travel	240° \pm 4°
Dielectric Withstanding	500 V _{RMS} at 60 Hz minimum
Output Smoothness	0.2 % maximum

MECHANICAL SPECIFICATIONS	
PARAMETER	
Bearing Type	Sleeve
Mechanical Rotation	250° \pm 2°
Stop Strength	10 in - lb minimum 11.5 kg/cm
Starting Torque	3.0 oz. - in maximum 216 g/cm
Running Torque	3.0 oz. - in maximum 216 g/cm

ORDERING INFORMATION/DESCRIPTION							
657	B	F	0			50 k Ω	BO10
MODEL	STYLE	SHAFT OPTIONS	SHAFT BUSHING OPTIONS			TOTAL RESISTANCE	PACKAGING
	B: Bushing	R - Round F - Flatted	 Shaft Length 0 - 0.875" FMS 1 - 0.625" FMS 2 - 1.000" FMS 3 - 1.250" FMS	 Bushing Length 0.375" FMS 0.250" FMS 0.500" FMS 0.750" FMS	 Flat 0.440" 0.315" 0.440" 0.440"		Box of 10 pieces

SAP PART NUMBERING GUIDELINES				
657B	R	1	103	BO10
MODEL	END SHAFT	SHAFT AND BUSHING OPTIONS	OHMIC VALUE	PACKAGING
	R: Round	(see above)		

DIMENSIONS in inches (millimeters)

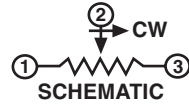
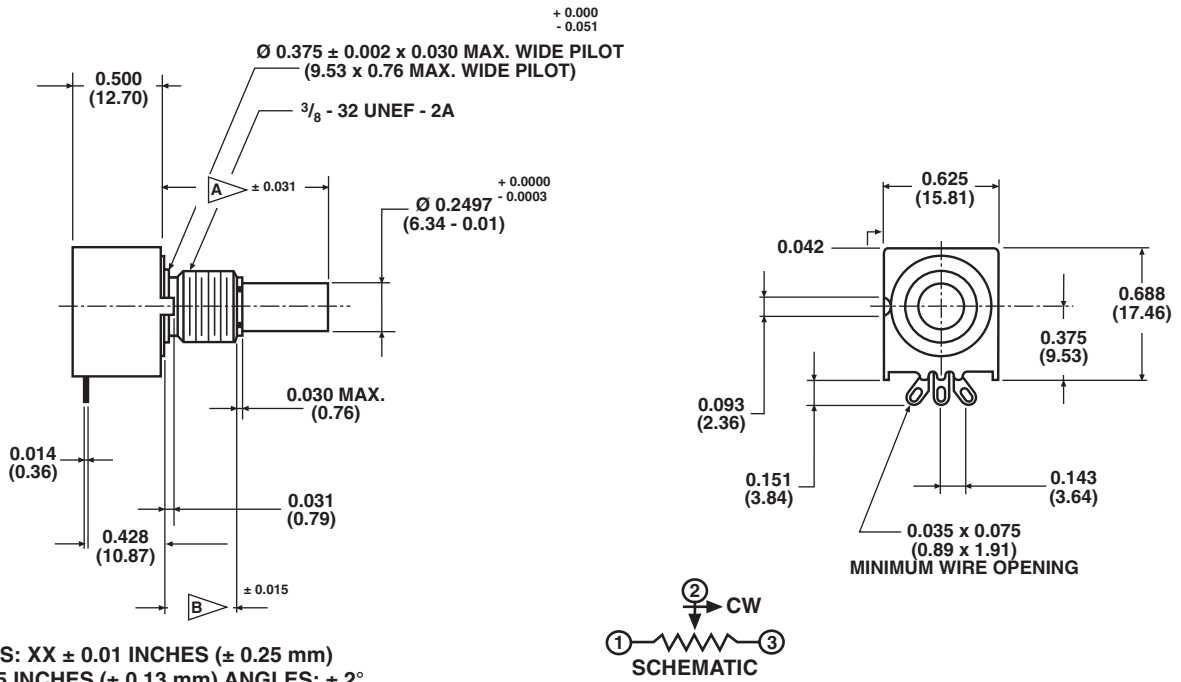

SHAFT FLAT AND PHASING DIAGRAM

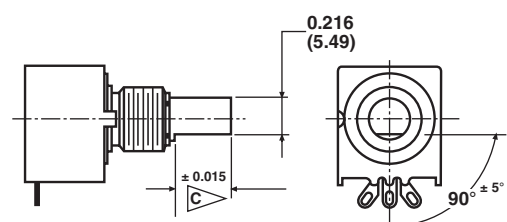

WITH SHAFT FLAT POSITIONED AS SHOWN, OUTPUT RATIO TO BE e/E = 0.50 ± 0.02

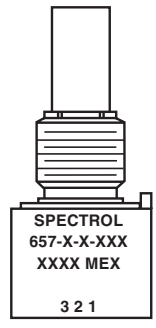

STANDARD RESISTANCE VALUES	
CODE	RESISTANCE (Ω)
102	1K
202	2K
502	5K
103	10K
203	20K
503	50K
104	100K

ENVIRONMENTAL SPECIFICATIONS	
Rotational Life	2 million revolutions
Vibration	15 G's at 10 to 2000 Hz
Operating Temperature	- 40 °C to + 125 °C
Storage Temperature	- 55 °C to + 150 °C
Temperature Coefficient	± 600 ppm/°C
Shock	30 G's
Resistant to Solder Heat	350 °C for 5 s
Moisture Resistance IP Rating	Sealed construction IP67* application to provide protection for wiring terminals

MATERIAL SPECIFICATIONS	
Shaft	Stainless steel
Bushing	Nickel plated brass
Housing	Thermoplastic
Element	Conductive plastic on alumina substrate

MARKING	
Unit Identification	Vishay Spectrol, part number, data code, country of origin and terminal designation



Disclaimer

ALL PRODUCT, PRODUCT SPECIFICATIONS AND DATA ARE SUBJECT TO CHANGE WITHOUT NOTICE TO IMPROVE RELIABILITY, FUNCTION OR DESIGN OR OTHERWISE.

Vishay Intertechnology, Inc., its affiliates, agents, and employees, and all persons acting on its or their behalf (collectively, "Vishay"), disclaim any and all liability for any errors, inaccuracies or incompleteness contained in any datasheet or in any other disclosure relating to any product.

Vishay makes no warranty, representation or guarantee regarding the suitability of the products for any particular purpose or the continuing production of any product. To the maximum extent permitted by applicable law, Vishay disclaims (i) any and all liability arising out of the application or use of any product, (ii) any and all liability, including without limitation special, consequential or incidental damages, and (iii) any and all implied warranties, including warranties of fitness for particular purpose, non-infringement and merchantability.

Statements regarding the suitability of products for certain types of applications are based on Vishay's knowledge of typical requirements that are often placed on Vishay products in generic applications. Such statements are not binding statements about the suitability of products for a particular application. It is the customer's responsibility to validate that a particular product with the properties described in the product specification is suitable for use in a particular application. Parameters provided in datasheets and/or specifications may vary in different applications and performance may vary over time. All operating parameters, including typical parameters, must be validated for each customer application by the customer's technical experts. Product specifications do not expand or otherwise modify Vishay's terms and conditions of purchase, including but not limited to the warranty expressed therein.

Except as expressly indicated in writing, Vishay products are not designed for use in medical, life-saving, or life-sustaining applications or for any other application in which the failure of the Vishay product could result in personal injury or death. Customers using or selling Vishay products not expressly indicated for use in such applications do so at their own risk and agree to fully indemnify and hold Vishay and its distributors harmless from and against any and all claims, liabilities, expenses and damages arising or resulting in connection with such use or sale, including attorneys fees, even if such claim alleges that Vishay or its distributor was negligent regarding the design or manufacture of the part. Please contact authorized Vishay personnel to obtain written terms and conditions regarding products designed for such applications.

No license, express or implied, by estoppel or otherwise, to any intellectual property rights is granted by this document or by any conduct of Vishay. Product names and markings noted herein may be trademarks of their respective owners.

X-ON Electronics

Largest Supplier of Electrical and Electronic Components

Click to view similar products for [Industrial Motion & Position Sensors](#) category:

Click to view products by [Vishay](#) manufacturer:

Other Similar products are found below :

[595002M9474](#) [01071901](#) [D02318603](#) [70U1N048S104U](#) [FE-41164](#) [G8652](#) [G8744](#) [GA1T040F103UA](#) [GA1T100F502UA-A](#)
[GA2E056P102UA](#) [GA2G140F252UA-A](#) [GA2T044S103UA-B](#) [GPS8627](#) [GS2T032F253BA](#) [GS4P048F503UC](#) [GS4T040F503UC](#) [GS8367B](#)
[GS8819](#) [9811405](#) [RDC1010A12](#) [JA3G032P501UA-A](#) [KJ5-M18MB60-AZS](#) [27M226](#) [9810825](#) [9870706](#) [F07008036](#) [SPSN048P202U](#)
[F65118112](#) [GA2G042F103UA](#) [GA2M028S102MC](#) [GA2M028S502RA](#) [GA2T056F502UA](#) [GH8810](#) [25M921](#) [GS8368B](#) [CM47070](#)
[CR121250](#) [31M573](#) [380000M8643](#) [385500M9303](#) [388037M6962](#) [388281M9646](#) [388517025480039](#) [388580038670069](#) [388818078120022](#)
[388860073800031](#) [388C11M9548](#) [388C24160090003](#) [389504075810001](#) [389767001230861](#)