

## Accessories

### DE SHAFT AND PANEL SEALING HARDWARE

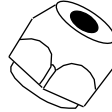

TYPE	LENGTH	WRENCH	Ø SHAFT	ORDERING INFORMATION	PACKAGING
Ø M6 x 0.75	9	12	3	ACCPOTDEB173351950	25

### DBAN SHAFT LOCKING

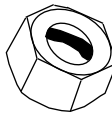

TYPE	LENGTH	WRENCH	Ø SHAFT	ORDERING INFORMATION	PACKAGING
Ø M10 x 0.75	6.5	12	6	ACCPOTDBB173190100	25

### LOCATING PEG

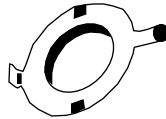

PRODUCT	THICKNESS	ORDERING INFORMATION	PACKAGING
PE30	0.8	ACCPOTLPB153804132	20

### LOCATING PEG

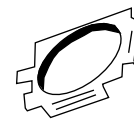

PRODUCT	THICKNESS	L FROM CENTER	ORDERING INFORMATION	PACKAGING
P11-149	0.4	6.2 mm (0.244")	ACCPOTERB253651650	50
P11-149	0.4	7.75 mm (0.305")	ACCPOTERB253656660	50
P11-149	0.8	13.5 mm (0.53")	ACCPOTERB253653190	50

### BASE RAISER

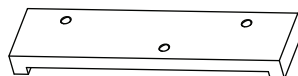

PRODUCT	HEIGHT	ORDERING INFORMATION	PACKAGING
M43 T18	1.6	ACCTRICAB253850610	50

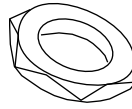
**NUTS**

THICKNESS	WRENCH	BUSHING	ORDERING INFORMATION	PACKAGING
Nut H 10 ep. 2.5	14	M10 x 0.75	ACCPOTECB303404310	100
Nut H 7 ep. 2	10	M7 x 0.75	ACCPOTECB303351680	100
Nut H 6 ep. 1.8	10	M6 x 0.75	ACCPOTECB302005700	100
Nut H 6 ep. 1.8	8	M6 x 0.75	ACCPOTECB303651550	100
Nut H 8 ep. 2	12	M8 x 0.75	ACCPOTECB303652600	100
Nut H 10 ep. 2	12	M10 x 0.75	ACCPOTECB303653200	100
Nut H 3/8" ep. 2.5	12.5/1/2"	3/8 32 NEF-2A	ACCPOTECB303653230	100
Nut H 1/4" ep. 2	8	1/4 32 NEF-2A	ACCPOTECB303430230	100

**WASHER**

DIAMETER	BUSHING	ORDERING INFORMATION	PACKAGING
Internal washer JZ Ø 10 or 3/8"	M10 x 0.75	ACCPOTRDB300685710	100
Internal washer JZ Ø 7	M7 x 0.75	ACCPOTRDB300683707	100
Internal washer JZ Ø 6	M6 x 0.75	ACCPOTRDB300683706	100
External washer JZ Ø 1/4"	1/4 32 NEF-2A	ACCPOTRDB003430600	100
Internal washer 3/8"	3/8 32 NEF-2A	ACCPOTRDB300683952	100

**O RING**

TYPE	PRODUCT	DIMENSIONS	ORDERING INFORMATION	PACKAGING
Panel O ring toric	PRV6	Ø int 8 mm/Ø tore 1 mm	ACCPOTJOB303342420	100
Panel O ring plate	P16	Ø ext 13.2 mm/Ø int 9.7 mm/Ep 0.8 mm	ACCPOTJOB303753950	100
Panel O ring plate	P11P	Ø ext 12.5 mm/Ø int 9.5 mm/Ep 1.2 mm	ACCPOTJOB303652780	100

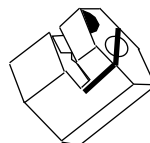
**HEXAGONAL LOCKING NUT**

TYPE	LENGTH	WRENCH	Ø SHAFT	ORDERING INFORMATION	PACKAGING
Hex nut M6 x 0.75	10	10	3	ACCPOTECB253651420	50

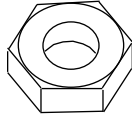

LOCKING NUT FOR SLOTTED BUSHING					
					
TYPE	WRENCH	SHAFT DIAMETER	PRODUCT	ORDERING INFORMATION	PACKAGING
Locking nut Ø 6.35 mm	8	3.17 mm	P11 - PRV6/D or E	ACCPOTECB303656590	100
Locking nut Ø 6 mm	8	3 mm	P13/O	ACCPOTECB303430400	100

GLOBAL PART NUMBER INFORMATION																	
A	C	C	P	O	T	E	C	B	3	0	3	4	0	4	3	1	0
MODEL				STYLE				PACKAGING CODE				SPECIAL NUMBER					
<b>ACCPOT</b> = For potentiometers <b>ACCTRI</b> = For trimmers				<b>EC</b> = Nut <b>ER</b> = Peg <b>CA</b> = Spacer <b>LP</b> = LPRP <b>DB</b> = DBAN <b>JO</b> = Ring <b>DE</b> = Sealing system				<b>B15</b> = Box of 20 pieces <b>B17</b> = Box of 25 pieces <b>B25</b> = Box of 50 pieces <b>B30</b> = Box of 100 pieces				Given by Vishay					

PART NUMBER DESCRIPTION (for information only)				
AC	ECR0UH10	POT	3404310	e
MODEL	STYLE	SPECIAL	SPECIAL	LEAD (Pb)-FREE

## X-ON Electronics

Largest Supplier of Electrical and Electronic Components

*Click to view similar products for [Potentiometer Tools & Fixings](#) category:*

*Click to view products by [Vishay](#) manufacturer:*

Other Similar products are found below :

[7071](#) [7071E](#) [7072E](#) [FKS-1/4](#) [H-38-3](#) [1220A](#) [ACCPOTDBB173190100](#) [H-858](#) [H-137-000](#) [H-37-5](#) [H-38-1](#) [7090E](#) [7074E](#) [RK14K1240A4S](#)  
[HARDWARE](#) [H-862](#) [100P8](#) [H-80-1](#) [RKZ00020NA](#) [34-1032-1A](#) [006-1-0](#) [1-150](#) [T4845 09](#) [T4845 26](#) [H-38-2](#) [H-37-1](#) [DA-01](#) [P0700-21](#)  
[P0700-7](#) [DA-02](#) [008T000](#) [T4845 13](#) [T4845 18](#) [T4857](#) [GSD-675](#) [H-114P](#) [H-83P](#) [H-90](#) [H-91](#) [DA-83](#) [6533E](#) [6591E](#) [7070E](#) [7091E](#) [5465](#)  
[RKZ00023UA](#) [ZB4BD912](#) [T4844](#) [T4847](#) [T4847 0](#) [T4856](#)