

DC Film Capacitors MKT Radial Potted Type

FEATURES

- 15 mm to 27.5 mm lead pitch.
Supplied loose in box and taped on reel
- Material categorization:
for definitions of compliance please see
www.vishay.com/doc?99912



RoHS
COMPLIANT
HALOGEN
FREE

APPLICATIONS

Blocking and coupling, bypass and energy reservoir

| QUICK REFERENCE DATA | |
|---|---|
| Capacitance tolerance | $\pm 10\%$, $\pm 5\%$ |
| Capacitance range (E12 series) | 0.047 μF to 15 μF |
| Rated DC voltage | 100 V, 250 V, 400 V, 630 V |
| Rated AC voltage | 63 V, 160 V, 220 V, 250 V |
| Climatic testing class (according to IEC 60068-1) | 55/105/56 |
| Rated temperature | 85 °C |
| Maximum application temperature | 105 °C |
| Performance grade | Grade 1 (long life) |
| Leads | Tinned wire |
| Reference standards | IEC 60384-2 |
| Dielectric | Polyester film |
| Electrodes | Metallized |
| Construction | Mono construction  |
| Encapsulation | Flame retardant plastic case and epoxy resin (UL-class 94 V-0) |
| Marking | C-value; tolerance; rated voltage; manufacturer's symbol; year and week of manufacturer; manufacturer's type |

Note

- For more detailed data and test requirements, contact dc-film@vishay.com

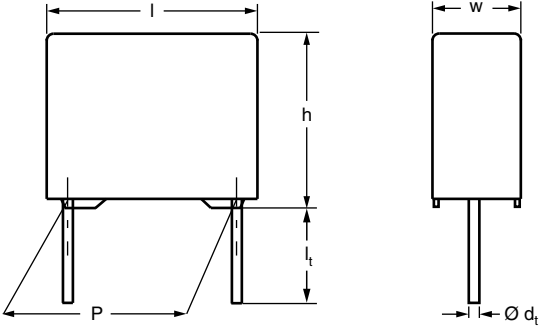
| DIMENSIONS |
|--|
|  |

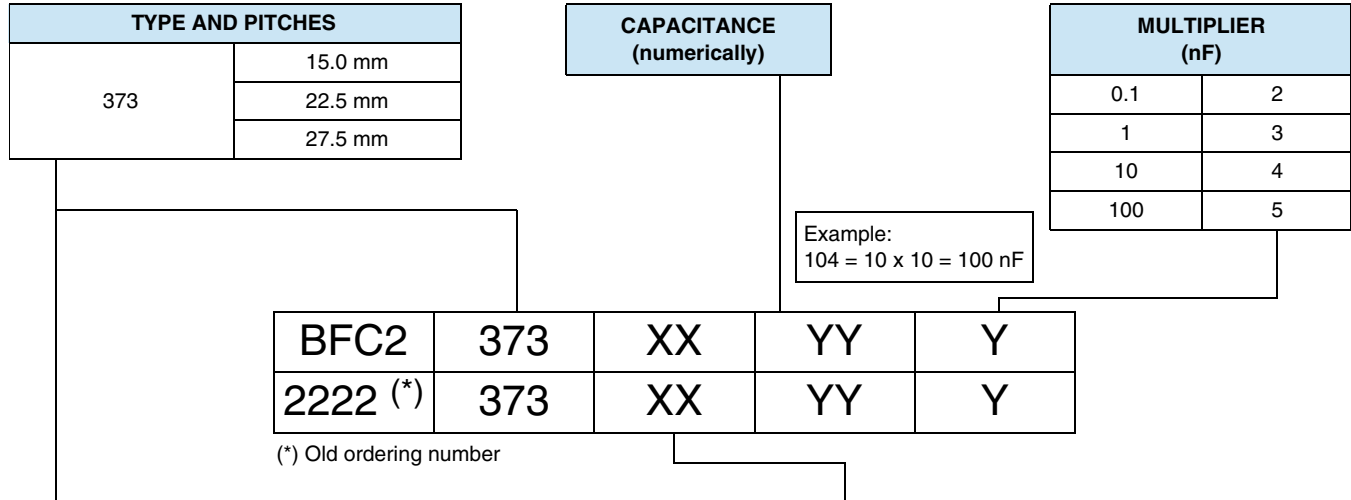
COMPOSITION OF CATALOG NUMBER

| TYPE | PACKAGING | LEAD CONFIGURATION | PREFERRED TYPES | | | | |
|-----------------|-------------------|--|-----------------|-------|-------|-------|-------|
| | | | C-TOL. | 100 V | 250 V | 400 V | 630 V |
| 373 compact | Loose in box | Lead length 5.0 mm ± 1.0 mm | ± 10 % | 23 | 43 | 53 | 63 |
| | Taped on reel (1) | H ⁽¹⁾ = 18.5 mm P ₀ = 12.7 mm Reel diameter = 356 mm | ± 5 % | 24 | 44 | 54 | 64 |
| | | | ± 10 % | 27 | 47 | 57 | 67 |
| 373 standard | Loose in box | Lead length 5.0 mm ± 1.0 mm | ± 10 % | 21 | 41 | 51 | - |
| | | | ± 5 % | 22 | 42 | 52 | |
| | Taped on reel (1) | H ⁽¹⁾ = 18.5 mm P ₀ = 12.7 mm Reel diameter = 356 mm | ± 10 % | 25 | 45 | 55 | |
| | | | ± 5 % | 26 | 46 | 56 | |

Note

(1) For detailed tape specifications refer to packaging information: www.vishay.com/doc?28139

| SPECIFIC REFERENCE DATA | | | | |
|--|-------------------------|--------------------------|--------------------------|---------------------|
| DESCRIPTION | VALUE | | | |
| | at 1 kHz | at 10 kHz | at 100 kHz | |
| Tangent of loss angle: | | | | |
| C ≤ 0.1 μF | ≤ 75 x 10 ⁻⁴ | ≤ 130 x 10 ⁻⁴ | ≤ 250 x 10 ⁻⁴ | |
| 0.1 μF < C ≤ 0.47 μF | ≤ 75 x 10 ⁻⁴ | ≤ 130 x 10 ⁻⁴ | ≤ 300 x 10 ⁻⁴ | |
| 0.47 μF < C ≤ 1.0 μF | ≤ 75 x 10 ⁻⁴ | ≤ 130 x 10 ⁻⁴ | - | |
| 1.0 μF < C ≤ 10 μF | ≤ 75 x 10 ⁻⁴ | ≤ 150 x 10 ⁻⁴ | - | |
| C > 10 μF | ≤ 75 x 10 ⁻⁴ | - | - | |
| Rated voltage pulse slope (dU/dt) _R at | 100 V _{DC} | 250 V _{DC} | 400 V _{DC} | 630 V _{DC} |
| P = 15 mm | 14 V/μs | 16 V/μs | 34 V/μs | 90 V/μs |
| P = 22.5 mm | 5 V/μs | 7 V/μs | 14 V/μs | 35 V/μs |
| P = 27.5 mm | 4 V/μs | 6 V/μs | 12 V/μs | 30 V/μs |
| R between leads, for C ≤ 0.33 μF at 100 V; 1 min at 500 V; 1 min | > 15 000 MΩ | > 15 000 MΩ | > 30 000 MΩ | > 30 000 MΩ |
| RC between leads, for C > 0.33 μF at 100 V; 1 min at 500 V; 1 min | > 5000 s | > 10 000 s | > 10 000 s | > 10 000 s |
| R between interconnecting leads and case (foil method) | > 30 000 MΩ | | | |
| Withstanding (DC) voltage (cut off current 10 mA) ⁽¹⁾ ; rise time ≤ 1000 V/s | 160 V; 1 min | 400 V; 1 min | 640 V; 1 min | 1008 V; 1 min |
| Withstanding (DC) voltage between leads and case | 200 V; 1 min | 500 V; 1 min | 800 V; 1 min | 1260 V; 1 min |
| Maximum application temperature | 105 °C | | | |

Note

(1) See "Voltage Proof Test for Metallized Film Capacitors": www.vishay.com/doc?28169



| ELECTRICAL DATA - COMPACT SIZE | | | | | | | | | |
|--|--|---------------------------------|----------------------------|---|-----------------|---------------------------------------|-----------------|----------------------|-----|
| U _{RDC} (V) | CAP. (μF) | DIMENSIONS w x h x l (mm) | MASS (g) ⁽³⁾ | CATALOG NUMBER BFC2 373 XYYYY AND PACKAGING | | | | C-VALUE ..YYY | |
| | | | | LOOSE IN BOX | | REEL ⁽¹⁾⁽²⁾ | | | |
| | | | | l _t = 5.0 mm ± 1.0 mm | | H = 18.5 mm; P ₀ = 12.7 mm | | | |
| | | | | C-TOL. = ± 10 % | C-TOL. = ± 5 % | C-TOL. = ± 10 % | C-TOL. = ± 5 % | | |
| | | | | XX (SPQ) | XX (SPQ) | XX (SPQ) | XX (SPQ) | | |
| U_{RAC} = 63 V; PITCH = 15.0 mm ± 0.4 mm; d_t = 0.60 mm ± 0.06 mm | | | | | | | | | |
| 100 | 0.33 | 5.0 x 11.0 x 17.5 | 1.1 | 23... (1000) | 24... (1000) | 27... (1100) | 28... (1100) | 334 | |
| | 0.39 | | | | | | | 394 | |
| | 0.47 | | | | | | | 474 | |
| | 0.56 | | | | | | | 564 | |
| | 0.68 | | | | | | | 684 | |
| | 0.82 | | | | | | | 824 | |
| | 1.0 | | | | | | | 105 | |
| | 1.2 | | | | | | | 125 | |
| | 1.5 | | | | | | | 155 | |
| | 1.8 | 185 | | | | | | | |
| 2.2 | 6.0 x 12.0 x 17.5 | 1.5 | 23... (1000) | 24... (1000) | 27... (900) | 28... (900) | 225 | | |
| U_{RAC} = 63 V; PITCH = 15.0 mm ± 0.4 mm; d_t = 0.80 mm ± 0.08 mm | | | | | | | | | |
| 2.7 | 7.0 x 13.5 x 17.5 | 2.0 | 23... (1000) | 24... (1000) | 27... (800) | 28... (800) | 275 | | |
| 3.3 | | | | | | | | 335 | |
| 3.9 | 8.5 x 15.0 x 17.5 | 2.7 | 23... (1000) | 24... (1000) | 27... (650) | 28... (650) | 395 | | |
| 4.7 | | | | | | | | 475 | |
| U_{RAC} = 160 V; PITCH = 15.0 mm ± 0.40 mm; d_t = 0.60 mm ± 0.06 mm | | | | | | | | | |
| 250 | 0.15 | 5.0 x 11.0 x 17.5 | 1.1 | 43... (1000) | 44... (1000) | 47... (1100) | 48... (1100) | 154 | |
| | 0.18 | | | | | | | 184 | |
| | 0.22 | | | | | | | 224 | |
| | 0.27 | | | | | | | 274 | |
| | 0.32 | | | | | | | 334 | |
| | 0.39 | 6.0 x 12.0 x 17.5 | 1.5 | 43... (1000) | 44... (1000) | 47... (900) | 48... (900) | 394 | |
| | 0.47 | | | | | | | 474 | |
| | U_{RAC} = 160 V; PITCH = 15.0 mm ± 0.40 mm; d_t = 0.80 mm ± 0.08 mm | | | | | | | | |
| | 0.56 | 7.0 x 13.5 x 17.5 | 2.0 | 43... (1000) | 44... (1000) | 47... (800) | 48... (800) | 564 | |
| | 0.68 | | | | | | | | 684 |
| | 0.82 | 8.5 x 15.0 x 17.5 | 2.7 | 43... (1000) | 44... (1000) | 47... (650) | 48... (650) | 824 | |
| | 1.0 | | | | | | | | 105 |
| | 1.2 | 10.0 x 16.5 x 17.5 | 3.5 | 43... (500) | 44... (500) | 47... (600) | 48... (600) | 125 | |
| | U_{RAC} = 160 V; PITCH = 22.5 mm ± 0.4 mm; d_t = 0.80 mm ± 0.08 mm | | | | | | | | |
| | 1.5 | 8.5 x 18.0 x 26.0 | 4.5 | 43... (200) | 44... (200) | 47... (450) | 48... (450) | 155 | |
| | 1.8 | | | | | | | | 185 |
| 2.2 | 10.0 x 19.5 x 26.0 | 5.7 | 43... (200) | 44... (200) | 47... (350) | 48... (350) | 225 | | |
| 2.7 | | | | | | | | 275 | |
| U_{RAC} = 160 V; PITCH = 27.5 mm ± 0.4 mm; d_t = 0.80 mm ± 0.08 mm | | | | | | | | | |
| 3.3 | 11.0 x 21.0 x 31.0 | 8.2 | 43... (100) | 44... (100) | - | - | 335 | | |
| 3.9 | 13.0 x 23.0 x 31.0 | 10.2 | 43... (100) | 44... (100) | - | - | 395 | | |
| 4.7 | | | | | | | | 475 | |



| ELECTRICAL DATA - COMPACT SIZE | | | | | | | | | |
|---|---|---------------------------------|----------------------------|--|-----------------|---------------------------------------|-----------------|---|------------|
| U _{RDC} (V) | CAP. (µF) | DIMENSIONS w x h x l (mm) | MASS (g) ⁽³⁾ | CATALOG NUMBER BFC2 373 XXYY AND PACKAGING | | | | C-VALUE ..YYY | |
| | | | | LOOSE IN BOX | | REEL ⁽¹⁾⁽²⁾ | | | |
| | | | | l _t = 5.0 mm ± 1.0 mm | | H = 18.5 mm; P ₀ = 12.7 mm | | | |
| | | | | C-TOL. = ± 10 % | C-TOL. = ± 5 % | C-TOL. = ± 10 % | C-TOL. = ± 5 % | | |
| | | | | XX (SPQ) | XX (SPQ) | XX (SPQ) | XX (SPQ) | | |
| U_{RAC} = 220 V; PITCH = 15.0 mm ± 0.4 mm; d_t = 0.60 mm ± 0.06 mm | | | | | | | | | |
| 400 | 0.047 0.056 0.068 0.082 0.10 0.12 0.15 | 5.0 x 11.0 x 17.5 | 1.1 | 53... (1000) | 54... (1000) | 57... (1100) | 58... (1100) | 473 563 683 823 104 124 154 | |
| | 0.18 0.22 | 6.0 x 12.0 x 17.5 | 1.5 | 53... (1000) | 54... (1000) | 57... (900) | 58... (900) | 184 224 | |
| | U_{RAC} = 220 V; PITCH = 15.0 mm ± 0.4 mm; d_t = 0.80 mm ± 0.08 mm | | | | | | | | |
| | 0.27 0.33 | 7.0 x 13.5 x 17.5 | 2.0 | 53... (1000) | 54... (1000) | 57... (800) | 58... (800) | 274 334 | |
| | 0.39 0.47 | 8.5 x 15.0 x 17.5 | 2.7 | 53... (1000) | 54... (1000) | 57... (650) | 58... (650) | 394 474 | |
| | 0.56 | 10.0 x 16.5 x 17.5 | 3.5 | 53... (500) | 54... (500) | 57... (600) | 58... (600) | 564 | |
| | U_{RAC} = 220 V; PITCH = 22.5 mm ± 0.4 mm; d_t = 0.80 mm ± 0.08 mm | | | | | | | | |
| | 0.68 0.82 | 8.5 x 18.0 x 26.0 | 4.5 | 53... (200) | 54... (200) | 57... (450) | 58... (450) | 684 824 | |
| | 1.0 1.2 | 10.0 x 19.5 x 26.0 | 5.7 | 53... (200) | 54... (200) | 57... (350) | 58... (350) | 105 125 | |
| | U_{RAC} = 220 V; PITCH = 27.5 mm ± 0.4 mm; d_t = 0.80 mm ± 0.08 mm | | | | | | | | |
| | 1.5 | 11.0 x 21.0 x 31.0 | 8.2 | 53... (100) | 54... (100) | - | - | 155 | |
| | 1.8 2.2 | 13.0 x 23.0 x 31.0 | 10.2 | 53... (100) | 54... (100) | - | - | 185 225 | |
| | U_{RAC} = 250 V; PITCH = 15.0 mm ± 0.4 mm; d_t = 0.60 mm ± 0.06 mm | | | | | | | | |
| | 630 | 0.047 0.056 | 5.0 x 11.0 x 17.5 | 1.1 | 63... (1000) | 64... (1000) | 67... (1100) | 68... (1100) | 473 563 |
| 0.068 0.082 | | 6.0 x 12.0 x 17.5 | 1.5 | 63... (1000) | 64... (1000) | 67... (900) | 68... (900) | 683 823 | |
| U_{RAC} = 250 V; PITCH = 15.0 mm ± 0.4 mm; d_t = 0.80 mm ± 0.08 mm | | | | | | | | | |
| 0.10 0.12 | | 7.0 x 13.5 x 17.5 | 2.0 | 63... (1000) | 64... (1000) | 67... (800) | 68... (800) | 104 124 | |
| 0.15 0.18 | | 8.5 x 15.0 x 17.5 | 2.7 | 63... (1000) | 64... (1000) | 67... (650) | 68... (650) | 154 184 | |
| 0.22 | | 10.0 x 16.5 x 17.5 | 3.5 | 63... (500) | 64... (500) | 67... (600) | 68... (600) | 224 | |
| U_{RAC} = 250 V; PITCH = 22.5 mm ± 0.4 mm; d_t = 0.80 mm ± 0.08 mm | | | | | | | | | |
| 0.27 0.33 | | 8.5 x 18.0 x 26.0 | 4.5 | 63... (200) | 64... (200) | 67... (450) | 68... (450) | 274 334 | |
| 0.39 0.47 | | 10.0 x 19.5 x 26.0 | 5.7 | 63... (200) | 64... (200) | 67... (350) | 68... (350) | 394 474 | |
| U_{RAC} = 250 V; PITCH = 27.5 mm ± 0.4 mm; d_t = 0.80 mm ± 0.08 mm | | | | | | | | | |
| 0.56 | | 11.0 x 21.0 x 31.0 | 8.2 | 63... (100) | 64... (100) | - | - | 564 | |
| 0.68 0.82 | | 13.0 x 23.0 x 31.0 | 10.2 | 63... (100) | 64... (100) | - | - | 684 824 | |
| 1.00 | | 15.0 x 25.0 x 31.5 | 13.4 | 63... (100) | 64... (100) | - | - | 105 | |

Notes

• SPQ = Standard Packing Quantity

(1) Reel diameter = 356 mm is available on request

(2) H = in-tape height; P₀ = sprocket hole distance; for detailed specifications refer to packaging information: www.vishay.com/doc?28139

(3) Weight for short lead product only



| ELECTRICAL DATA - STANDARD SIZE | | | | | | | | | | | |
|---|---|---------------------------------|----------------------------|---|-----------------|---------------------------------------|-----------------|---------------------------------|-----------------|--------------------------|----------------|
| U _{RDC} (V) | C (μF) | DIMENSIONS w x h x l (mm) | MASS (g) ⁽³⁾ | CATALOG NUMBER BFC2 373 XYYYY AND PACKAGING | | | | C-VALUE ..YYY | | | |
| | | | | LOOSE IN BOX | | REEL ⁽¹⁾⁽²⁾ | | | | | |
| | | | | l _t = 5.0 mm ± 1.0 mm | | H = 18.5 mm; P ₀ = 12.7 mm | | | | | |
| | | | | C-TOL. = ± 10 % | C-TOL. = ± 5 % | C-TOL. = ± 10 % | C-TOL. = ± 5 % | | | | |
| | | | | XX (SPQ) | XX (SPQ) | XX (SPQ) | XX (SPQ) | | | | |
| U_{RAC} = 63 V; PITCH = 15.0 mm ± 0.4 mm; d_t = 0.60 mm ± 0.06 mm | | | | | | | | | | | |
| 100 | 0.33 0.39 0.47 0.56 0.68 | 5.0 x 11.0 x 17.5 | 1.1 | 21... (1000) | 22... (1000) | 25... (1100) | 26... (1100) | 334 394 474 564 684 | | | |
| | 0.82 1.00 | | | 6.0 x 12.0 x 17.5 | 1.5 | 21... (1000) | 22... (1000) | 25... (900) | 26... (900) | 824 105 | |
| | U_{RAC} = 63 V; PITCH = 15.0 mm ± 0.4 mm; d_t = 0.80 mm ± 0.08 mm | | | | | | | | | | |
| | 1.2 1.5 | | | 7.0 x 13.5 x 17.5 | 2.0 | 21... (1000) | 22... (1000) | 25... (800) | 26... (800) | 125 155 | |
| | 1.8 2.2 | | | | | 8.5 x 15.0 x 17.5 | 2.7 | 21... (1000) | 22... (1000) | 25... (650) | 26... (650) |
| | U_{RAC} = 63 V; PITCH = 22.5 mm ± 0.4 mm; d_t = 0.80 mm ± 0.08 mm | | | | | | | | | | |
| | 2.7 3.3 | 8.5 x 18.0 x 26.0 | 4.5 | 21... (200) | 22... (200) | 25... (450) | 26... (450) | 275 335 | | | |
| | 3.9 4.7 | | | 10.0 x 19.5 x 26.0 | 5.7 | 21... (200) | 22... (200) | 25... (350) | 26... (350) | 395 475 | |
| | U_{RAC} = 63 V; PITCH = 27.5 mm ± 0.4 mm; d_t = 0.80 mm ± 0.08 mm | | | | | | | | | | |
| | 5.6 6.8 | 11.0 x 21.0 x 31.0 | 8.2 | 21... (100) | 22... (100) | - | - | 565 685 | | | |
| | 8.2 10 | | | 13.0 x 23.0 x 31.0 | 10.2 | 21... (100) | 22... (100) | - | - | 825 106 | |
| | 12 15 | 18.0 x 28.0 x 31.5 | 18.4 | | | 21... (100) | 22... (100) | - | - | 126 156 | |
| U_{RAC} = 160 V; PITCH = 15.0 mm ± 0.4 mm; d_t = 0.60 mm ± 0.06 mm | | | | | | | | | | | |
| 250 | 0.15 0.18 0.22 | 5.0 x 11.0 x 17.5 | 1.1 | 41... (1000) | 42... (1000) | 45... (1100) | 46... (1100) | 154 184 224 | | | |
| | 0.27 0.33 0.39 0.47 | | | 6.0 x 12.0 x 17.5 | 1.5 | 41... (1000) | 42... (1000) | 45... (900) | 46... (900) | 274 334 394 474 | |
| | U_{RAC} = 160 V; PITCH = 15.0 mm ± 0.4 mm; d_t = 0.80 mm ± 0.08 mm | | | | | | | | | | |
| | 0.56 0.68 | 7.0 x 13.5 x 17.5 | 2.0 | 41... (1000) | 42... (1000) | 45... (800) | 46... (800) | 564 684 | | | |
| | 0.82 1.0 | | | 8.5 x 15.0 x 17.5 | 2.7 | 41... (1000) | 42... (1000) | 45... (650) | 46... (650) | 824 105 | |
| | U_{RAC} = 160 V; PITCH = 22.5 mm ± 0.4 mm; d_t = 0.80 mm ± 0.08 mm | | | | | | | | | | |
| | 1.2 1.5 | 8.5 x 18.0 x 26.0 | 4.5 | 41... (200) | 42... (200) | 45... (450) | 46... (450) | 125 155 | | | |
| | 1.8 2.2 | | | 10.0 x 19.5 x 26.0 | 5.7 | 41... (200) | 42... (200) | 45... (350) | 46... (350) | 185 225 | |
| | U_{RAC} = 160 V; PITCH = 27.5 mm ± 0.4 mm; d_t = 0.80 mm ± 0.08 mm | | | | | | | | | | |
| | 2.7 3.3 | 13.0 x 23.0 x 31.0 | 10.2 | 41... (100) | 42... (100) | - | - | 275 335 | | | |
| | 3.9 4.7 | | | 15.0 x 28.0 x 31.5 | 13.4 | 41... (100) | 42... (100) | - | - | 395 475 | |



| ELECTRICAL DATA - STANDARD SIZE | | | | | | | | | |
|---|---|---------------------------------|----------------------------|--|-----------------|---------------------------------------|--------------------|----------------------|----------------|
| U _{RDC} (V) | C (μF) | DIMENSIONS w x h x l (mm) | MASS (g) ⁽³⁾ | CATALOG NUMBER BFC2 373 XXYY AND PACKAGING | | | | C-VALUE ..YYY | |
| | | | | LOOSE IN BOX | | REEL ⁽¹⁾⁽²⁾ | | | |
| | | | | l _t = 5.0 mm ± 1.0 mm | | H = 18.5 mm; P ₀ = 12.7 mm | | | |
| | | | | C-TOL. = ± 10 % | C-TOL. = ± 5 % | C-TOL. = ± 10 % | C-TOL. = ± 5 % | | |
| | | | | XX (SPQ) | XX (SPQ) | XX (SPQ) | XX (SPQ) | | |
| U_{RAC} = 220 V; PITCH = 15.0 mm ± 0.4 mm; d_t = 0.60 mm ± 0.06 mm | | | | | | | | | |
| 400 | 0.047 | 5.0 x 11.0 x 17.5 | 1.1 | 51... (1000) | 52... (1000) | 55... (1100) | 56... (1100) | 473 | |
| | 0.056 | | | | | | | 563 | |
| | 0.068 | | | | | | | 683 | |
| | 0.082 | | | | | | | 823 | |
| | 0.10 | | | | | | | 104 | |
| | 0.12 | 6.0 x 12.0 x 17.5 | 1.5 | 51... (1000) | 52... (1000) | 55... (900) | 56... (900) | 124 | |
| | 0.15 | | | | | | | 154 | |
| | U_{RAC} = 220 V; PITCH = 15.0 mm ± 0.4 mm; d_t = 0.80 mm ± 0.08 mm | | | | | | | | |
| | 0.18 | 7.0 x 13.5 x 17.5 | 2.0 | 51... (1000) | 52... (1000) | 55... (800) | 56... (800) | 184 | |
| | 0.22 | | | | | | | 224 | |
| | 0.27 | 8.5 x 15.0 x 17.5 | 2.7 | 51... (1000) | 52... (1000) | 55... (650) | 56... (650) | 274 | |
| | 0.33 | | | | | | | 334 | |
| | U_{RAC} = 220 V; PITCH = 22.5 mm ± 0.4 mm; d_t = 0.80 mm ± 0.08 mm | | | | | | | | |
| | 0.39 | 8.5 x 18.0 x 26.0 | 4.5 | 51... (200) | 52... (200) | 55... (450) | 56... (450) | 394 | |
| 0.47 | 474 | | | | | | | | |
| 0.56 | 10.0 x 19.5 x 26.0 | 5.7 | 51... (200) | 52... (200) | 55... (350) | 56... (350) | 564 | | |
| 0.68 | | | | | | | 684 | | |
| U_{RAC} = 220 V; PITCH = 27.5 mm ± 0.4 mm; d_t = 0.80 mm ± 0.08 mm | | | | | | | | | |
| 0.82 | 13.0 x 23.0 x 31.0 | 10.2 | 51... (100) | 52... (100) | - | - | 824 | | |
| 1.0 | | | | | | | 105 | | |
| 1.2 | | | | | | | 15.0 x 25.0 x 31.5 | 13.4 | 51... (100) |
| 1.5 | 125 | | | | | | | | |

Notes

- SPQ = Standard Packing Quantity

(1) Reel diameter = 356 mm is available on request

(2) H = in-tape height; P₀ = sprocket hole distance; for detailed specifications refer to packaging information: www.vishay.com/doc?28139

(3) Weight for short lead product only



| ELECTRICAL DATA - AVAILABLE ON REQUEST | | | | | | | | | | |
|---|---|---------------------------------|----------------------------|---|----------------|-----|------------------------|----------------|-----|--|
| U _{RDC} (V) | C (μF) | DIMENSIONS w x h x l (mm) | MASS (g) ⁽³⁾ | CATALOG NUMBER BFC2 373 XXYYY AND PACKAGING | | | | | | |
| | | | | LOOSE IN BOX | | | REEL ⁽¹⁾⁽²⁾ | | | |
| | | | | l _t = 5.0 mm ± 1.0 mm | | | H = 18.5 mm | | | |
| | | | | C-TOL. = ± 10 % | C-TOL. = ± 5 % | SPQ | C-TOL. = ± 10 % | C-TOL. = ± 5 % | SPQ | |
| U_{RAC} = 63 V; PITCH = 22.5 mm ± 0.4 mm; d_t = 0.80 mm ± 0.08 mm | | | | | | | | | | |
| 100 | 1.5 | 6.0 x 15.5 x 26.0 | 2.7 | 90012 | 90013 | 300 | 90018 | 90019 | 600 | |
| | 1.8 | 7.0 x 16.5 x 26.0 | 3.3 | 90022 | 90023 | 200 | 90028 | 90029 | 550 | |
| | 2.2 | | | 90002 | 90003 | | 90008 | 90009 | | |
| | U_{RAC} = 63 V; PITCH = 27.5 mm ± 0.4 mm; d_t = 0.80 mm ± 0.08 mm | | | | | | | | | |
| 4.7 | 9.0 x 19.0 x 31.0 | 6.1 | 90032 | 90033 | 100 | - | | | | |
| U_{RAC} = 160 V; PITCH = 22.5 mm ± 0.4 mm; d_t = 0.80 mm ± 0.08 mm | | | | | | | | | | |
| 250 | 0.47 | 6.0 x 15.5 x 26.0 | 2.7 | 90042 | 90046 | 300 | 90048 | 90049 | 600 | |
| | 0.56 | | | 90052 | 90053 | | 90058 | 90059 | | |
| | 0.68 | | | 90062 | 90063 | | 90068 | 90069 | | |
| | 0.82 | 7.0 x 16.5 x 26.0 | 3.3 | 90072 | 90073 | 200 | 90078 | 90079 | 550 | |
| | 1.0 | | | 90082 | 90083 | | 90088 | 90089 | | |
| | U_{RAC} = 160 V; PITCH = 27.5 mm ± 0.4 mm; d_t = 0.80 mm ± 0.08 mm | | | | | | | | | |
| | 1.2 | 9.0 x 19.0 x 31.5 | 6.1 | 90172 | 90173 | 100 | - | | | |
| | 1.5 | | | 90092 | 90093 | | | | | |
| 1.8 | 9.0 x 21.0 x 31.0 | 8.2 | 90102 | 90103 | 100 | - | | | | |
| 2.2 | | | 90112 | 90113 | | | | | | |
| U_{RAC} = 220 V; PITCH = 22.5 mm ± 0.4 mm; d_t = 0.80 mm ± 0.08 mm | | | | | | | | | | |
| 400 | 0.22 | 6.0 x 15.5 x 26.0 | 2.7 | 90122 | 90123 | 300 | 90128 | 90129 | 600 | |
| | 0.27 | 7.0 x 16.5 x 26.0 | 3.3 | 90132 | 90133 | 200 | 90138 | 90139 | 550 | |
| | 0.33 | | | 90142 | 90143 | | 90148 | 90149 | | |
| | U_{RAC} = 220 V; PITCH = 27.5 mm ± 0.4 mm; d_t = 0.80 mm ± 0.08 mm | | | | | | | | | |
| 0.68 | 9.0 x 19.0 x 31.5 | 6.1 | 90152 | 90153 | 100 | - | | | | |

Notes

- SPQ = Standard Packing Quantity

(1) Reel diameter = 356 mm is available on request

(2) H = in-tape height; P₀ = sprocket hole distance; for detailed specifications refer to packaging information: www.vishay.com/doc?28139

(3) Weight for short lead product only

MOUNTING

Normal Use

The capacitors are designed for mounting on printed-circuit boards. The capacitors packed in bandoliers are designed for mounting in printed-circuit boards by means of automatic insertion machines.

For detailed tape specifications refer to packaging information: www.vishay.com/doc?28139

Specific Method of Mounting to Withstand Vibration and Shock

In order to withstand vibration and shock tests, it must be ensured that stand-off pips are in good contact with the printed-circuit board:

- For pitches ≤ 15 mm capacitors shall be mechanically fixed by the leads
- For larger pitches the capacitors shall be mounted in the same way and the body clamped

Space Requirements On Printed-Circuit Board

The maximum space for length ($l_{max.}$), width ($w_{max.}$) and height ($h_{max.}$) of film capacitors to take in account on the printed-circuit board is shown in the drawing:

- For products with pitch ≤ 15 mm, $\Delta w = \Delta l = 0.3$ mm and $\Delta h = 0.1$ mm
- For products with 15 mm $<$ pitch ≤ 27.5 mm, $\Delta w = \Delta l = 0.5$ mm and $\Delta h = 0.1$ mm

Eccentricity defined as in drawing. The maximum eccentricity is smaller than or equal to the lead diameter of the product concerned.



SOLDERING

For general soldering conditions and wave soldering profile, we refer to the application note:

“Soldering Guidelines for Film Capacitors”: www.vishay.com/doc?28171

Storage Temperature

$T_{stg} = -25$ °C to $+35$ °C with RH maximum 75 % without condensation

Ratings and Characteristics Reference Conditions

Unless otherwise specified, all electrical values apply to an ambient free air temperature of 23 °C ± 1 °C, an atmospheric pressure of 86 kPa to 106 kPa and a relative humidity of 50 % ± 2 %.

For reference testing, a conditioning period shall be applied over 96 h ± 4 h by heating the products in a circulating air oven at the rated temperature and a relative humidity not exceeding 20 %.



CHARACTERISTICS

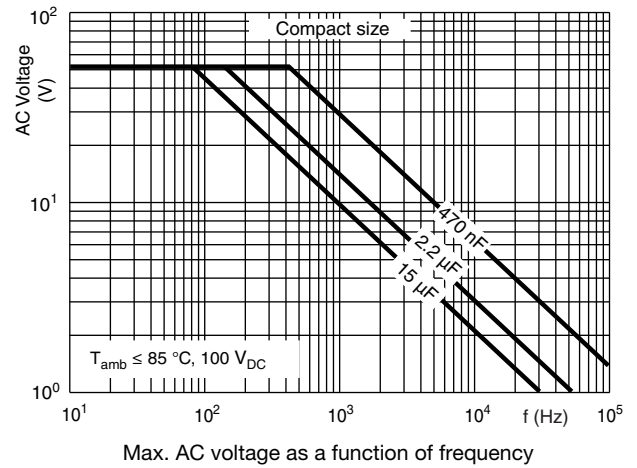
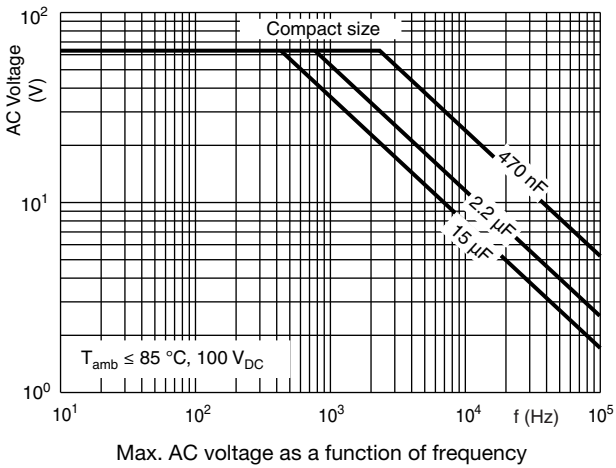
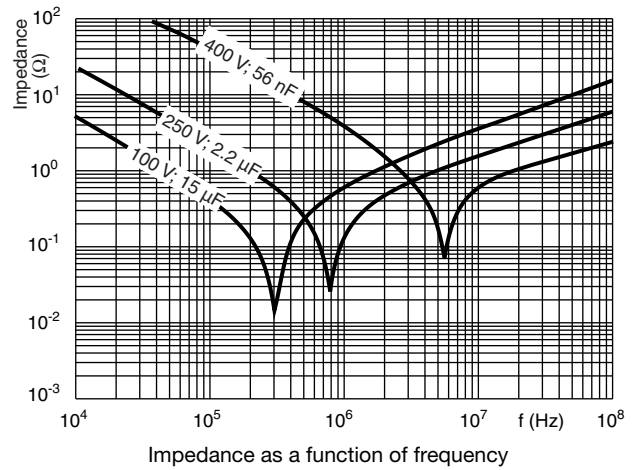
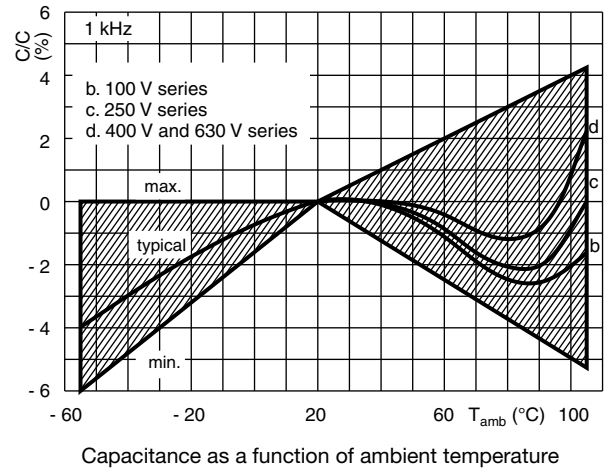
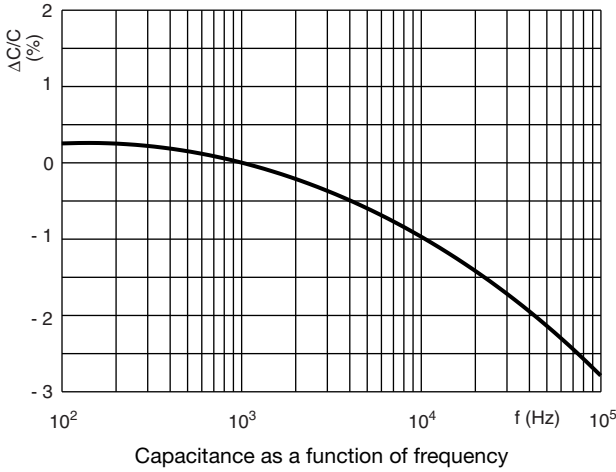

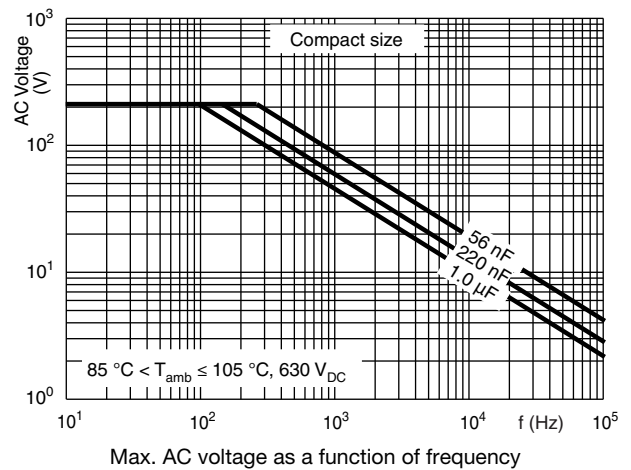
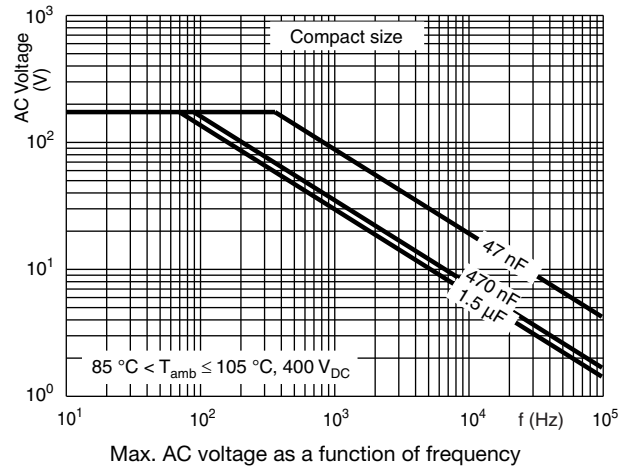
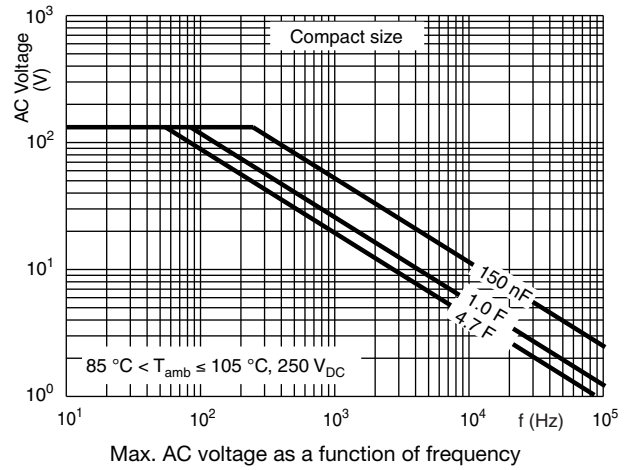

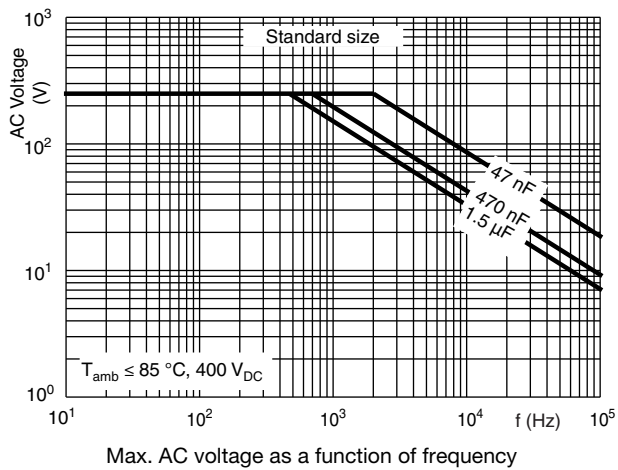
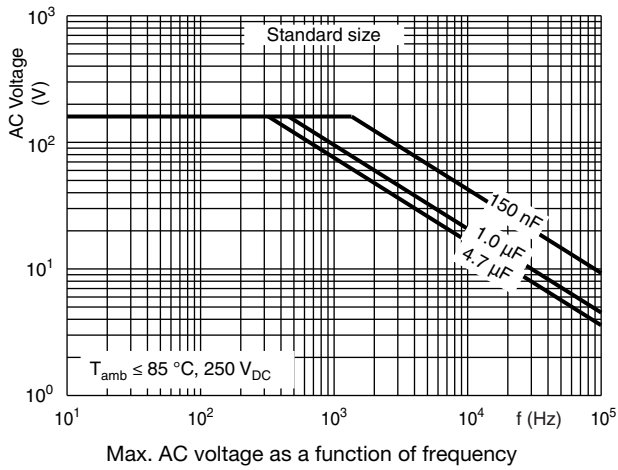
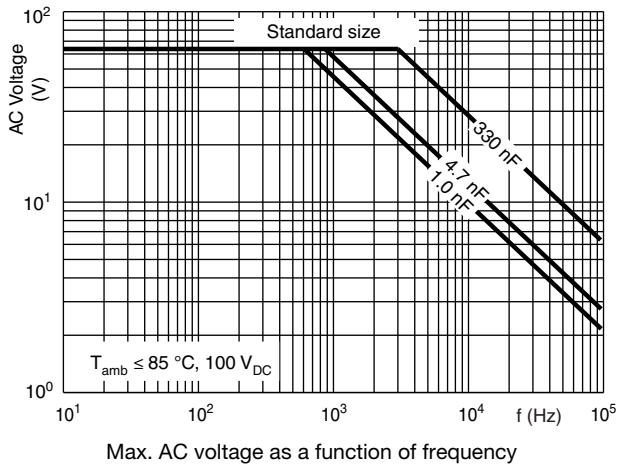



Maximum RMS current (sinewave) as a function of frequency

U_{AC} is the maximum AC voltage depending on the ambient temperature in the curves “Max. RMS voltage and AC current as a function of frequency”.

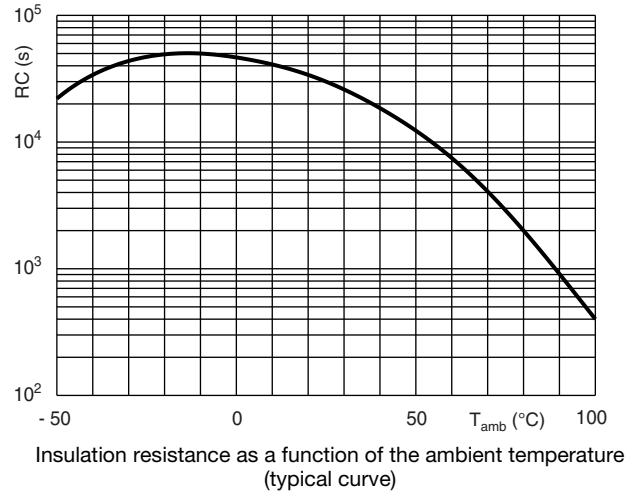
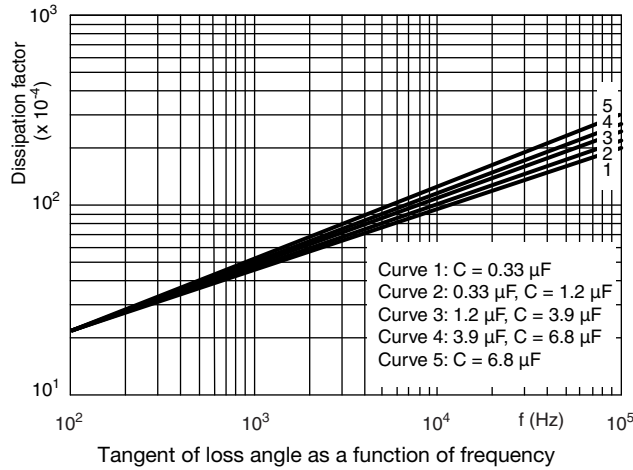

| HEAT CONDUCTIVITY (G) AS A FUNCTION OF (ORIGINAL) PITCH AND CAPACITOR BODY THICKNESS IN mW/°C | | | |
|--|----------------------------------|----------------------|----------------------|
| $W_{MAX.}$ (mm) | HEAT CONDUCTIVITY (mW/°C) | | |
| | PITCH 15.0 mm | PITCH 22.5 mm | PITCH 27.5 mm |
| 5.0 | 10 | - | - |
| 6.0 | 11 | 19 | - |
| 7.0 | 12 | 21 | - |
| 8.5 | 16 | 25 | - |
| 10.0 | 18 | 28 | - |
| 11.0 | - | - | 36 |
| 13.0 | - | - | 42 |
| 15.0 | - | - | 48 |
| 18.0 | - | - | 57 |

POWER DISSIPATION AND MAXIMUM COMPONENT TEMPERATURE RISE

The power dissipation must be limited in order not to exceed the maximum allowed component temperature rise as a function of the free ambient temperature.

The power dissipation can be calculated according type detail specification “HQN-384-01/101: Technical Information Film Capacitors”, www.vishay.com/doc?28147.

The component temperature rise (ΔT) can be measured (see section “Measuring the component temperature” for more details) or calculated by $\Delta T = P/G$:

- ΔT = component temperature rise ($^{\circ}\text{C}$)
- P = power dissipation of the component (mW)
- G = heat conductivity of the component (mW/ $^{\circ}\text{C}$)

MEASURING THE COMPONENT TEMPERATURE

A thermocouple must be attached to the capacitor body as in:



The temperature is measured in unloaded (T_{amb}) and maximum loaded condition (T_{C}).

The temperature rise is given by $\Delta T = T_{\text{C}} - T_{\text{amb}}$.

To avoid radiation or convection, the capacitor should be tested in a wind-free box.

APPLICATION NOTE AND LIMITING CONDITIONS

These capacitors are not suitable for mains applications as across-the-line capacitors without additional protection, as described hereunder. These mains applications are strictly regulated in safety standards and therefore electromagnetic interference suppression capacitors conforming the standards must be used.

For capacitors connected in parallel, normally the proof voltage and possibly the rated voltage must be reduced. For information depending of the capacitance value and the number of parallel connections contact: dc-film@vishay.com

To select the capacitor for a certain application, the following conditions must be checked:

1. The peak voltage (U_{P}) shall not be greater than the rated DC voltage (U_{RDC})
2. The peak-to-peak voltage ($U_{\text{P-P}}$) shall not be greater than $2\sqrt{2} \times U_{\text{RAC}}$ to avoid the ionization inception level
3. The voltage peak slope (dU/dt) shall not exceed the rated voltage pulse slope in an RC-circuit at rated voltage and without ringing. If the pulse voltage is lower than the rated DC voltage, the rated voltage pulse slope may be multiplied by U_{RDC} and divided by the applied voltage.

For all other pulses following equation must be fulfilled:

$$2 \times \int_0^T \left(\frac{dU}{dt} \right)^2 \times \left(dt < U_{\text{RDC}} \times \left(\frac{dU}{dt} \right)_{\text{rated}} \right)$$

T is the pulse duration.

4. The maximum component surface temperature rise must be lower than the limits (see graph “Max. allowed component temperature rise”).
5. Since in circuits used at voltages over 280 V peak-to-peak the risk for an intrinsically active flammability after a capacitor breakdown (short circuit) increases, it is recommended that the power to the component is limited to 100 times the values mentioned in the table: “Heat Conductivity”
6. When using these capacitors as across-the-line capacitor in the input filter for mains applications or as series connected with an impedance to the mains the applicant must guarantee that the following conditions are fulfilled in any case (spikes and surge voltages from the mains included).

| VOLTAGE CONDITIONS FOR 6 ABOVE | | |
|--|--------------------------------|--|
| ALLOWED VOLTAGES | T_{amb} ≤ 85 °C | 85 °C < T_{amb} ≤ 105 °C |
| Maximum continuous RMS voltage | U _{RAC} | See "Max. AC voltage as function of temperature" per characteristics |
| Maximum temperature RMS-overvoltage (< 24 h) | 1.25 x U _{RAC} | U _{RAC} |
| Maximum peak voltage (V _{O-P}) (< 2 s) | 1.6 x U _{RDC} | 1.3 x U _{RDC} |

Example

C = 330 nF - 63 V used for the voltage signal shown in next drawing.

U_{P-P} = 40 V; U_P = 35 V; T₁ = 100 μs; T₂ = 200 μs

The ambient temperature is 35 °C

Checking conditions:

1. The peak voltage U_P = 35 V is lower than 63 V_{DC}
2. The peak-to-peak voltage 40 V is lower than $2\sqrt{2} \times 40 \text{ V}_{AC} = 113 \text{ U}_{P-P}$
3. The voltage pulse slope (dU/dt) = 40 V/100 μs = 0.4 V/μs
This is lower than 60 V/μs (see specific reference data for each version)
4. The dissipated power is 16.2 mW as calculated with fourier terms
The temperature rise for W_{max.} = 3.5 mm and pitch = 5 mm will be 16.2 mW/3.0 mW/°C = 5.4 °C
This is lower than 15 °C temperature rise at 35 °C, according figure "Max. allowed component temperature rise"
5. Not applicable
6. Not applicable

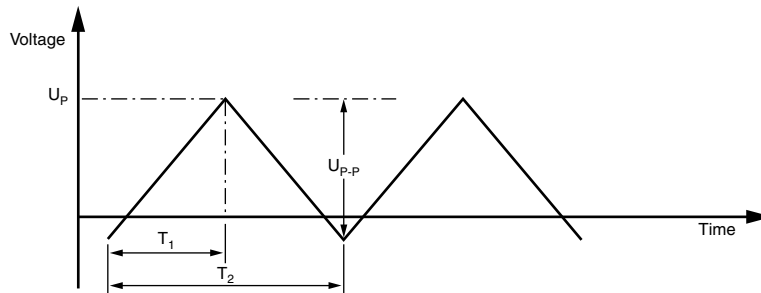
Voltage Signal

INSPECTION REQUIREMENTS
General Notes

Sub-clause numbers of tests and performance requirements refer to the "Sectional Specification, Publication IEC 60384-2 and Specific Reference Data".

| GROUP C INSPECTION REQUIREMENTS | | |
|--|--|---|
| SUB-CLAUSE NUMBER AND TEST | CONDITIONS | PERFORMANCE REQUIREMENTS |
| SUB-GROUP C-1A PART OF SAMPLE OF SUB-GROUP C1 | | |
| 4.1 Dimensions (detail) | | As specified in chapters "General Data" of this specification |
| 4.3.1 Initial measurements | Capacitance Tangent of loss angle: for C ≤ 470 nF at 100 kHz for 470 nF < C ≤ 10 μF at 10 kHz for C > 10 μF at 1 kHz | |
| 4.3 Robustness of terminations | Tensile and bending | No visible damage |
| 4.4 Resistance to soldering heat | Method: 1A Solder bath: 280 °C ± 5 °C Duration: 10 s | |



| GROUP C INSPECTION REQUIREMENTS | | |
|---|---|--|
| SUB-CLAUSE NUMBER AND TEST | CONDITIONS | PERFORMANCE REQUIREMENTS |
| SUB-GROUP C1A PART OF SAMPLE OF SUB-GROUP C1 | | |
| 4.14 Component solvent resistance | Isopropylalcohol at room temperature Method: 2 Immersion time: 5 min ± 0.5 min Recovery time: min. 1 h, max. 2 h | |
| 4.4.2 Final measurements | Visual examination Capacitance Tangent of loss angle | No visible damage Legible marking $ \Delta C/C \leq 2\%$ of the value measured initially Increase of $\tan \delta$ ≤ 0.005 for: $C \leq 100$ nF or ≤ 0.010 for: 100 nF < $C \leq 220$ nF or ≤ 0.015 for: 220 nF < $C \leq 470$ nF and ≤ 0.003 for: $C > 470$ nF Compared to values measured in 4.3.1 |
| SUB-GROUP C1B PART OF SAMPLE OF SUB-GROUP C1 | | |
| 4.6.1 Initial measurements | Capacitance Tangent of loss angle: for $C \leq 470$ nF at 100 kHz for 470 nF < $C \leq 10$ μ F at 10 kHz for $C > 10$ μ F at 1 kHz | No visible damage |
| 4.6 Rapid change of temperature | $\theta A = -55$ °C $\theta B = +105$ °C 5 cycles Duration $t = 30$ min | |
| 4.7 Vibration | Visual examination Mounting: see section "Mounting" of this specification Procedure B4 Frequency range: 10 Hz to 55 Hz Amplitude: 0.75 mm or Acceleration 98 m/s ² (whichever is less severe) Total duration 6 h | No visible damage |
| 4.7.2 Final inspection | Visual examination | No visible damage |
| 4.9 Shock | Mounting: see section "Mounting" of this specification Pulse shape: half sine Acceleration: 490 m/s ² Duration of pulse: 11 ms | |
| 4.9.3 Final measurements | Visual examination Capacitance Tangent of loss angle Insulation resistance | No visible damage $ \Delta C/C \leq 3\%$ of the value measured in 4.6.1 Increase of $\tan \delta$ ≤ 0.005 for: $C \leq 100$ nF or ≤ 0.010 for: 100 nF < $C \leq 220$ nF or ≤ 0.015 for: 220 nF < $C \leq 470$ nF and ≤ 0.003 for: $C > 470$ nF Compared to values measured in 4.6.1 As specified in section "Insulation Resistance" of this specification |



| GROUP C INSPECTION REQUIREMENTS | | |
|--|---|--|
| SUB-CLAUSE NUMBER AND TEST | CONDITIONS | PERFORMANCE REQUIREMENTS |
| SUB-GROUP C1 COMBINED SAMPLE OF SPECIMENS OF SUB-GROUPS C1A AND C1B | | |
| 4.10 Climatic sequence | | |
| 4.10.2 Dry heat | Temperature: +105 °C Duration: 16 h | |
| 4.10.3 Damp heat cyclic Test Db, first cycle | | |
| 4.10.4 Cold | Temperature: -55 °C Duration: 2 h | |
| 4.10.6 Damp heat cyclic Test Db, remaining cycles | | |
| 4.10.6.2 Final measurements | Voltage proof = U_{RDC} for 1 min within 15 min after removal from testchamber Visual examination Capacitance Tangent of loss angle Insulation resistance | No breakdown of flash-over No visible damage Legible marking $ \Delta C/C \leq 3\%$ of the value measured in 4.4.2 or 4.9.3 Increase of $\tan \delta$ ≤ 0.005 for: $C \leq 100$ nF or ≤ 0.010 for: 100 nF < $C \leq 220$ nF or ≤ 0.015 for: 220 nF < $C \leq 470$ nF and ≤ 0.005 for: $C > 470$ nF Compared to values measured in 4.3.1 or 4.6.1 $\geq 50\%$ of values specified in section "Insulation Resistance" of this specification |
| SUB-GROUP C2 | | |
| 4.11 Damp heat steady state | 56 days, 40 °C, 90 % to 95 % RH | |
| 4.11.1 Initial measurements | Capacitance Tangent of loss angle at 1 kHz | |
| 4.11.3 Final measurements | Voltage proof = U_{RDC} for 1 min within 15 min after removal from testchamber Visual examination Capacitance Tangent of loss angle Insulation resistance | No breakdown of flash-over No visible damage Legible marking $ \Delta C/C \leq 5\%$ of the value measured in 4.11.1. Increase of $\tan \delta \leq 0.005$ Compared to values measured in 4.11.1 $\geq 50\%$ of values specified in section "Insulation Resistance" of this specification |



| GROUP C INSPECTION REQUIREMENTS | | |
|---------------------------------|--|---|
| SUB-CLAUSE NUMBER AND TEST | CONDITIONS | PERFORMANCE REQUIREMENTS |
| SUB GROUP C3 | | |
| 4.12 Endurance | Duration: 2000 h 1.25 x U _{RDC} at 85 °C 0.8 x 1.25 U _{RDC} at 105 °C | |
| 4.12.1 Initial measurements | Capacitance Tangent of loss angle: for C ≤ 470 nF at 100 kHz for 470 nF < C ≤ 10 µF at 10 kHz for C > 10 µF at 1 kHz | |
| 4.12.5 Final measurements | Visual examination Capacitance Tangent of loss angle Insulation resistance | No visible damage Legible marking ΔC/C ≤ 5 % compared to values measured in 4.12.1 Increase of tan δ ≤ 0.005 for: C ≤ 100 nF or ≤ 0.010 for: 100 nF < C ≤ 220 nF or ≤ 0.015 for: 220 nF < C ≤ 470 nF and ≤ 0.003 for: C > 470 nF Compared to values measured in 4.12.1 ≥ 50 % of values specified in section "Insulation Resistance" of this specification |
| SUB-GROUP C4 | | |
| 4.13 Charge and discharge | 10 000 cycles Charged to U _{RDC} Discharge resistance: $R = \frac{U_R}{C \times 2.5 \times (dU/dt)_R}$ | |
| 4.13.1 Initial measurements | Capacitance Tangent of loss angle: for C ≤ 470 nF at 100 kHz for 470 nF < C ≤ 10 µF at 10 kHz for C > 10 µF at 1 kHz | |
| 4.13.3 Final measurements | Capacitance Tangent of loss angle Insulation resistance | ΔC/C ≤ 3 % compared to values measured in 4.13.1 Increase of tan δ ≤ 0.005 for: C ≤ 100 nF or ≤ 0.010 for: 100 nF < C ≤ 220 nF or ≤ 0.015 for: 220 nF < C ≤ 470 nF and ≤ 0.003 for: C > 470 nF Compared to values measured in 4.13.1 ≥ 50 % of values specified in section "Insulation Resistance" of this specification |



Disclaimer

ALL PRODUCT, PRODUCT SPECIFICATIONS AND DATA ARE SUBJECT TO CHANGE WITHOUT NOTICE TO IMPROVE RELIABILITY, FUNCTION OR DESIGN OR OTHERWISE.

Vishay Intertechnology, Inc., its affiliates, agents, and employees, and all persons acting on its or their behalf (collectively, "Vishay"), disclaim any and all liability for any errors, inaccuracies or incompleteness contained in any datasheet or in any other disclosure relating to any product.

Vishay makes no warranty, representation or guarantee regarding the suitability of the products for any particular purpose or the continuing production of any product. To the maximum extent permitted by applicable law, Vishay disclaims (i) any and all liability arising out of the application or use of any product, (ii) any and all liability, including without limitation special, consequential or incidental damages, and (iii) any and all implied warranties, including warranties of fitness for particular purpose, non-infringement and merchantability.

Statements regarding the suitability of products for certain types of applications are based on Vishay's knowledge of typical requirements that are often placed on Vishay products in generic applications. Such statements are not binding statements about the suitability of products for a particular application. It is the customer's responsibility to validate that a particular product with the properties described in the product specification is suitable for use in a particular application. Parameters provided in datasheets and / or specifications may vary in different applications and performance may vary over time. All operating parameters, including typical parameters, must be validated for each customer application by the customer's technical experts. Product specifications do not expand or otherwise modify Vishay's terms and conditions of purchase, including but not limited to the warranty expressed therein.

Except as expressly indicated in writing, Vishay products are not designed for use in medical, life-saving, or life-sustaining applications or for any other application in which the failure of the Vishay product could result in personal injury or death. Customers using or selling Vishay products not expressly indicated for use in such applications do so at their own risk. Please contact authorized Vishay personnel to obtain written terms and conditions regarding products designed for such applications.

No license, express or implied, by estoppel or otherwise, to any intellectual property rights is granted by this document or by any conduct of Vishay. Product names and markings noted herein may be trademarks of their respective owners.

X-ON Electronics

Largest Supplier of Electrical and Electronic Components

Click to view similar products for [Film Capacitors](#) category:

Click to view products by [Vishay](#) manufacturer:

Other Similar products are found below :

[F339X134748MIP2T0](#) [F450KG153J250ALH0J](#) [750-1018](#) [FKP1-1500160010P15](#) [FKP1R031007D00JYSD](#) [FKP1R031507E00JYSD](#)
[FKP1U024707E00KYSD](#) [82DC4100CK60J](#) [82EC1100DQ50K](#) [PFR5101J100J11L16.5TA18](#) [PME261JB5220KR19T0](#) [A451GK223M040A](#)
[A561ED221M450A](#) [QXJ2E474KTPT](#) [QXL2B333KTPT](#) [R49AN347000A1K](#) [EEC2G505HQA406](#) [B25668A6676A375](#) [B25673A4282E140](#)
[BFC233868148](#) [BFC2370GC222](#) [C3B2AD44400B20K](#) [C4ASWBU3220A3EK](#) [CB027C0473J--](#) [CB177I0184J--](#) [CB182K0184J--](#) [23PW210](#)
[950CQW5H-F](#) [SBDC3470AA10J](#) [SCD105K122A3-22](#) [2N3155](#) [A571EH331M450A](#) [FKP1-2202KV5P15](#) [FKS3-680040010P10](#)
[QXL2E473KTPT](#) [445450-1](#) [B25669A3996J375](#) [46KI322000M1M](#) [46KR415050M1K](#) [4BSNBX4100ZBFJ](#) [MKP383510063JKP2T0](#)
[MKPY2-.02230020P15](#) [MKT 1813-368-015](#) [4055292001](#) [46KN410000N1K](#) [EEC2E106HQA405](#) [EEC2G205HQA402](#) [EEC2G805HQA415](#)
[P409CP224M250AH470](#) [82EC2150DQ50K](#)