

Optocoupler, Phototransistor Output (Multichannel)

Dual Channel

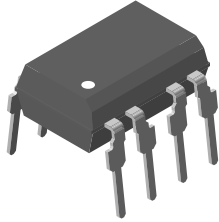

Quad Channel

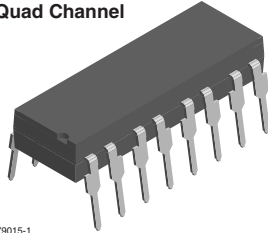

1179015-1

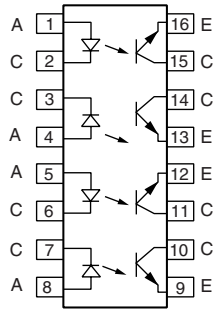
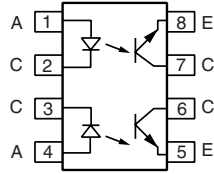

1179015-2



FEATURES

- CNY74-2H, CNY74-4H TTL compatible
- Transfer ratio, 35 % typical
- Coupling capacitance, 0.5 pF
- Dual and quad channel
- Industry standard DIP packages
- Compliant to RoHS directive 2002/95/EC and in accordance to WEEE 2002/96/EC



RoHS
COMPLIANT

AGENCY APPROVALS

- UL1577, file no. E52744 system code H, double protection
- UL1577, file no. E52744, equivalent to CSA bulletin 5A

DESCRIPTION

The CNY74-2H, CNY74-4H is an optically coupled pair with a GaAlAs infrared LED and a silicon NPN phototransistor. Signal information, including a DC level, can be transmitted by the device while maintaining a high degree of electrical isolation between input and output.

The CNY74-2H, CNY74-4H is especially for driving medium-speed logic, where it may be used to eliminate troublesome ground loop and noise problems. Also it can be used to replace relays and transformers in many digital interface applications, as well as analog applications such as CTR modulation.

The CNY74-2H has two isolated channels in a single DIP package; the CNY74-4H has four isolated channels per package.

ORDER INFORMATION

PART	REMARKS
CNY74-2H	CTR 50 % to 600 %, dual channel DIP-8
CNY74-4H	CTR 50 % to 600 %, quad channel DIP-16

ABSOLUTE MAXIMUM RATINGS

PARAMETER	TEST CONDITION	PART	SYMBOL	VALUE	UNIT
INPUT					
Peak reverse voltage			V_R	3	V
Forward continuous current			I_F	60	mA
Power dissipation			P_{diss}	100	mW
Derate linearly from 55 %				1.33	mW/°C

CNY74-2H, CNY74-4H



Vishay Semiconductors Optocoupler, Phototransistor Output
(Multichannel)

ABSOLUTE MAXIMUM RATINGS					
PARAMETER	TEST CONDITION	PART	SYMBOL	VALUE	UNIT
OUTPUT					
Collector emitter breakdown voltage			BV_{CEO}	70	V
Emitter collector breakdown voltage			BV_{ECO}	7	V
Power dissipation			P_{diss}	150	mW
Derate linearly from 25 °C				2	mW/°C
COUPLER					
Isolation test voltage	$t = 1 \text{ s}$		V_{ISO}	5300	V_{RMS}
Isolation resistance	$V_{IO} = 500 \text{ V}, T_{amb} = 25 \text{ °C}$		R_{IO}	$\geq 10^{12}$	Ω
	$V_{IO} = 500 \text{ V}, T_{amb} = 100 \text{ °C}$		R_{IO}	$\geq 10^{11}$	Ω
Total package dissipation		CNY74-2H	P_{tot}	400	mW
		CNY74-4H	P_{tot}	500	mW
Derate linearly from 25 °C		CNY74-2H		5.33	mW/°C
		CNY74-4H		6.67	mW/°C
Creepage distance				≥ 7	mm
Clearance distance				≥ 7	mm
Storage temperature			T_{stg}	- 55 to + 150	°C
Operating temperature			T_{amb}	- 55 to + 100	°C
Lead soldering time at 260 °C				10	s

Note

$T_{amb} = 25 \text{ °C}$, unless otherwise specified.

Stresses in excess of the absolute maximum ratings can cause permanent damage to the device. Functional operation of the device is not implied at these or any other conditions in excess of those given in the operational sections of this document. Exposure to absolute maximum ratings for extended periods of the time can adversely affect reliability.

ELECTRICAL CHARACTERISTICS						
PARAMETER	TEST CONDITION	SYMBOL	MIN.	TYP.	MAX.	UNIT
INPUT						
Forward voltage	$I_F = 20 \text{ mA}$	V_F		1.3	1.5	V
Reverse current	$V_R = 3 \text{ V}$	I_R		0.1	100	μA
Capacitance	$V_R = 0 \text{ V}$	C_O		25		pF
OUTPUT						
Collector emitter breakdown voltage	$I_C = 1 \text{ mA}$	BV_{CEO}	70			V
Collector emitter leakage current	$V_{CE} = 5 \text{ V}, I_F = 0 \text{ A}$	I_{CEO}			100	nA
Capacitance collector emitter	$V_{CE} = 0 \text{ V}, f = 1 \text{ Hz}$	C_{CE}		10		pF
COUPLER						
Saturation voltage, collector emitter	$I_C = 2 \text{ mA}, I_F = 16 \text{ mA}$	V_{CEsat}		0.3	0.5	V
Resistance (input to output)		R_{IO}		100		$G\Omega$
Capacitance (input to output)		C_{IO}		0.5		pF

Note

$T_{amb} = 25 \text{ °C}$, unless otherwise specified.

Minimum and maximum values are testing requirements. Typical values are characteristics of the device and are the result of engineering evaluation. Typical values are for information only and are not part of the testing requirements.

CURRENT TRANSFER RATIO						
PARAMETER	TEST CONDITION	SYMBOL	MIN.	TYP.	MAX.	UNIT
DC current transfer ratio	$I_F = 5 \text{ mA}, V_{CE} = 5 \text{ V}$	CTR	50		600	%
DC current transfer ratio	$I_F = 10 \text{ mA}, V_{CE} = 5 \text{ V}$	CTR	60			%

SWITCHING CHARACTERISTICS						
PARAMETER	TEST CONDITION	SYMBOL	MIN.	TYP.	MAX.	UNIT
Delay time	$V_S = 5\text{ V}$, $I_C = 2\text{ mA}$, $R_L = 100\ \Omega$ (see figure 1)	t_d		3		μs
Rise time	$V_S = 5\text{ V}$, $I_C = 2\text{ mA}$, $R_L = 100\ \Omega$ (see figure 1)	t_r		3		μs
Fall time	$V_S = 5\text{ V}$, $I_C = 2\text{ mA}$, $R_L = 100\ \Omega$ (see figure 1)	t_f		4.7		μs
Storage time	$V_S = 5\text{ V}$, $I_C = 2\text{ mA}$, $R_L = 100\ \Omega$ (see figure 1)	t_s		0.3		μs
Turn-on time	$V_S = 5\text{ V}$, $I_C = 2\text{ mA}$, $R_L = 100\ \Omega$ (see figure 1)	t_{on}		6		μs
Turn-off time	$V_S = 5\text{ V}$, $I_C = 2\text{ mA}$, $R_L = 100\ \Omega$ (see figure 1)	t_{off}		5		μs
Turn-on time	$V_S = 5\text{ V}$, $I_C = 10\text{ mA}$, $R_L = 1\text{ k}\Omega$ (see figure 2)	t_{on}		9		μs
Turn-off time	$V_S = 5\text{ V}$, $I_C = 10\text{ mA}$, $R_L = 1\text{ k}\Omega$ (see figure 2)	t_{off}		18		μs



Fig. 1 - Test Circuit, Non-Saturated Operation



Fig. 3 - Switching Times



Fig. 2 - Test Circuit, Saturated Operation

TYPICAL CHARACTERISTICS

$T_{amb} = 25\text{ }^{\circ}\text{C}$, unless otherwise specified



Fig. 4 - Forward Voltage vs. Forward Current



Fig. 7 - Normalized Non-Saturated and Saturated CTR vs. LED Current



Fig. 5 - Normalized Non-Saturated and Saturated CTR vs. LED Current



Fig. 8 - Normalized Non-Saturated and Saturated CTR vs. LED Current



Fig. 6 - Normalized Non-Saturated and Saturated CTR vs. LED Current

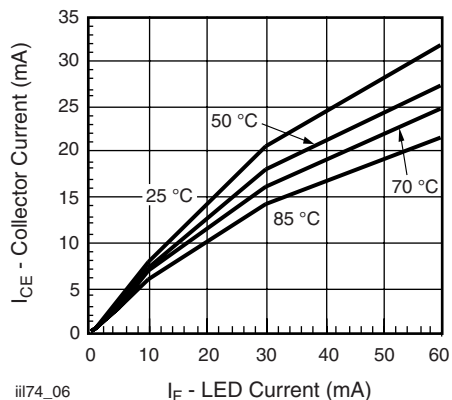

Fig. 9 - Collector Emitter Current vs. Temperature and LED Current

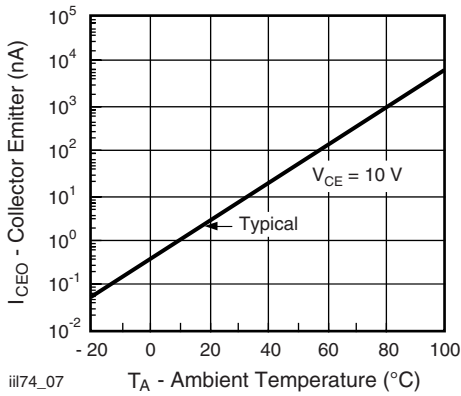

Fig. 10 - Collector Emitter Leakage Current vs. Temperature

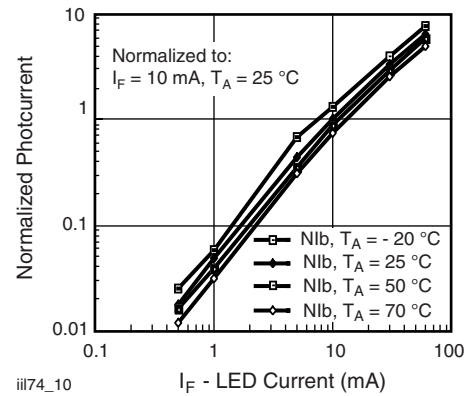

Fig. 13 - Normalized Photocurrent vs. I_F and Temperature

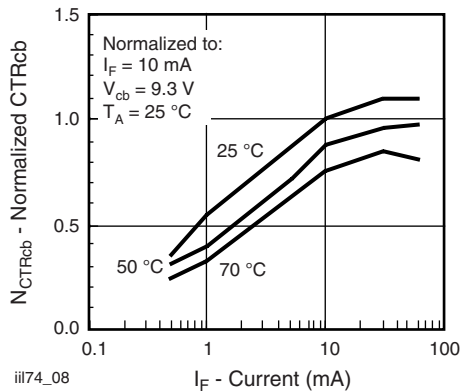

Fig. 11 - Normalized CTR_{cb} vs. LED Current and Temperature

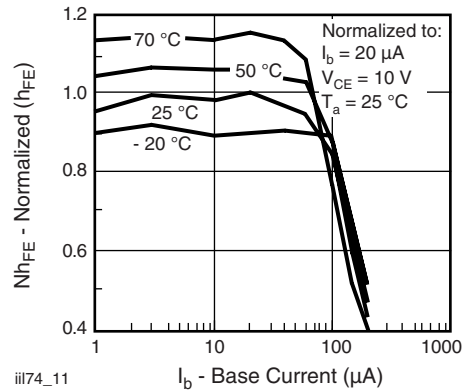

Fig. 14 - Normalized Non-Saturated h_{FE} vs. Base Current and Temperature

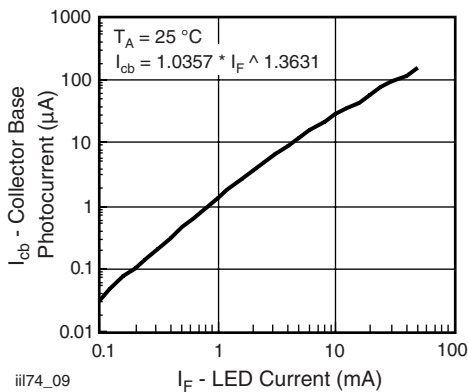

Fig. 12 - Collector Base Photocurrent vs. LED Current

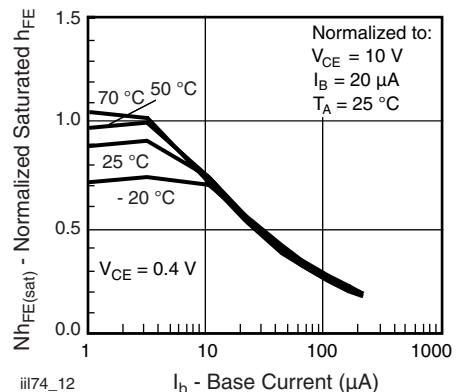

Fig. 15 - Normalized Saturated h_{FE} vs. Base Current and Temperature

CNY74-2H, CNY74-4H



Vishay Semiconductors Optocoupler, Phototransistor Output
(Multichannel)



iii74_13 R_L - Collector Load Resistor (K Ω)

Fig. 16 - Propagation Delay vs. Collector Load Resistor

PACKAGE DIMENSIONS in millimeters

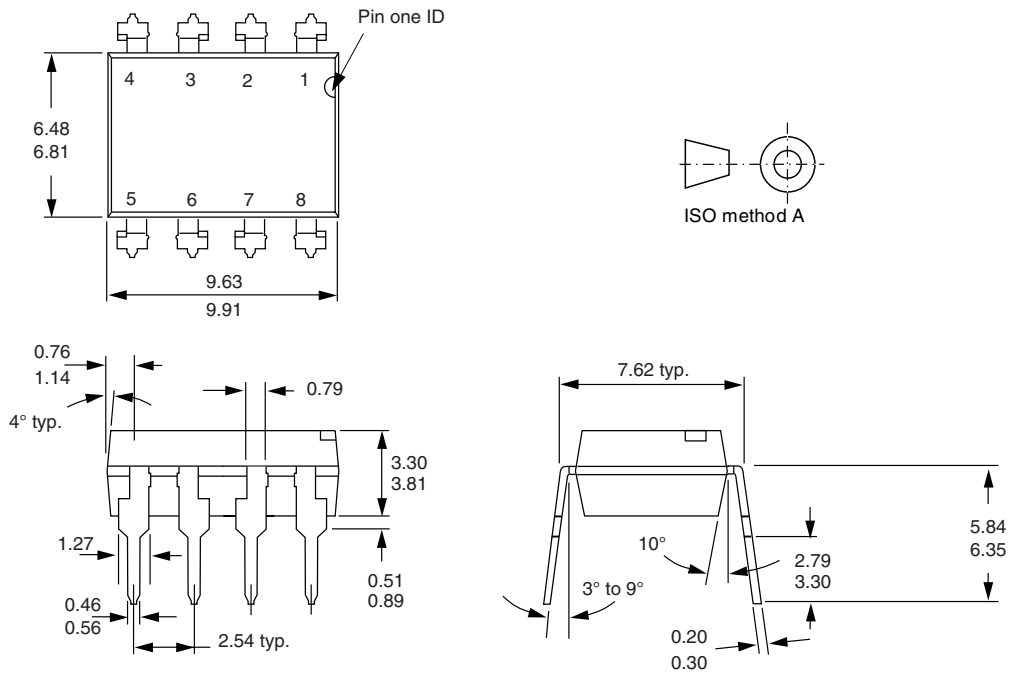

i178006



CNY74-2H, CNY74-4H

Optocoupler, Phototransistor Output Vishay Semiconductors
(Multichannel)

PACKAGE DIMENSIONS in millimeters

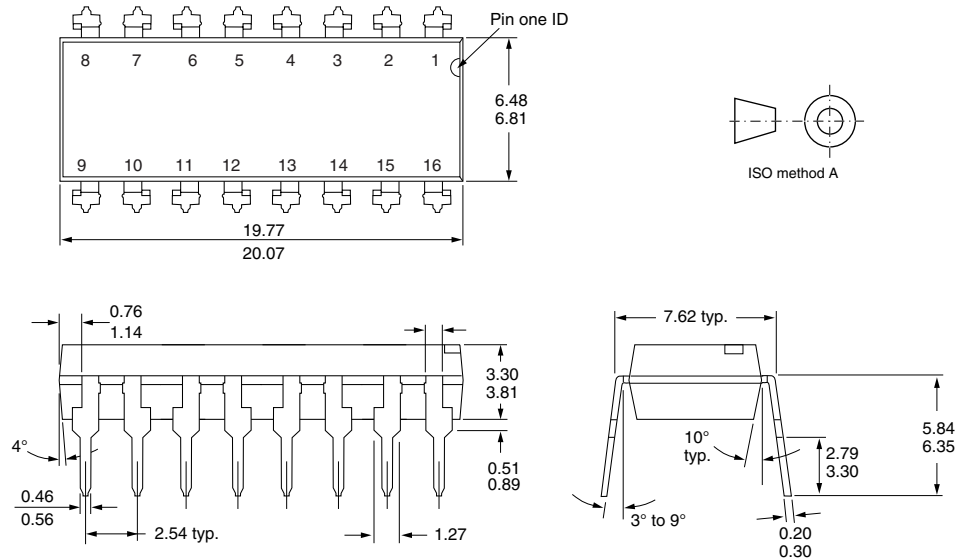

i178007

PACKAGE MARKING



21764-19

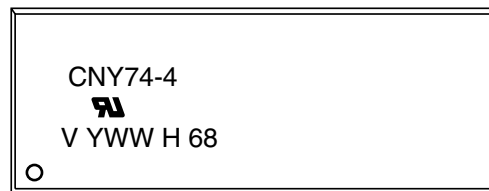

21764-20

Note

CNY74-2H and CNY74-4H are marked as CNY74-2 and CNY74-4 respectively.



Disclaimer

ALL PRODUCT, PRODUCT SPECIFICATIONS AND DATA ARE SUBJECT TO CHANGE WITHOUT NOTICE TO IMPROVE RELIABILITY, FUNCTION OR DESIGN OR OTHERWISE.

Vishay Intertechnology, Inc., its affiliates, agents, and employees, and all persons acting on its or their behalf (collectively, "Vishay"), disclaim any and all liability for any errors, inaccuracies or incompleteness contained in any datasheet or in any other disclosure relating to any product.

Vishay makes no warranty, representation or guarantee regarding the suitability of the products for any particular purpose or the continuing production of any product. To the maximum extent permitted by applicable law, Vishay disclaims (i) any and all liability arising out of the application or use of any product, (ii) any and all liability, including without limitation special, consequential or incidental damages, and (iii) any and all implied warranties, including warranties of fitness for particular purpose, non-infringement and merchantability.

Statements regarding the suitability of products for certain types of applications are based on Vishay's knowledge of typical requirements that are often placed on Vishay products in generic applications. Such statements are not binding statements about the suitability of products for a particular application. It is the customer's responsibility to validate that a particular product with the properties described in the product specification is suitable for use in a particular application. Parameters provided in datasheets and/or specifications may vary in different applications and performance may vary over time. All operating parameters, including typical parameters, must be validated for each customer application by the customer's technical experts. Product specifications do not expand or otherwise modify Vishay's terms and conditions of purchase, including but not limited to the warranty expressed therein.

Except as expressly indicated in writing, Vishay products are not designed for use in medical, life-saving, or life-sustaining applications or for any other application in which the failure of the Vishay product could result in personal injury or death. Customers using or selling Vishay products not expressly indicated for use in such applications do so at their own risk. Please contact authorized Vishay personnel to obtain written terms and conditions regarding products designed for such applications.

No license, express or implied, by estoppel or otherwise, to any intellectual property rights is granted by this document or by any conduct of Vishay. Product names and markings noted herein may be trademarks of their respective owners.

Material Category Policy

Vishay Intertechnology, Inc. hereby certifies that all its products that are identified as RoHS-Compliant fulfill the definitions and restrictions defined under Directive 2011/65/EU of The European Parliament and of the Council of June 8, 2011 on the restriction of the use of certain hazardous substances in electrical and electronic equipment (EEE) - recast, unless otherwise specified as non-compliant.

Please note that some Vishay documentation may still make reference to RoHS Directive 2002/95/EC. We confirm that all the products identified as being compliant to Directive 2002/95/EC conform to Directive 2011/65/EU.

Vishay Intertechnology, Inc. hereby certifies that all its products that are identified as Halogen-Free follow Halogen-Free requirements as per JEDEC JS709A standards. Please note that some Vishay documentation may still make reference to the IEC 61249-2-21 definition. We confirm that all the products identified as being compliant to IEC 61249-2-21 conform to JEDEC JS709A standards.

X-ON Electronics

Largest Supplier of Electrical and Electronic Components

Click to view similar products for [Transistor Output Optocouplers](#) category:

Click to view products by [Vishay](#) manufacturer:

Other Similar products are found below :

[LTV-814S-TA](#) [LTV-824HS](#) [LTV-852S](#) [66095-001](#) [6N136-X017T](#) [MCT6-X007](#) [MOC8101-X017T](#) [PS2561A-1-W-A](#) [PS2561B-1-L-A](#)
[PS2561L-1-V-A](#) [MRF658](#) [IL755-1X007](#) [ILD74-X001](#) [ILQ615-2X017](#) [ILQ615-3X016](#) [LDA102S](#) [LDA110S](#) [PS2561-1-V-W-A](#) [PS2561AL-1-V-A](#) [PS2561L1-1-L-A](#) [PS2701A-1-F3-P-A](#) [PS2801-1-F3-P-A](#) [PS2911-1-L-AX](#) [CNY17-2X017](#) [CNY17-4X001](#) [CNY17-4X017](#) [CNY17F-1X007](#) [CNY17F-2X017](#) [CNY17F-4X001](#) [CNY17G-1](#) [LTV-214](#) [LTV-702VB](#) [LTV-733S](#) [LTV-816S-TA](#) [LTV-825S](#) [TCET1113](#) [TCET2100](#)
[4N25-X007T](#) [IL215AT](#) [ILD615-1X007](#) [ILQ2-X007](#) [VOS615A-2T](#) [WPPC-A11066AA](#) [WPPC-A11066AD](#) [WPPC-A11084ASS](#) [WPPC-A21068AA](#) [WPPC-D11066AA](#) [WPPC-D21068ED](#) [WPPC-D410616EA](#) [WPPC-D410616ED](#)