

## High Current, Through-Hole Inductor, Edge-Wound Series



### APPLICATIONS

- High current and high temperature applications
- DC/DC converters
- High current differential mode chokes
- Inverters

### FEATURES

- High temperature operation, up to 180 °C continuous with no aging
- Low DCR to minimize losses and reduce temperature rise
- Powdered iron alloy core technology provides stable inductance and saturation over operating temperature with satisfactory core losses
- Soft saturation gives predictable inductance decrease with increasing DC current independent of temperature
- Series includes multiple powdered iron core materials for optimized performance in circuit application
- Standard terminal is stripped and tinned for through-hole mounting but other terminal configurations such as bare copper, SMD, and press fit pin are available upon request
- Hot dipped Sn plating provides low risk of whisker growth
- Custom options for inductance, current rating, DCR, mounting style and voltage rating are available
- Material categorization: for definitions of compliance please see [www.vishay.com/doc?99912](http://www.vishay.com/doc?99912)



**RoHS**  
COMPLIANT  
HALOGEN  
**FREE**  
**GREEN**  
(5-2008)

### STANDARD ELECTRICAL SPECIFICATIONS

PART NUMBER	L <sub>0</sub> INDUCTANCE ± 20 % AT 100 kHz, 0.25 V, 0 A (µH)	DCR AT 25 °C TYP. (mΩ)	DCR AT 25 °C MAX. (mΩ)	HEAT RATING CURRENT DC TYP. <sup>(1)</sup> (A)	SATURATION CURRENT DC		SRF TYP. (MHZ)	DIMENSION	
					TYP. <sup>(2)</sup> (A)	TYP. <sup>(3)</sup> (A)		A ± 0.8 [mm]	B ± 0.3 [mm]
<b>BEST BALANCE OF CORE LOSS AND SATURATION</b>									
IHDM1107BBEVR47M20	0.47	0.25	0.30	128	343	422	217	11.50	2.60
IHDM1107BBEV1R1M20	1.1	0.34	0.41	93	245	301	100	11.50	2.60
IHDM1107BBEV2R0M20	2.0	0.54	0.65	75	191	234	82	12.10	2.00
IHDM1107BBEV3R0M20	3.0	0.81	0.97	50	156	192	53	12.50	1.60
IHDM1107BBEV4R3M20	4.3	1.08	1.30	48	133	164	33	13.00	1.50
IHDM1107BBEV5R6M20	5.6	1.44	1.73	37	115	142	30	12.90	1.20
IHDM1107BBEV7R5M20	7.5	2.17	2.60	31	96	118	29	13.20	0.90
<b>LOWEST CORE LOSS</b>									
IHDM1107BBEVR68M30	0.68	0.25	0.30	125	202	248	181	11.50	2.60
IHDM1107BBEV1R5M30	1.5	0.34	0.41	91	134	165	80	11.50	2.60
IHDM1107BBEV2R7M30	2.7	0.54	0.65	72	103	127	62	12.10	2.00
IHDM1107BBEV4R3M30	4.3	0.81	0.97	64	85	105	44	12.50	1.60
IHDM1107BBEV6R2M30	6.2	1.08	1.30	56	74	91	25	13.00	1.50
IHDM1107BBEV8R2M30	8.2	1.44	1.73	39	59	73	22	12.90	1.20
IHDM1107BBEV120M30	12.0	2.17	2.60	35	49	61	21	13.20	0.90

### Notes

- The -20 series provides a good balance between core losses, saturation current, and high frequency stability up to 800 kHz
  - The -30 series provides lower core losses with slightly lower saturation current
  - All test data is referenced to 25 °C ambient
  - Operating temperature range -55 °C to +180 °C
  - The part temperature (ambient + temp. rise) should not exceed 180 °C under worst case operating conditions. Circuit design, component placement, PWB trace size and thickness, airflow and other cooling provisions all affect the part temperature. Part temperature should be verified in the end application
  - Isolation voltage, coil to core: 350 V<sub>DC</sub>, 60 s, 5 mA max.
- (1) DC current (A) that will cause an approximate ΔT of 40 °C  
 (2) DC current (A) that will cause L<sub>0</sub> to drop approximately 20 %  
 (3) DC current (A) that will cause L<sub>0</sub> to drop approximately 30 %

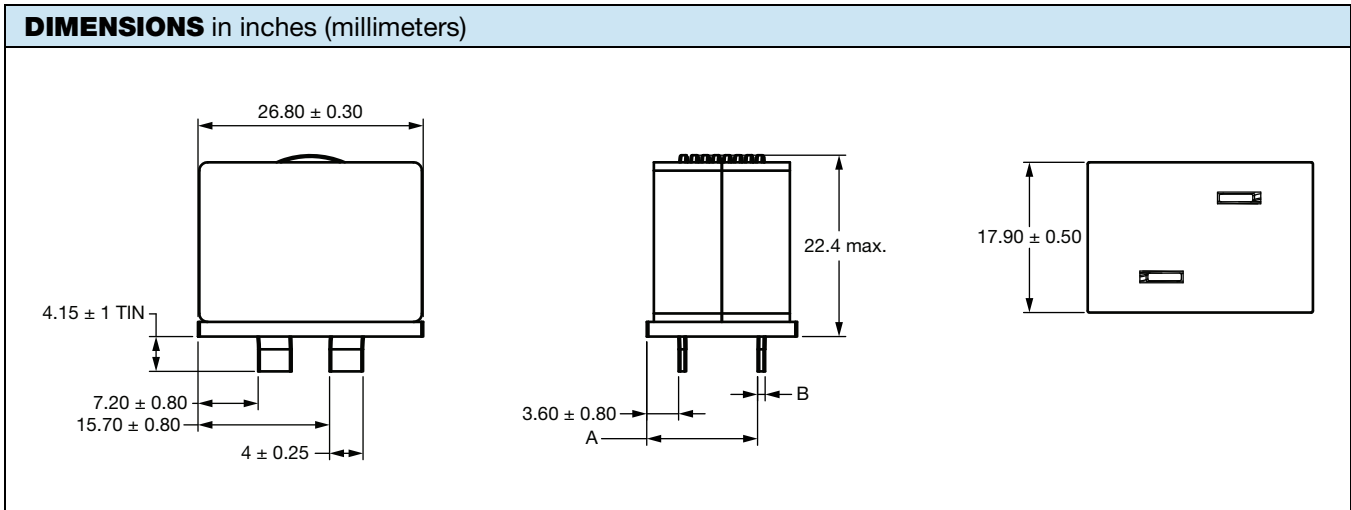

DESCRIPTION				
IHDM-1107BB-30	1.2 $\mu\text{H}$	$\pm 20 \%$	EV	e3
MODEL	INDUCTANCE	INDUCTANCE TOLERANCE	PACKAGE	JEDEC® LEAD (Pb)-FREE STANDARD

GLOBAL PART NUMBER																	
I	H	D	M	1	1	0	7	B	B	E	V	1	R	2	M	3	0
MODEL				SIZE					LEAD (Pb)-FREE	STYLE V: vertical	INDUCTANCE VALUE			TOL.	SERIES		



PERFORMANCE GRAPHS

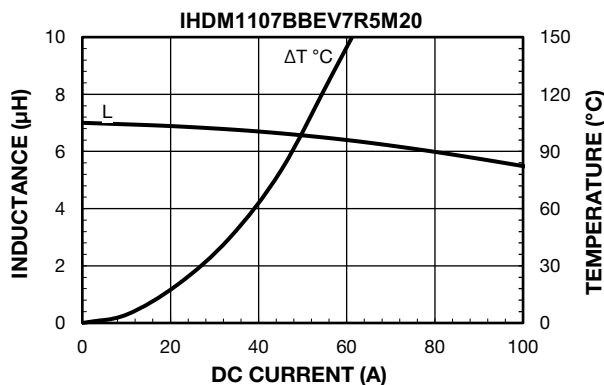
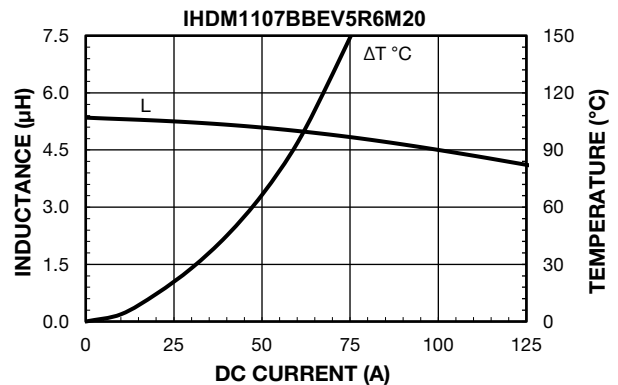
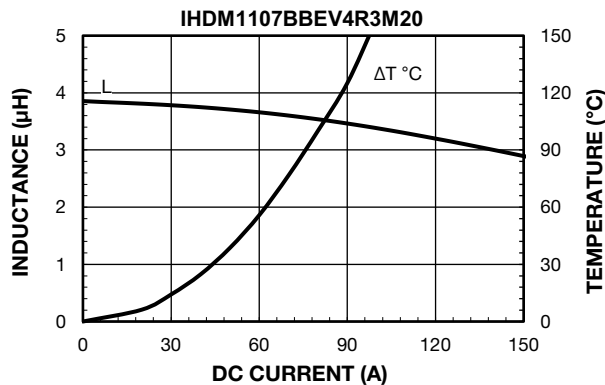
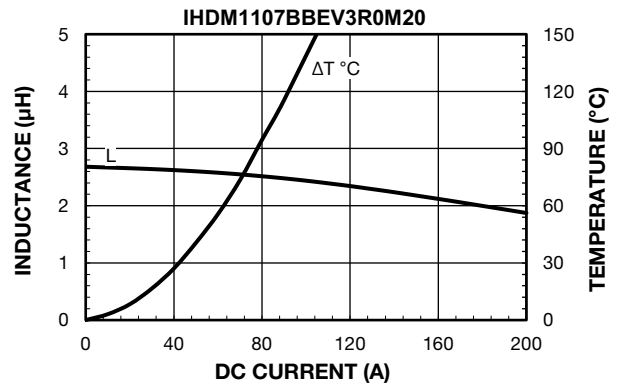
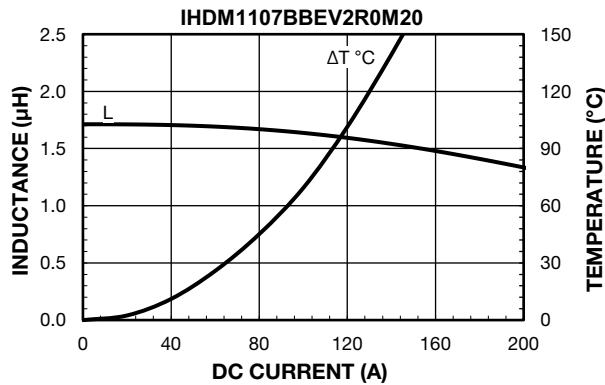
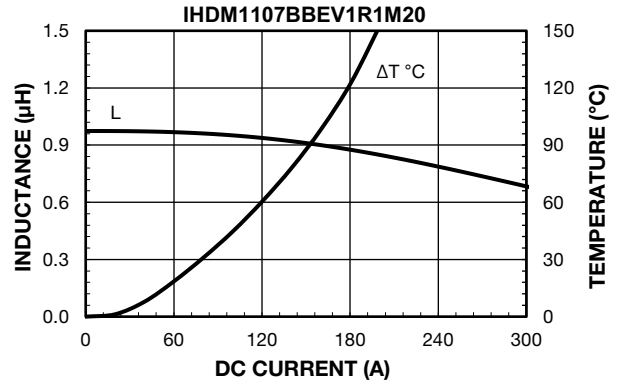
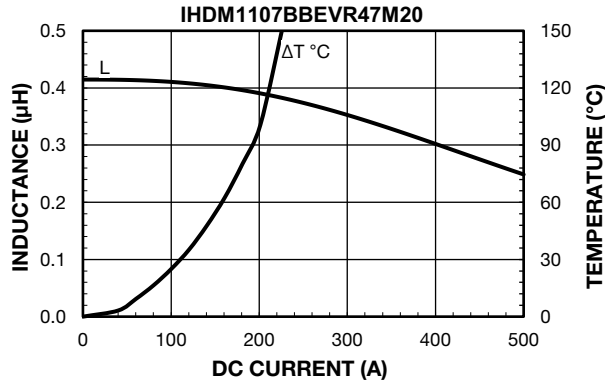



PERFORMANCE GRAPHS

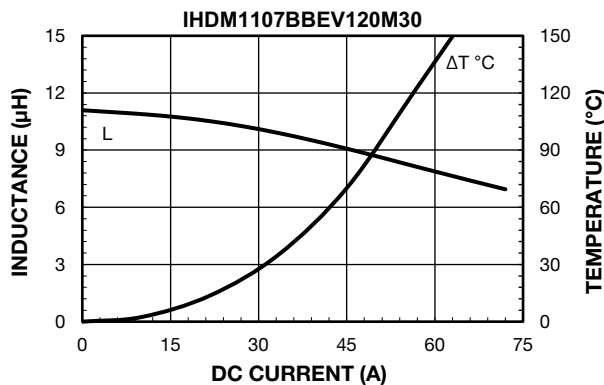
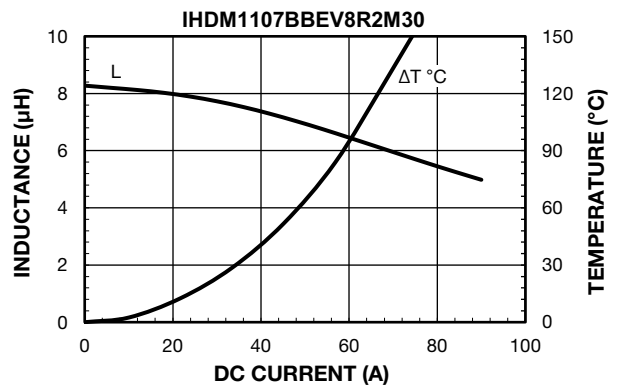
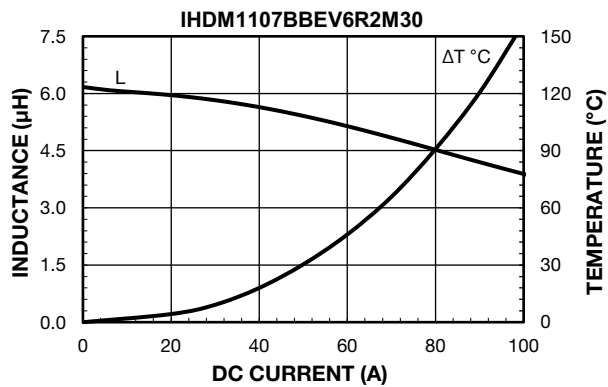
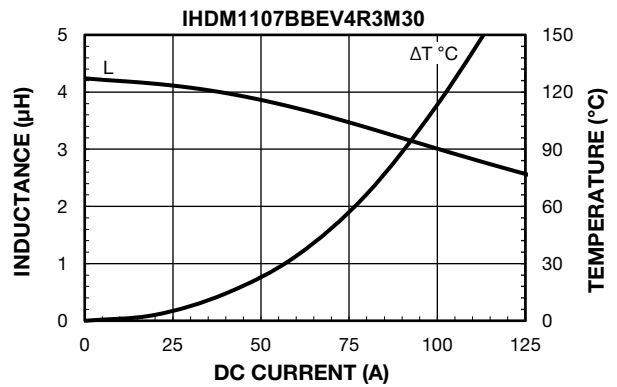
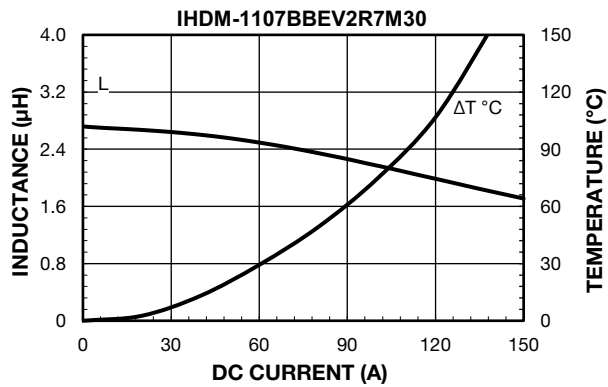
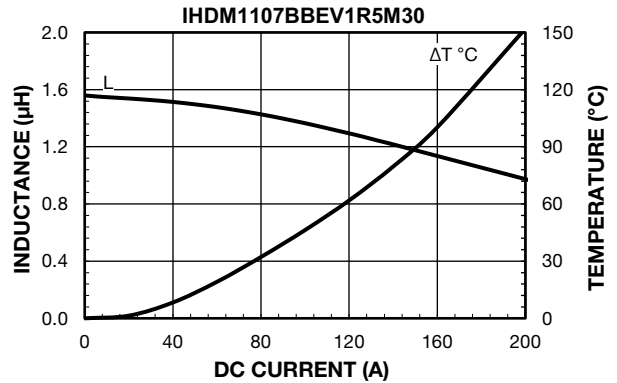
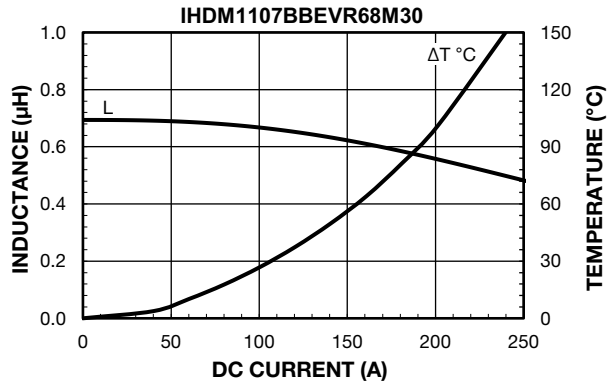



PERFORMANCE GRAPHS: INDUCTANCE AND Q VS. FREQUENCY

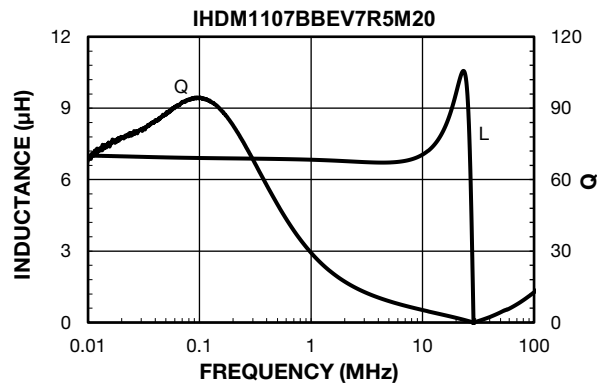
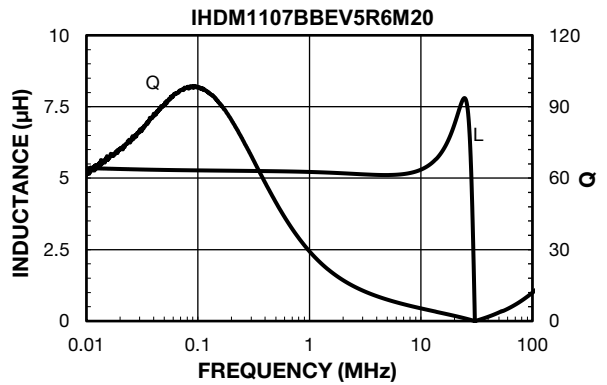
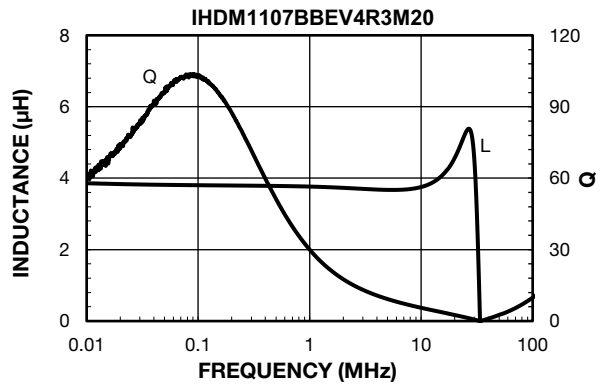
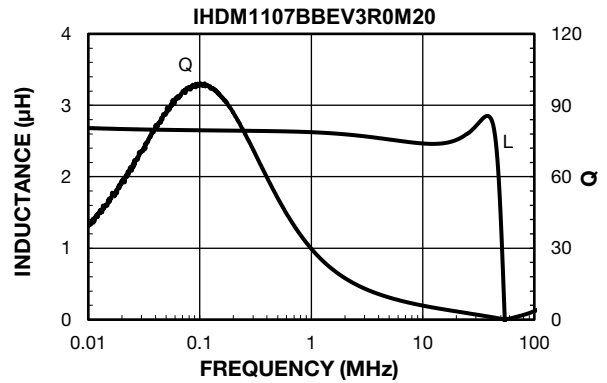
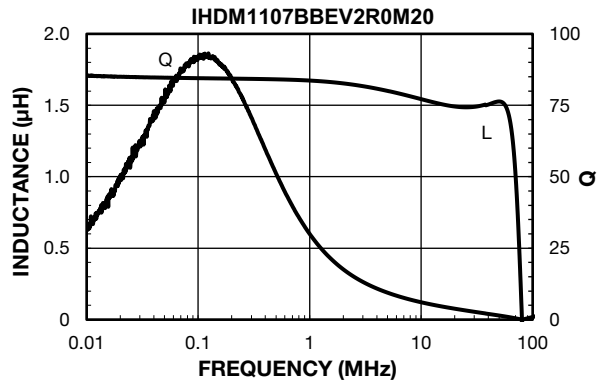
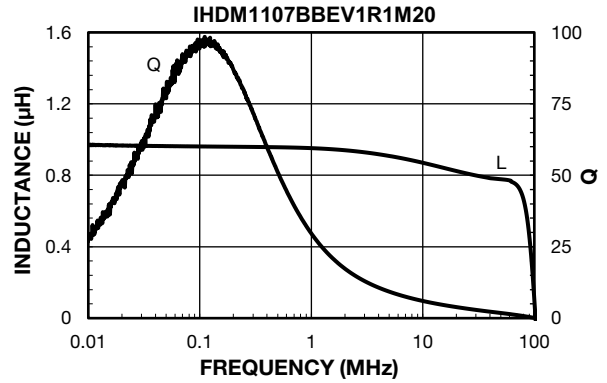
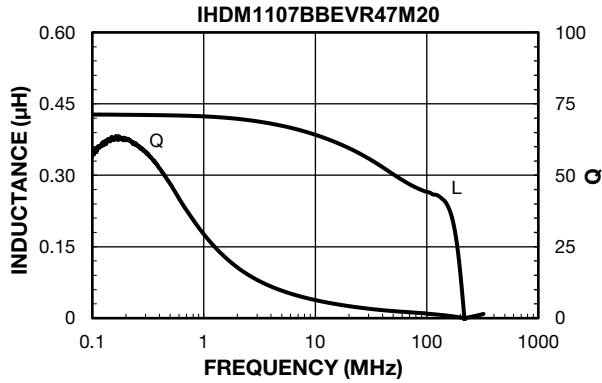



PERFORMANCE GRAPHS: INDUCTANCE AND Q VS. FREQUENCY

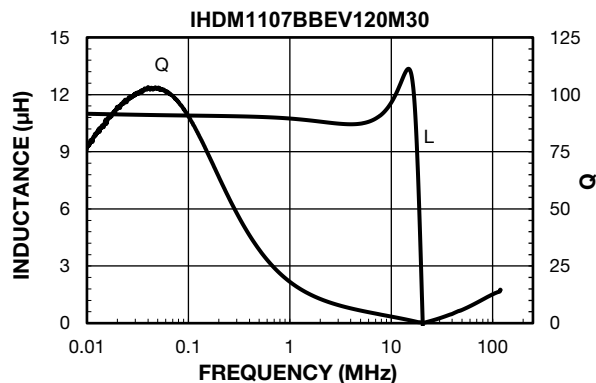
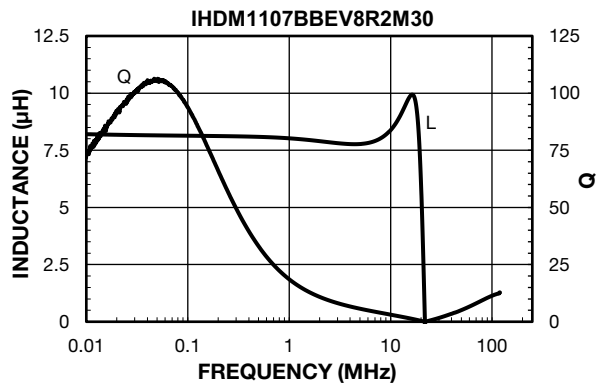
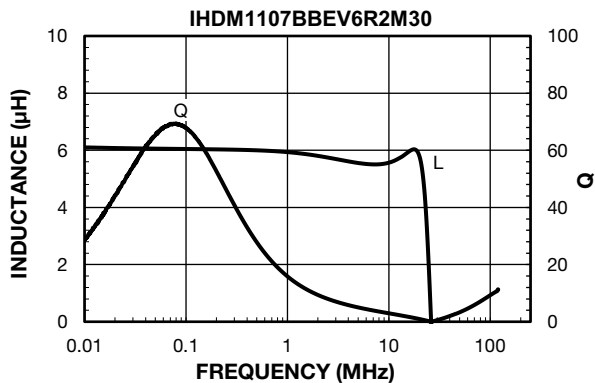
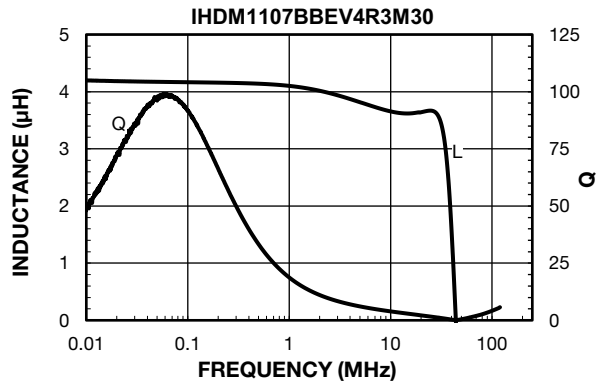
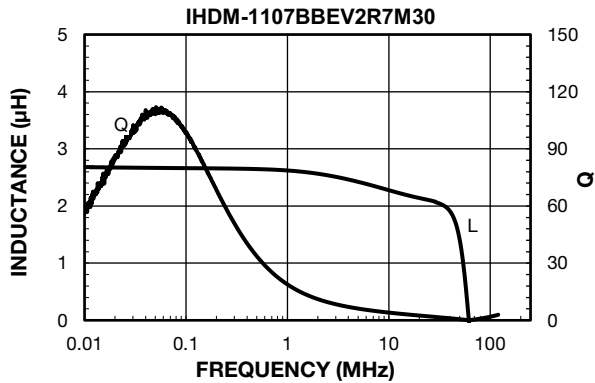
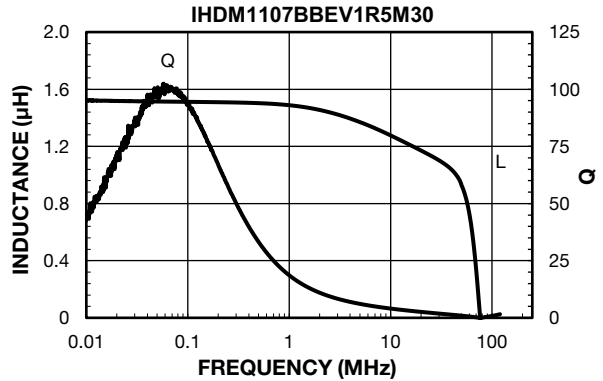
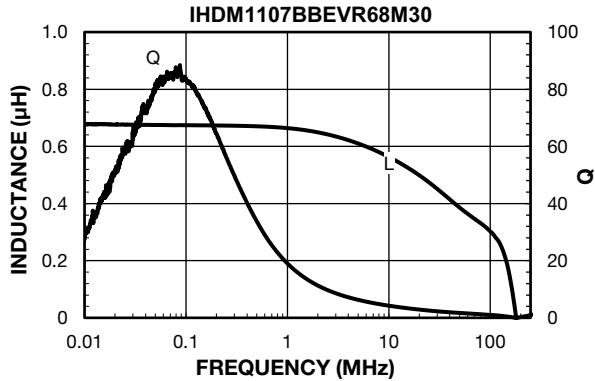



## **Disclaimer**

ALL PRODUCT, PRODUCT SPECIFICATIONS AND DATA ARE SUBJECT TO CHANGE WITHOUT NOTICE TO IMPROVE RELIABILITY, FUNCTION OR DESIGN OR OTHERWISE.

Vishay Intertechnology, Inc., its affiliates, agents, and employees, and all persons acting on its or their behalf (collectively, "Vishay"), disclaim any and all liability for any errors, inaccuracies or incompleteness contained in any datasheet or in any other disclosure relating to any product.

Vishay makes no warranty, representation or guarantee regarding the suitability of the products for any particular purpose or the continuing production of any product. To the maximum extent permitted by applicable law, Vishay disclaims (i) any and all liability arising out of the application or use of any product, (ii) any and all liability, including without limitation special, consequential or incidental damages, and (iii) any and all implied warranties, including warranties of fitness for particular purpose, non-infringement and merchantability.

Statements regarding the suitability of products for certain types of applications are based on Vishay's knowledge of typical requirements that are often placed on Vishay products in generic applications. Such statements are not binding statements about the suitability of products for a particular application. It is the customer's responsibility to validate that a particular product with the properties described in the product specification is suitable for use in a particular application. Parameters provided in datasheets and / or specifications may vary in different applications and performance may vary over time. All operating parameters, including typical parameters, must be validated for each customer application by the customer's technical experts. Product specifications do not expand or otherwise modify Vishay's terms and conditions of purchase, including but not limited to the warranty expressed therein.

Hyperlinks included in this datasheet may direct users to third-party websites. These links are provided as a convenience and for informational purposes only. Inclusion of these hyperlinks does not constitute an endorsement or an approval by Vishay of any of the products, services or opinions of the corporation, organization or individual associated with the third-party website. Vishay disclaims any and all liability and bears no responsibility for the accuracy, legality or content of the third-party website or for that of subsequent links.

Except as expressly indicated in writing, Vishay products are not designed for use in medical, life-saving, or life-sustaining applications or for any other application in which the failure of the Vishay product could result in personal injury or death. Customers using or selling Vishay products not expressly indicated for use in such applications do so at their own risk. Please contact authorized Vishay personnel to obtain written terms and conditions regarding products designed for such applications.

No license, express or implied, by estoppel or otherwise, to any intellectual property rights is granted by this document or by any conduct of Vishay. Product names and markings noted herein may be trademarks of their respective owners.

## X-ON Electronics

Largest Supplier of Electrical and Electronic Components

*Click to view similar products for [Fixed Inductors](#) category:*

*Click to view products by [Vishay](#) manufacturer:*

Other Similar products are found below :

[CR43NP-680KC](#) [CR54NP-820KC](#) [CR54NP-8R5MC](#) [CTX32CT-100](#) [70F224AI](#) [MGDQ4-00004-P](#) [MHL1ECTTP18NJ](#) [MHL1JCTTD12NJ](#)  
[PE-51506NL](#) [PE-53601NL](#) [PE-53602NL](#) [PE-53630NL](#) [PE-53824SNLT](#) [PE-62892NL](#) [PE-92100NL](#) [PG0434.801NLT](#) [PG0936.113NLT](#)  
[9310-16](#) [PM06-2N7](#) [PM06-39NJ](#) [A01TK](#) [1206CS-471XJ](#) [HC2-2R2TR](#) [HC2LP-R47-R](#) [HC3-2R2-R](#) [1206CS-151XG](#) [RCH664NP-140L](#)  
[RCH664NP-4R7M](#) [RCH8011NP-221L](#) [RCP1317NP-332L](#) [RCP1317NP-391L](#) [RCR1010NP-470M](#) [RCR110DNP-331L](#) [DH2280-4R7M](#)  
[DS1608C-106](#) [ASPI-4020HI-R10M-T](#) [B10TJ](#) [B82477P4333M](#) [B82498B3101J000](#) [B82498B3680J000](#) [ELJ-RE27NJF2](#) [1812CS-153XJ](#)  
[1812CS-183XJ](#) [1812CS-223XJ](#) [1812LS-104XJ](#) [1812LS-105XJ](#) [1812LS-124XJ](#) [1812LS-154XJ](#) [1812LS-223XJ](#) [1812LS-224XJ](#)